

# **NETWORK VIDEO RECORDER**

## **USER MANUAL**

### **Document Control**

Version : 1.0

Effective Date : 05.03.2024

Next Review Date : 05.03.2025

## About This Document

### Purpose

This document describes in detail the installation, use, and interface operations of the NVR (Network Video Recorder) device.






### Inteded Audience

This document is intended for:

- Technical support engineers
- Maintenance engineers
- Surveillance operators

### Symbol Conventions

The symbols may be found in this document, which are defined as follows:

| Symbol   | Description   |
|--|---|
|  <b>DANGER</b>  | Alerts you to a high risk hazard that could, if not avoided   |
|  <b>WARNING</b> | Alerts you to a medium or low risk hazard that could, if not avoided, result in moderate or minor injury.   |
|  <b>CAUTION</b> | Alerts you to a potentially hazardous situation that could, if not avoided, result in equipment damage, data loss, performance deterioration, or unanticipated results. |
|  <b>TIP</b>     | Provides a tip that may help you solve a problem or save time.  |
|  <b>NOTE</b>    | Provides additional information to emphasize or supplement important points in the main text.   |

### Special Announcement

This manual may contain misprints, technology information that is not accurate enough, or product function and operation description that is slightly inconsistent with the actual product. The manufacturer will update this manual according to product function enhancement or changes and regularly update the software and hardware described in this manual. Update information will be added to new versions of this manual without prior notice. This manual is only for reference and does not ensure that the information is totally consistent with the actual product. For consistency, see the actual product

## Safety instructions

The following are the correct use of the product. In order to prevent danger and prevent property damage, please read this manual carefully before using the device and strictly comply that when using it. Please save the manual after reading.

### Requirements

The front-end devices of PoE are required to be installed indoors.

The NVR device does not support wall mounting.

Do not place and install the device in direct sunlight or near heat-generating equipment.

Do not install the device in a place subject to high humidity, dust or soot.

Please keep the equipment installed horizontally or install the equipment in a stable place, taking care to prevent the product from falling.

Do not drop or spill liquid into the device and ensure that no liquid-filled items are placed on the device to prevent liquid from flowing into the device.

Install the device in a well-ventilated area, and do not block the ventilation openings of the device.

Use the device only within the rated input and output range.

Do not disassemble the device at will.

Please transport, use and store the device within the permissible humidity and temperature range.

### Power Requirement

Be sure to use the specified manufacturer's model battery, otherwise there is a danger of explosion!

Be sure to use the battery as required, otherwise there is a danger of the battery catching fire, exploding or burning!

Only use the same model of battery when replacing the battery!

Be sure to dispose of the used battery as the instruction of battery!

Be sure to use the power adapter that meets standard with the device, otherwise the personal injury or equipment damage caused by the user will be borne by the user.

Use a power supply that meets the SELV (Safety Extra Low Voltage) requirements and supply power according to the rated voltage of IEC60950-1 in accordance with the Limited Power Source. The specific power supply requirements are based on the equipment label.

Connect the Class I product to the power outlet with a protective ground connection.

The appliance is coupled to the port unit. Keep it at a proper angle for normal use.

## **Important Statement**

Users are required to enable and maintain the lawful interception (LI) interfaces of video surveillance products in strict compliance with relevant laws and regulations. Installation of surveillance devices in an office area by an enterprise or individual to monitor employee behavior and working efficiency outside the permitted scope of the local law and use of video surveillance devices for eavesdropping of illegal purposes constitute behaviors of unlawful interception.

This manual is only for reference and does not ensure that the information is totally consistent with the actual products. For consistency, see the actual products.

# Contents

## About This Document

### Contents

|   |    |
|---|----|
| <b>1 Preface</b> .....                            | 10 |
| 1.1 Product Description.....                      | 10 |
| 1.2 Product Features.....                         | 10 |
| 1.2.1 Cloud Upgrade.....                          | 10 |
| 1.2.2 Real-time Monitoring.....                   | 10 |
| 1.2.3 Playback.....                               | 10 |
| 1.2.4 User Management.....                        | 10 |
| 1.2.5 Storage Function.....                       | 10 |
| 1.2.6 Alarm Function.....                         | 11 |
| 1.2.7 Network Monitoring.....                     | 11 |
| 1.2.8 Split Screen 3.....                         | 11 |
| 1.2.9 Recording Function.....                     | 11 |
| 1.2.10 Backup Function.....                       | 11 |
| 1.2.11 External Device Control.....               | 11 |
| 1.2.12 Accessibility.....                         | 11 |
| <b>2 Product Structure</b> .....                  | 12 |
| 2.1 Front Panel.....                              | 12 |
| 2.2 Back Panel.....                               | 14 |
| 2.3 Important Notes.....                          | 20 |
| 2.4 About This User Manual.....                   | 20 |
| 2.5 Installation Environment and Precautions..... | 20 |
| <b>3 Install device</b> .....                     | 22 |
| 3.1 Process.....                                  | 22 |
| 3.2 Unpacking Inspection.....                     | 23 |
| 3.3 Install Hard Disk.....                        | 23 |
| 3.3.1 Install One or Two Hard disks.....          | 24 |
| 3.3.2 Install Four Hard disks.....                | 25 |
| 3.3.3 Install Eight Hard disks.....               | 25 |
| <b>4 Basic Operations</b> .....                   | 27 |
| 4.1 Power on the Device.....                      | 27 |
| 4.2 Activation.....                               | 28 |
| 4.3 Power off the Device.....                     | 32 |
| 4.4 Login to the System.....                      | 32 |
| <b>5 Wizard</b> .....                             | 34 |
| <b>6 Quick Navigation</b> .....                   | 40 |
| 6.1 Alarm message.....                            | 43 |
| 6.2 Real Time Video Bar.....                      | 44 |
| 6.3 Playback.....                                 | 46 |
| 6.3.1 Time Search.....                            | 48 |
| 6.3.2 Picture Grid.....                           | 49 |
| 6.3.3 Event Recording.....                        | 50 |
| 6.3.4 Backup.....                                 | 51 |
| 6.4 AI Recognition.....                           | 52 |
| 6.4.1 Real Time Comparison.....                   | 52 |
| 6.4.1.1 Human Face.....                           | 52 |
| 6.4.1.2 Vehicle License Plate.....                | 53 |
| 6.4.1.3 Vehicle and Full Body.....                | 53 |
| 6.4.1.4 Real-time Body Temperature Filter.....    | 54 |

|  |           |
|--|-----------|
| 6.4.2 Smart Search.....                    | 55        |
| 6.4.2.1 Human Face Search.....             | 55        |
| 6.4.2.2 Vehicle License Plate Search.....  | 58        |
| 6.4.2.3 Full Body Search.....              | 58        |
| 6.4.2.4 Vehicle Search.....                | 59        |
| 6.4.2.5 Body Temperature Search.....       | 60        |
| 6.4.2.6 Personnel Count.....               | 61        |
| 6.4.3 Archives Library.....                | 61        |
| 6.4.3.1 Face Library.....                  | 62        |
| 6.4.3.2 License Plate Library.....         | 63        |
| 6.4.4 Comparison Configuration.....        | 64        |
| 6.4.4.1 Face Comparison.....               | 64        |
| 6.4.4.2 License Comparison.....            | 65        |
| 6.4.4.3 Temperature Comparison.....        | 66        |
| 6.4.4.4 Mask Detection Configuration.....  | 67        |
| 6.4.4.5 Personnel Count Configuration..... | 68        |
| 6.5 Attendance.....                        | 69        |
| 6.5.1 Attendance Data.....                 | 69        |
| 6.5.2 Attendance Management.....           | 70        |
| 6.6 Thermal Temperature.....               | 73        |
| 6.6.1 Temperature Parameters.....          | 73        |
| 6.6.2 Temperature Area.....                | 76        |
| 6.6.3 Schedule Linkage.....                | 79        |
| 6.6.4 Advanced.....                        | 80        |
| 6.6.5 Inquire.....                         | 81        |
| 6.7 Channel Information.....               | 82        |
| 6.8 Main Menu.....                         | 82        |
| <b>7 UI System Setting.....</b>            | <b>83</b> |
| 7.1 Channel Management.....                | 83        |
| 7.1.1 Camera.....                          | 83        |
| 7.1.1.1 Add Camera Automatically.....      | 84        |
| 7.1.1.2 Add Camera Manually.....           | 84        |
| 7.1.1.3 Add Camera by RSTP.....            | 85        |
| 7.1.1.4 Delete Camera.....                 | 86        |
| 7.1.1.5 Operate Camera.....                | 86        |
| 7.1.2 Encode Parameter.....                | 87        |
| 7.1.3 Sensor Setting.....                  | 88        |
| 7.1.4 OSD Settings.....                    | 90        |
| 7.1.5 Privacy Zone.....                    | 90        |
| 7.1.6 ROI.....                             | 92        |
| 7.1.7 Microphone.....                      | 93        |
| 7.1.8 Human Thermometer .....              | 94        |
| 7.1.8.1 Parameter Configuration.....       | 94        |
| 7.1.8.2 Thermal Mapping.....               | 99        |
| 7.1.8.3 Thermal Calibration.....           | 100       |
| 7.1.9 Smart.....                           | 101       |
| 7.1.9.1 AI Multiobject.....                | 101       |
| 7.1.9.2 License Plate Recognition.....     | 104       |
| 7.1.9.3 Face Detection.....                | 105       |
| 7.1.10 Intelligent Tracking.....           | 107       |
| 7.2 Record Setting.....                    | 109       |
| 7.2.1 Record Schedule.....                 | 109       |
| 7.2.2 Disk.....                            | 110       |
| 7.2.3 RAID.....                            | 111       |
| 7.2.4 Storage Mode.....                    | 112       |
| 7.2.5 S.M.A.R.T.....                       | 113       |
| 7.2.5.1 S.M.A.R.T.....                     | 113       |

|                                 |     |
|---------------------------------|-----|
| 7.2.5.2 WDDA.....               | 113 |
| 7.2.6 Disk Detection.....       | 114 |
| 7.2.7 Cloud Storage.....        | 115 |
| 7.2.8 Disk Calculation.....     | 116 |
| 7.2.9 FTP.....                  | 117 |
| 7.3 Alarm Management.....       | 117 |
| 7.3.1 General.....              | 117 |
| 7.3.1.1 General.....            | 117 |
| 7.3.1.2 IO control push.....    | 119 |
| 7.3.2 Motion Detection.....     | 119 |
| 7.3.3 Video Loss.....           | 122 |
| 7.3.4 Intelligent Analysis..... | 123 |
| 7.3.5 Alarm In.....             | 126 |
| 7.3.6 Abnormal Alarm.....       | 127 |
| 7.3.7 Alarm Out.....            | 128 |
| 7.3.7.1 Alarm Out.....          | 128 |
| 7.3.7.2 Camera Alarm out.....   | 128 |
| 7.4 Network Management.....     | 130 |
| 7.4.1 Network.....              | 130 |
| 7.4.1.1 IP.....                 | 130 |
| 7.4.1.2 Port.....               | 130 |
| 7.4.1.3 IPv4CCTV.....           | 131 |
| 7.4.1.4 POE.....                | 132 |
| 7.4.1.5 WiFi Parameter.....     | 133 |
| 7.4.1.6 WiFi Network.....       | 134 |
| 7.4.2 802.1 X.....              | 134 |
| 7.4.3 DDNS.....                 | 135 |
| 7.4.4 Port Mapping.....         | 136 |
| 7.4.4.1 Port Mapping.....       | 136 |
| 7.4.4.2 NAT Port.....           | 137 |
| 7.4.5 E-mail.....               | 138 |
| 7.4.6 P2P.....                  | 140 |
| 7.4.7 IP Filter.....            | 141 |
| 7.4.8 SNMP.....                 | 142 |
| 7.4.9 3G/4G.....                | 143 |
| 7.4.10 PPPOE.....               | 144 |
| 7.4.11 POE Status .....         | 145 |
| 7.4.12 Network Traffic.....     | 145 |
| 7.5 System Management.....      | 145 |
| 7.5.1 Information.....          | 146 |
| 7.5.2 General.....              | 148 |
| 7.5.2.1 System.....             | 148 |
| 7.5.2.2 Date and Time.....      | 149 |
| 7.5.2.3 Time Zone .....         | 150 |
| 7.5.2.4 DST.....                | 151 |
| 7.5.2.5 Sync Camera Time.....   | 152 |
| 7.5.3 User Account.....         | 153 |
| 7.5.3.1 User.....               | 153 |
| 7.5.3.2 Advance Setting.....    | 155 |
| 7.5.3.3 Security Code.....      | 155 |
| 7.5.3.4 Password.....           | 156 |
| 7.5.3.5 Pattern Unlock.....     | 157 |
| 7.5.3.6 Secure Email.....       | 158 |
| 7.5.3.7 Secure Question.....    | 159 |
| 7.5.4 Layout.....               | 159 |
| 7.5.5 Auxliary Screen.....      | 162 |
| 7.5.6 Logs.....                 | 163 |

|  |            |
|--|------------|
| 7.5.6.1 System Log.....                        | 163        |
| 7.5.6.2 Event Log.....                         | 164        |
| 7.5.7 Maintenance.....                         | 165        |
| 7.5.8 Auto Reboot .....                        | 166        |
| <b>8 WEB Quick Start.....</b>                  | <b>168</b> |
| 8.1 Activation.....                            | 168        |
| 8.2 Login and Logout.....                      | 169        |
| 8.3 Browsing Videos.....                       | 172        |
| 8.3.1 Browsing Real-Time Videos.....           | 172        |
| 8.3.2 Live Video.....                          | 173        |
| 8.3.3 Channel Operation.....                   | 174        |
| 8.3.4 PTZ Control and Setting.....             | 175        |
| 8.3.5 Sensor Setting.....                      | 176        |
| 8.3.6 Layout.....                              | 178        |
| 8.4 Playback.....                              | 178        |
| 8.4.1 Video Playback.....                      | 178        |
| 8.5 Alarm Search.....                          | 180        |
| 8.5.1 Channel Alarm.....                       | 180        |
| 8.6 Attendance.....                            | 181        |
| 8.6.1 Attendance Data.....                     | 181        |
| 8.6.2 Attendance Management.....               | 182        |
| 8.7 AI Recognition.....                        | 185        |
| 8.7.1 Real Time Comparison.....                | 185        |
| 8.7.1.1 Human Face.....                        | 185        |
| 8.7.1.2 Vehicle License Plate.....             | 185        |
| 8.7.1.3 Vehicle and Full Body.....             | 186        |
| 8.7.1.4 Real Time Body Temperature Filter..... | 187        |
| 8.7.2 Smart Search.....                        | 187        |
| 8.7.2.1 Human Face Search.....                 | 187        |
| 8.7.2.2 Vehicle License Plate Search.....      | 188        |
| 8.7.2.3 Full Body Search.....                  | 188        |
| 8.7.2.4 Vehicle Search.....                    | 189        |
| 8.7.2.5 Body Temperature Search.....           | 189        |
| 8.7.2.6 Personnel Count.....                   | 190        |
| 8.7.3 Archives Library.....                    | 190        |
| 8.7.3.1 Face Library.....                      | 190        |
| 8.7.3.2 License Plate Library.....             | 191        |
| 8.7.4 Comparison Configuration.....            | 191        |
| <b>9 System Setting.....</b>                   | <b>195</b> |
| 9.1 Channel.....                               | 195        |
| 9.1.1 Camera.....                              | 195        |
| 9.1.1.1 Protocol Management.....               | 197        |
| 9.1.2 Encode.....                              | 198        |
| 9.1.3 Sensor Setting.....                      | 198        |
| 9.1.5 Privacy Zone.....                        | 200        |
| 9.1.6 ROI.....                                 | 201        |
| 9.1.7 Microphone.....                          | 202        |
| 9.1.8 Human Thermometer.....                   | 202        |
| 9.1.9 Smart.....                               | 202        |
| 9.1.10 Intelligent Tracking.....               | 203        |
| 9.2 Record.....                                | 203        |
| 9.2.1 Record Schedule.....                     | 203        |
| 9.2.2 Disk.....                                | 204        |
| 9.2.3 RAID.....                                | 205        |
| 9.2.4 S.M.A.R.T.....                           | 206        |
| 9.2.5 Disk Calculation.....                    | 207        |



|                                    |            |
|------------------------------------|------------|
| 9.2.6 Storage Mode.....            | 207        |
| 9.2.7 Cloud Storage.....           | 208        |
| 9.3 Alarm.....                     | 209        |
| 9.3.1 General.....                 | 209        |
| 9.3.1.1 General.....               | 209        |
| 9.3.1.2 IO Control Push.....       | 209        |
| 9.3.2 Motion Detection.....        | 210        |
| 9.3.3 Video Loss.....              | 211        |
| 9.3.4 Intelligent Analysis.....    | 212        |
| 9.3.5 Alarm In.....                | 213        |
| 9.3.6 Abnormal Alarm.....          | 213        |
| 9.3.7 Alarm out.....               | 214        |
| 9.4 Network.....                   | 215        |
| 9.4.1 Network.....                 | 215        |
| 9.4.2 DDNS.....                    | 216        |
| 9.4.3 E-mail.....                  | 217        |
| 9.4.4 Port Mapping.....            | 218        |
| 9.4.4.1 Port Mapping.....          | 218        |
| 9.4.4.2 NAT port.....              | 218        |
| 9.4.5 P2P.....                     | 219        |
| 9.4.6 IP Filter.....               | 220        |
| 9.4.7 802.1X.....                  | 221        |
| 9.4.8 SNMP.....                    | 221        |
| 9.4.9 Web Mode.....                | 223        |
| 9.4.10 3G/4G.....                  | 224        |
| 9.4.11 PPPOE.....                  | 224        |
| 9.4.12 POE Status .....            | 225        |
| 9.5 System.....                    | 226        |
| 9.5.1 Device Information.....      | 226        |
| 9.5.2 General.....                 | 228        |
| 9.5.3 User Account.....            | 231        |
| 9.5.3.1 Add User.....              | 231        |
| 9.5.3.2 Adv.Setting.....           | 232        |
| 9.5.4 Secutiy Code.....            | 233        |
| 9.5.5 Security Center.....         | 233        |
| 9.5.5.1 Password.....              | 233        |
| 9.5.5.2 Secure Email.....          | 234        |
| 9.5.5.3 Secure Question.....       | 234        |
| 9.5.6 Logs.....                    | 235        |
| 9.5.6.1 Logs.....                  | 235        |
| 9.5.6.2 Event.....                 | 235        |
| 9.5.7 Maintenance.....             | 236        |
| 9.5.8 Auto Reboot.....             | 237        |
| 9.6 Local.....                     | 237        |
| <b>10 Disk Compatibility .....</b> | <b>238</b> |

## 1. Preface

### 1.1 Product Description

This product is a high-performance NVR device. The product has local preview, video multi-screen split display, local real-time storage function of video files, support for mouse shortcut operation, remote management and control functions. This product supports three storage methods: central storage, front-end storage, and client storage. The front-end monitoring point can be located anywhere in the network without geographical restrictions. It is combined with other front-end devices such as network cameras, network video server networks, and professional video surveillance systems to form a powerful security monitoring network. In the networked deployment system of this product, the central point and the monitoring point need only one network cable to connect. It is not necessary to set up visual and audio lines to the monitoring point, and the construction is simple, and the wiring cost and maintenance cost are low. This product is widely used in public security, transportation, electric power, education and other industries.

### 1.2 Product Features

#### 1.2.1 Cloud Upgrade

For devices that have access to the public network, you can update the software of the device through online upgrade.

#### 1.2.2 Real-time Monitoring

It has a VGA (Video Graphics Array) port and an HDMI (High Definition Media Interface) port. It can be monitored by a monitor screen or monitor, and supports simultaneous output of VGA and HDMI.

#### 1.2.3 Playback

Each channel can independent real-time recording, and play functions such as retrieval, playback, network monitoring, video query, and download. Please refer to chapter Playback.

Multiple playback modes: slow release, fast release, reverse playback, and frame-by-frame playback.

The exact time when the event occurred can be displayed during playback of the recording. You can select any area of the screen for partial magnification.

#### 1.2.4 User Management

Each user group has a rights management set, which can be selected autonomously. The total rights set is a subset, and the user rights in the group cannot exceed the rights management set of the user group.

#### 1.2.5 Storage Function

According to the user's configuration and policies (such as through alarm and timing settings), the corresponding audio and video data transmitted by the remote device is stored in the NVR device. For details, please refer to chapter Storage Management.

Users can record by WEB mode as needed. The video files are stored on the computer where the client is located. Please refer to chapter Storage.

## 1.2.6 Alarm Function

Real-time response to external alarm input, correct processing according to the user's preset linkage settings and give corresponding prompts.

The setting options of the central alarm receiving server are provided, so that the alarm information can be actively and remotely notified, and the alarm input can come from various external devices connected.

The alarm information can be notified to the user by mail or APP push information.

## 1.2.7 Network Monitoring

Through the network, the audio and video data of the IP camera or NVS (Network Video Server) of the NVR device is transmitted to the network terminal for decompression and reproduction. The device supports 8 simultaneous online users to perform streaming operations. The audio and video data is transmitted using protocols such as HTTP (Hyper Text Transfer Protocol), TCP (Transmission Control Protocol), UDP (User Datagram Protocol), MULTICAST, RTP (Real-time Transport Protocol), and RTCP (Real Time Streaming Protocol). Use SNMP (Simple Network Management Protocol) for some alarm data or information. Support WEB mode access system, applied to WAN, LAN environment.

## 1.2.8 Split Screen

Image compression and digitization are used to compress several images in the same scale and display them on the display of a monitor. 1/4/8/9/16/32 screen splitting is supported during preview; 1/4/9/16 screen splitting is supported during playback.

## 1.2.9 Recording Function

The device supports regular recording, motion detection recording, alarm recording, and intelligent recording. The recording file is placed on the hard disk device, USB (Universal Serial Bus) device, and client PC (personal computer). It can be connected to the WEB terminal, USB device, or local device. Query and playback the stored video files.

## 1.2.10 Backup Function

Support USB2.0 and eSATA video backup.

## 1.2.11 External Device Control

The peripheral control function is supported, and the control protocol and connection interface of each peripheral can be freely set.

## 1.2.12 Accessibility

Supports video NTSC (Nation Television Standards Committee) system and PAL (Phase Alteration Line) system.

Supports system resource information and real-time display of running status.

Supports for logging recording.

Supports local GUI (Graphical User Interface) output and quick menu operation via mouse.

Supports playback of audio and video from remote IPC or NVS devices.



### **NOTE**

For other functions, please see the following text.

## 2. Product Structure

### 2.1 Front Panel

Figure 2-1 One disk/four disks model

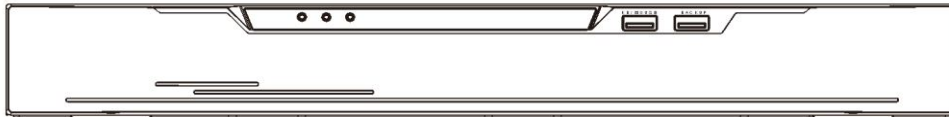


Table 2-1 Front panel function

| Port     | Description  |
|----------|--|
| PWR      | When the NVR is operating, the PWR indicator is steady on. When the NVR is shut down, the PWR indicator is turned off. |
| HDD      | Hard disk status indicator<br>This indicator flashes when data is transmitted.   |
| PoE      | PoE network status indicator<br>This indicator flashes when data is transmitted.                                       |
| KB/MOUSE | Only supports connected to an USB mouse.   |
| BACKUP   | Only supports connected to U disk  |

Figure 2-2 One disk model



Table 2-2 Front panel function


| Port  | Description  |
|---|--|
| PWR   | When the NVR is operating, the PWR indicator is steady on. When the NVR is shut down, the PWR indicator is turned off. |
| NET   | Network status indicator<br>This indicator flashes when data is transmitted.   |
| REC   | Hard disk status indicator<br>This indicator flashes when data is transmitted.   |
|  | Only supports connected to an USB mouse  |

Figure 2-3 One Eight disk model

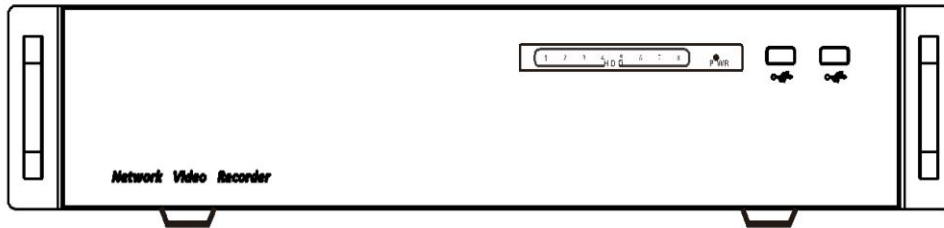


Table 2-3 Front panel function


| Port  | Description  |
|---|--|
| PWR   | When the NVR is operating, the PWR indicator is steady on. When the NVR is shut down, the PWR indicator is turned off. |
| HDD   | Hard disk status indicator<br>This indicator flashes when data is transmitted.   |
|  | Only supports connected to an USB mouse  |

Figure 2-4 WiFi model

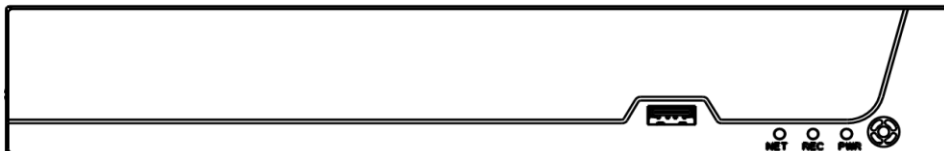



Table 2-4 Front panel function

| Port  | Description  |
|---|--|
| PWR   | When the NVR is operating, the PWR indicator is steady on. When the NVR is shut down, the PWR indicator is turned off. |
| NET   | Network status indicator<br>This indicator flashes when data is transmitted.   |
| REC   | Hard disk status indicator<br>This indicator flashes when data is transmitted.   |
|  | Only supports connected to an USB mouse  |

## 2.2 Back Panell

Figure 2-5 One Disk 4 PoE

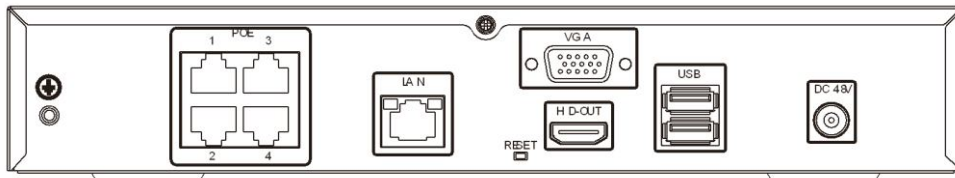


Figure 2-6 Two disks 8 PoE

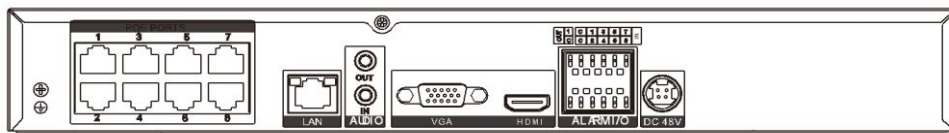


Table 2-5 Real panel function


| Port  | Description  |
|---|--|
| PoE   | PoE network interfaces                             |
| LAN   | RJ 45 10/100/1000 Mbps adaptive Ethernet interface |
| AUDIO OUT / AUDIO IN  | Audio output / Audio input                         |
| VGA   | Video output interface                             |
| HDMI  |  |
| Alarm I/O   | Alarm input/Alarm output                           |
|  | GND  |
| DC48V   | Connected to an external power adapter             |

Figure 2-7 One disk 8 PoE

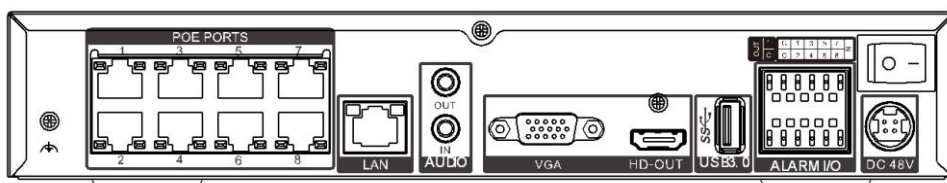


Table 2-6 Real panel function


| Port  | Description  |
|---|--|
| PoE   | PoE network interfaces                             |
| LAN   | RJ 45 10/100/1000 Mbps adaptive Ethernet interface |
| AUDIO OUT / AUDIO IN  | Audio output / Audio input                         |
| VGA   | Video output interface                             |
| HDMI  |  |
| USB 3.0   | Only supports connected to 3.0 U disk              |
| Alarm I/O   | Alarm input/Alarm output                           |
|  | GND  |
| DC48V   | Connected to an external power adapter             |

Figure 2-8 Four disks/ eight disks

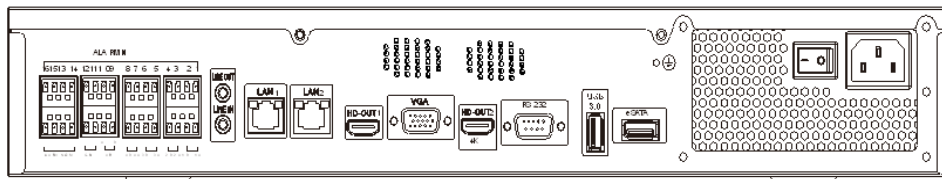


Table 2-7 Real panel function





| Port  | Description   |
|---|---|
|  | Alarm input and Alarm output./RS485                         |
| LINE OUT / LINE IN  | Audio output / Audio input                                  |
| LAN 1/LAN 2   | RJ 45 10/100/1000 Mbps adaptive Ethernet interface          |
| VGA   | Video output interface                                      |
| HDMI (1/2)  |   |
| RS 232  | Standard RS232 serial communication interface of the device |
| USB 3.0   | Only supports connected to 3.0 U disk                       |
| E SATA  | External hard disk interface                                |
|  | Power switch  |
|  | Safe ground screw of the device                             |
|  | AC 110V/220V power input interface                          |

Figure 2-9 Four disks 16 PoE

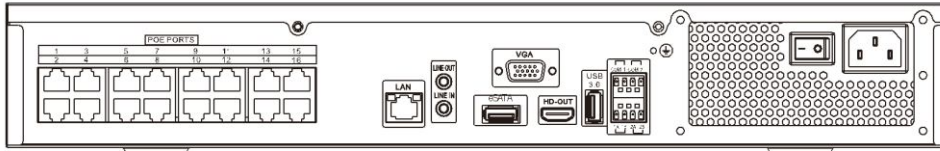


Table 2-8 Real panel function





| Port  | Description   |
|---|---|
| PoE port  | PoE network interfaces                                      |
|    | Alarm input and alarm output./RS485                         |
| LINE OUT /<br>LINE IN   | Audio output / Audio input                                  |
| LAN   | RJ 45 10/100/1000 Mbps adaptive Ethernet interface          |
| VGA   | Video output interface                                      |
| HDMI  |   |
| RS 232  | Standard RS232 serial communication interface of the device |
| USB 3.0   | Only supports connected to 3.0 U disk                       |
| E SATA  | External hard disk interface                                |
|  | Power switch  |
|  | Safe ground screw of the device                             |
|  | AC 110V/220V power input interface                          |

Figure 2-10 WiFi model

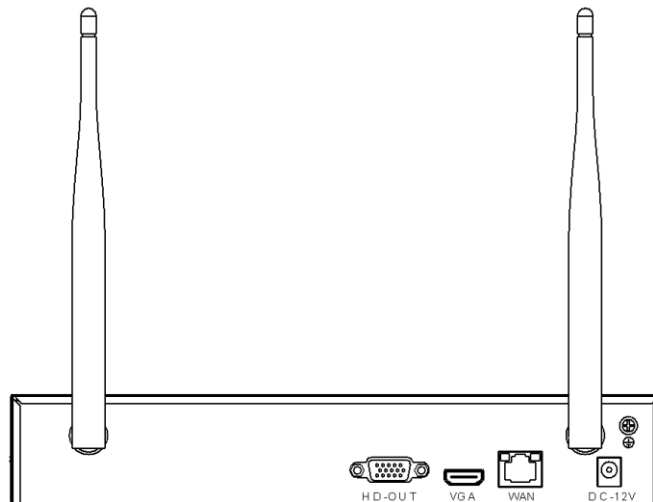
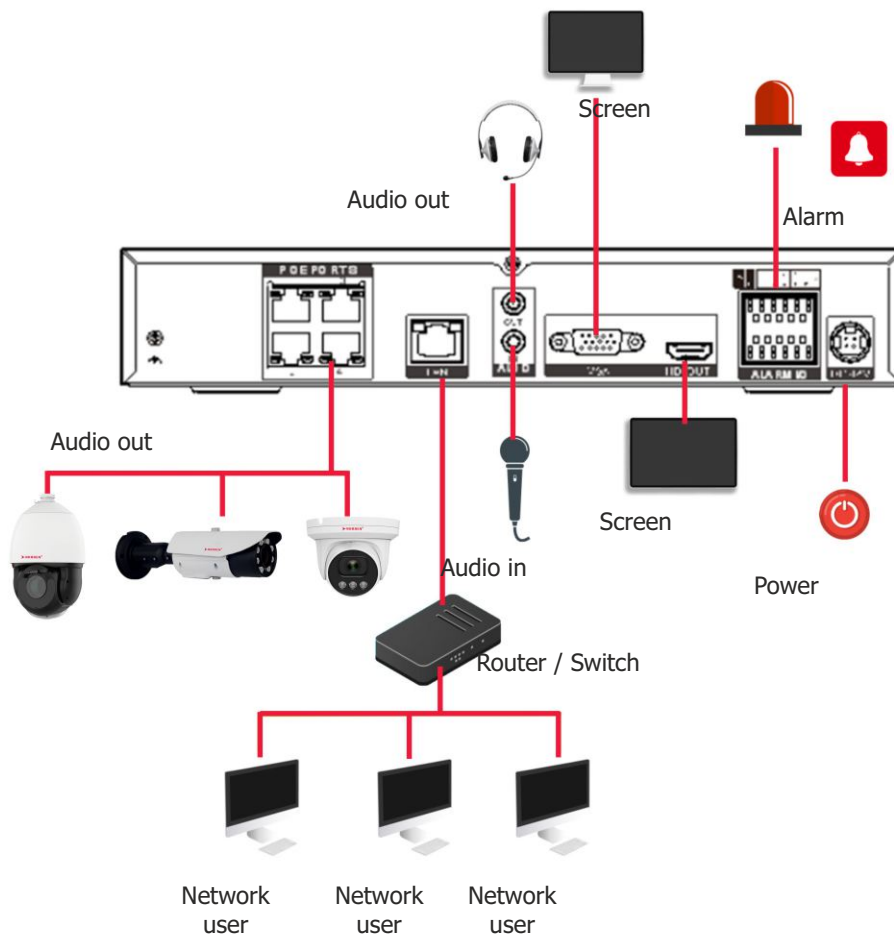
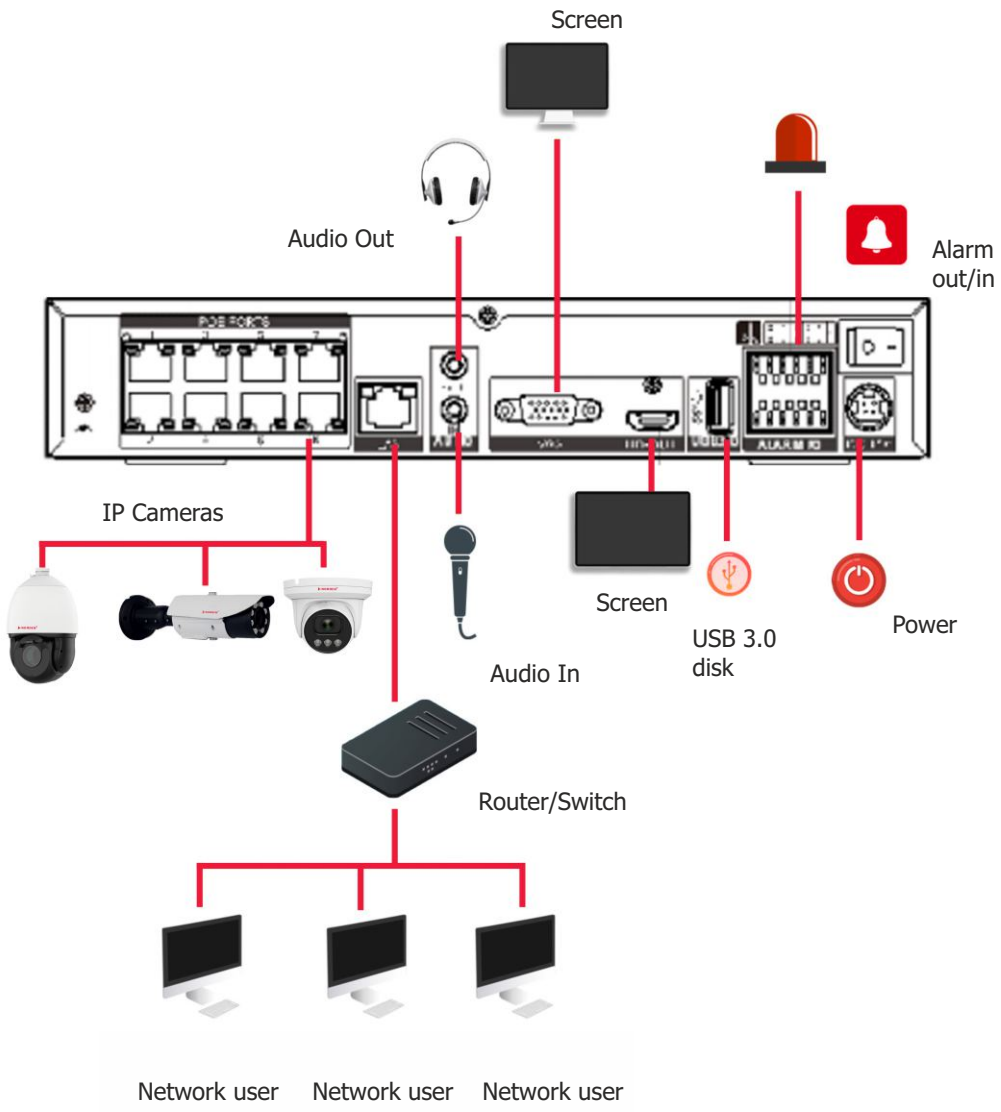


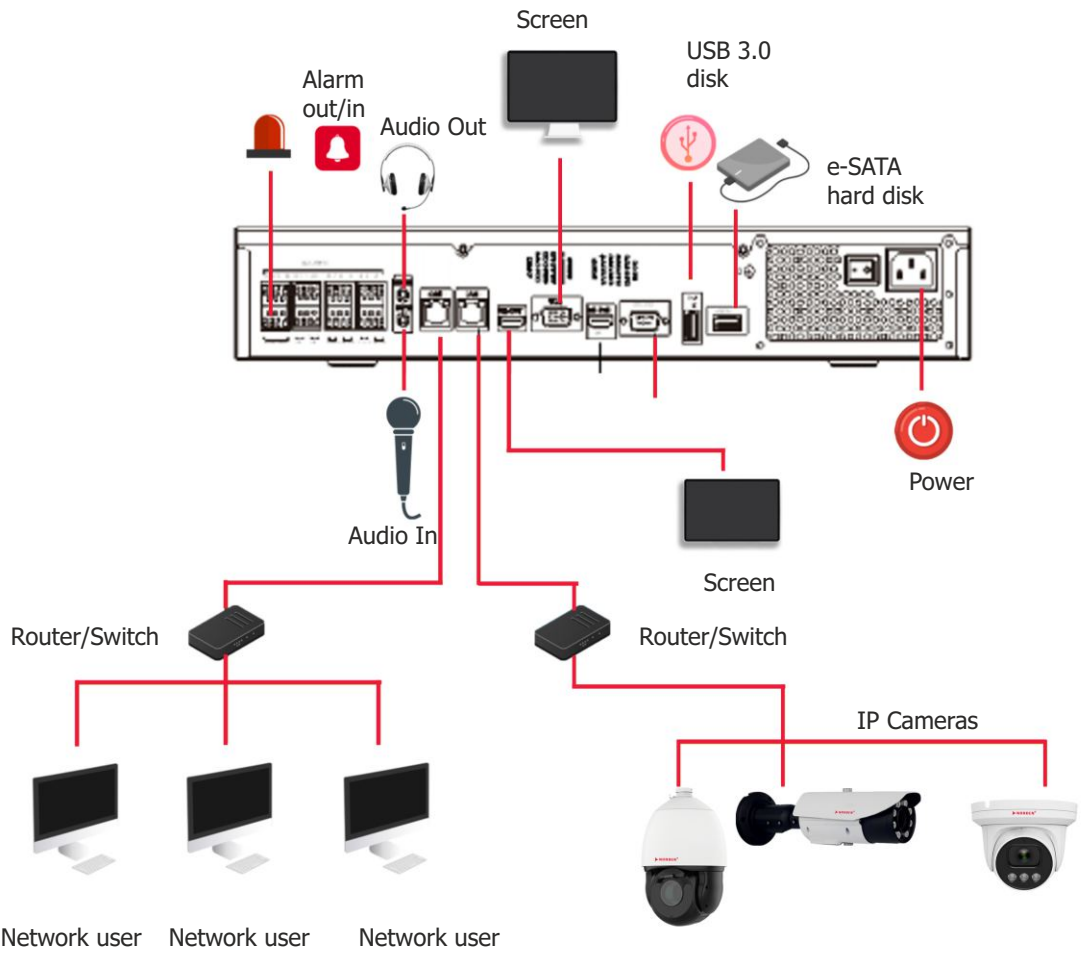


Table 2-9 Real panel function

| Port   | Description  |
|--------|--|
| WAN    | RJ 45 10/100/1000 Mbps adaptive Ethernet interface |
| VGA    | Video output interface                             |
| DC 12V | Connected to an external power adapter             |
|        | Safe ground screw of the device                    |







## 2.3 Important Notes

Thank you for choosing the NVR. Please read the user manual carefully before using this product.

The NVR is a complex system-based device. To avoid misoperations and malfunctions caused by environmental factors and human factors during installation, commission, and application, note the following points when installing and using this product:

Read the user manual carefully before installing and using this product

- Use Monitoring dedicated hard disks as the storage devices of the NVR with high stability and competitive price/performance ratios (the quality of hard disks sold on markets varies greatly with different brands and models).
- Do not open the enclosure of this product unless performed by a professional person to avoid damage and electric shock.
- We are not liable for any video data loss caused by improper installation, configuration, operation, and hard disk errors.
- All images in the document are for reference only, please subject to the actual products.

## 2.4 About This User Manual

Please note the following points before using this user manual:

- This user manual is intended for persons who operate and use the NVR.
- The information in this user manual applies to the full series NVR, NVR as an example for description.
- Read this user manual carefully before using the NVR and follow the methods described in this manual when using the NVR.
- If you have any doubts when using the NVR, contact your product seller.
- In the case of product upgrade, the information in this document is subject to change without notice.

## 2.5 Installation Environment and Precautions

### Installation environment

Table 2-10 defines the installation environment of the NVR.

Table 2-10 Installation Environment

| Item                 | Description   |
|----------------------|---|
| Electromagnetism     | The NVR conform to national standards of electromagnetic radiation and does not cause harm to the human body. |
| Temperature          | -10° C to +45° C  |
| Humidity             | 20% to 80%  |
| Atmospheric pressure | 86 Kpa to 106 Kpa   |
| Power supply         | DC 12V, DC 48V 2A(1 HDD) or AC110/220V 4A(2 HDDs or more), please refer to actual products Datasheet.         |
| Power consumption    | <15W (excluding the hard disk)  |

## Installation environment

Note the following points when installing and operating the NVR:

- The power adapter of the NVR uses DC48V  $\pm$  20% input. Do not use the NVR when voltage is too high or too low.
- Install the NVR horizontally.
- Avoid direct sunlight on the NVR and keep away from any heat sources and hot environments.
- Connect the NVR to other devices correctly during installation.
- The NVR is not configured with any hard disk upon delivery. Install one or more hard disks when using the NVR for the first time.
- 

The NVR identifies hard disk capacity automatically and supports mainstream hard disk models. User should use good brands of hard disk so that the NVR can operate stably and reliably, please refer to chapter 10 Disk Compatibility

## Other precautions

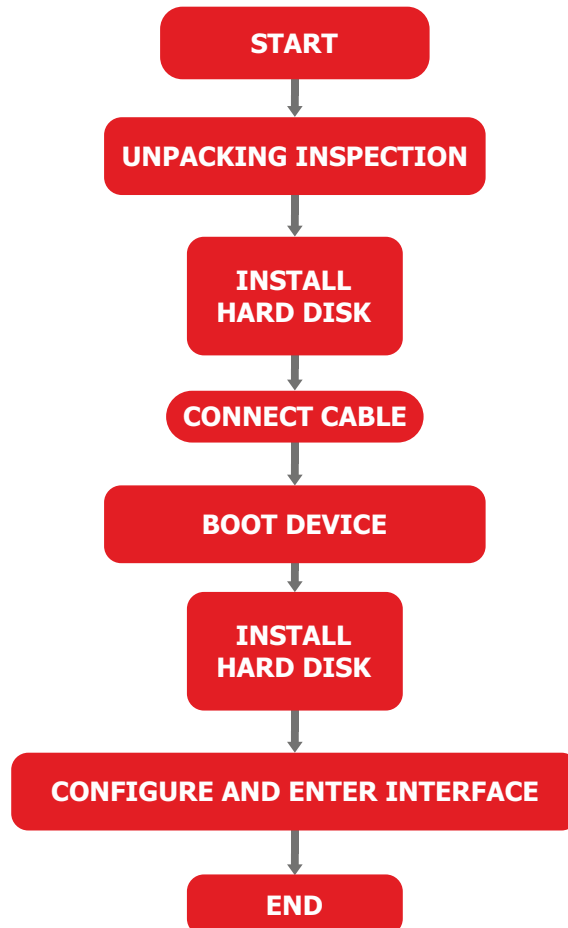
- Clean the NVR with a piece of soft and dry cloth. Do not use chemical solvents.
- Do not place objects on the NVR.  
The NVR meets the national standards of electromagnetic radiation and does not cause electromagnetic radiation to the human body.

## Series of NVR

- ENR-XXXXY-N-ZZZ
- XX-Number of Bay
- YYY-Number of Channel
- ZZZ-Available features

## 3.Install Device

### 3.1 Process





Please note the following points before using this user manual:

- Step 1 Check the appearance, packaging, and label of the device to ensure which no damage.
- Step 2 Install the hard disk and fix the hard disk on the device bracket.
- Step 3 Connect the device cable.
- Step 4 After ensuring that the device is connecting correct, connect the power and turn on the device.
- Step 5 Configure the initial parameters of the device. The boot wizard contains network configuration, add cameras, and manage disks. For details, please refer to the chapter of Wizard .

### 3.2 Unpacking Inspection

When the transportation company sends network video recorder to you, please check the following table for unpacking. If you have any questions, please contact our sales technicians.

Table 3-1 Unpacking Inspection

| No | Item              |  | Check content   |
|----|-------------------|--|---|
| 1  | Overall packaging | Appearance   | Is there any obvious damage   |
|    |                   | Package  | Is there accidental impact  |
|    |                   | Accessories  | Is it complete  |
| 2  | Label             | Label of device  | Is the equipment model consistent with the order contract? Whether the label is torn<br> <b>NOTE</b><br>Do not tear or discard, otherwise warranty service is not guaranteed. When you call the company for sales personnel calls, you will need to provide the serial number of the product on the label. |
| 3  | Cabinet           | Package  | Is there any obvious damage   |
|    |                   | Data cable, power cable, fan power supply, and motherboard | Is the connection loose?<br> <b>NOTE</b><br>If it is loose, please contact the company's after-sales personnel.  |

### 3.2 Install Hard Disk

When installing for the first time, first check if the hard disk is installed. It is recommended to use the company recommended hard disk model 10 disk compatibility. It is not recommended to use a PC dedicated hard disk.



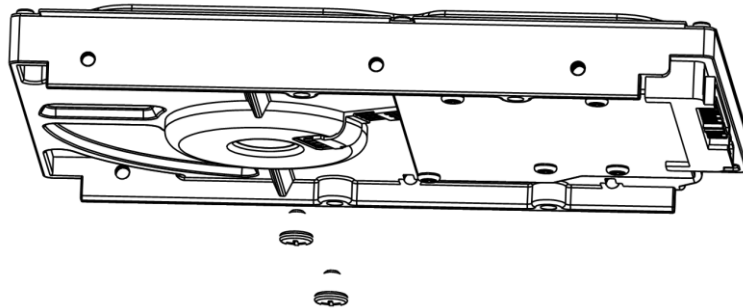
When replacing the hard disk, please turn off the power and then open the device to replace the hard disk. Please use the monitoring dedicated SATA hard disk recommended by the hard disk manufacturer. Use a reasonable hard disk capacity according to the recording requirements.

---

### 3.3.1 Install One or Two Hard disks

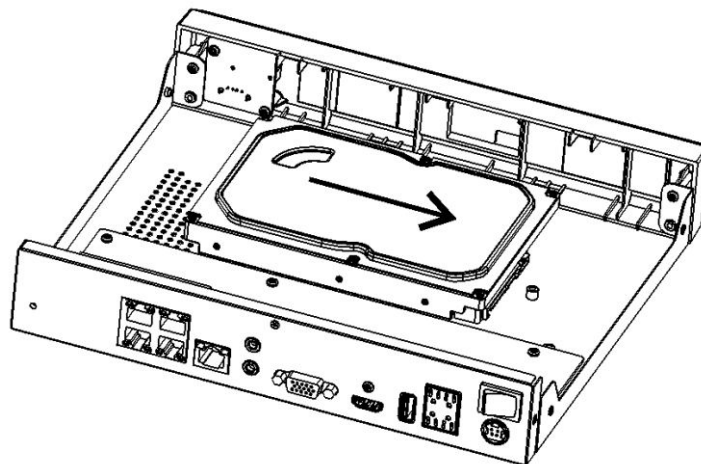
- Step 1 Remove the screws for fixing the upper cover and take down the cover.
- Step 2 Take out the screws and silicone cushion, route the screws through the silicone cushion, and install it to the screw holes, as show in .. Figure 3-1..

Figure 3-1 Installing the hard disk screws



- Step 3 Route the screws through the hole on the base, push the hard disk to the appropriate position on the left, as shown in Figure 3-2.

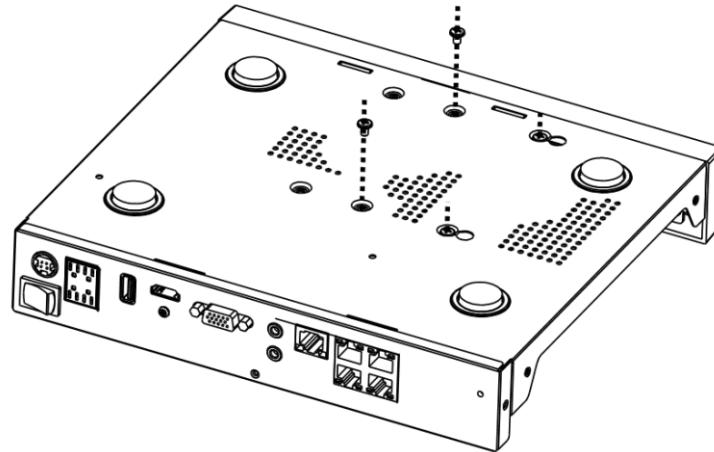
Figure 3-2 Install Hard disk



- Step 4 Turn the device over, and fasten the rest two hard disk fixing screws, as shown in Figure 3-3.



Figure 3-3 Install Hard disk



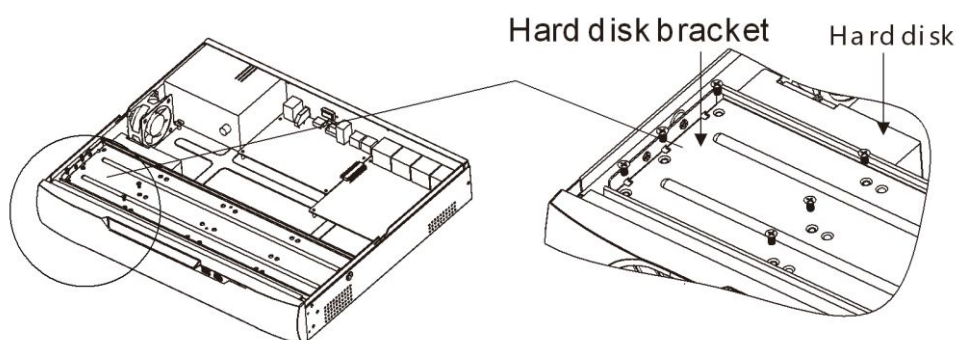
Step 5 Insert the hard disk data cable and power cable, then put on the upper cover and fasten the fixing screws.

### 3.3.2 Install Four Hard disks

Step 1 Remove the screws for fixing the upper cover and take down the cover.

Step 2 Put the hard disk under the hard disk bracket, hold the hard disk with one hand and aim the hard disk hole at the bracket hole, then fix the screws for hard disk (install the hard disk near the fan first), as shown in Figure 3-4

Figure 3-4 Installing the hard disks



Step 3 Install other hard disks following step 2.

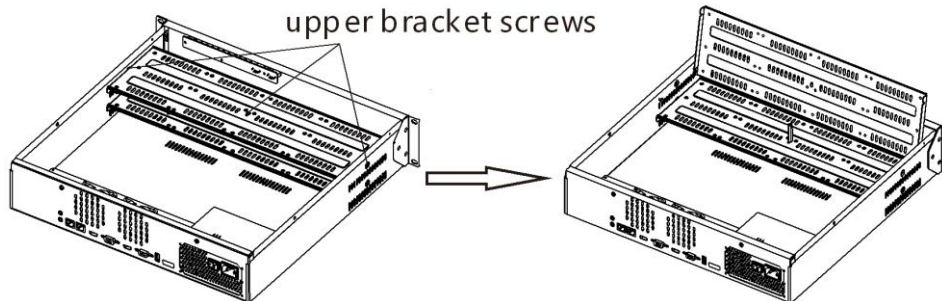
Step 4 Insert the hard disk data cable and power cable, then put on the upper cover and fasten the fixing screws.

### 3.3.3 Install Eight Hard disks

Step 1 Remove the screws for fixing the upper cover and take down the cover.

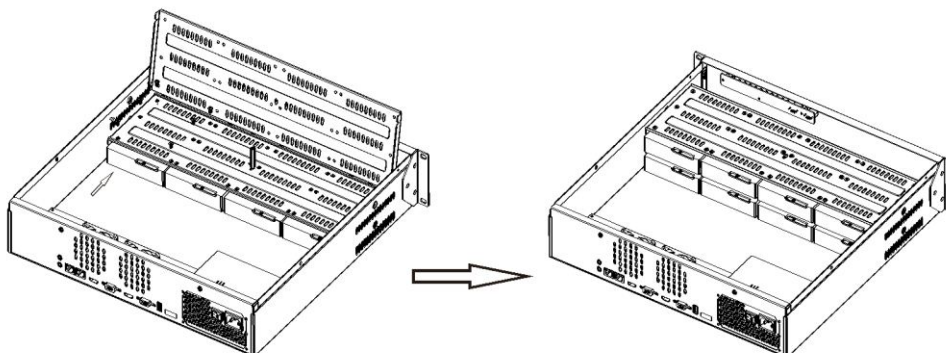
Step 2 Unscrew the screws on both sides and the upside of the upper bracket respectively, lift the upper bracket, as shown

Figure 3-5 Unscrew the screws lift the upper bracket



- Step 3 Put the hard disk under the lower bracket, hold the hard disk with one hand and aim the hard disk hole at the bracket hole, then fix the screws for hard disk, as shown in Figure 6
- Step 4 Pull down upper bracket and screw it, then install other hard disks in upper layer following step 3, as shown in the right figure in Figure 6

Figure 3-6 Unscrew the screws lift the upper bracket



- Step 5 Insert the hard disk data cable and power cable, then put on the upper cover and fasten the fixing screws.

## 4. Basic Operations

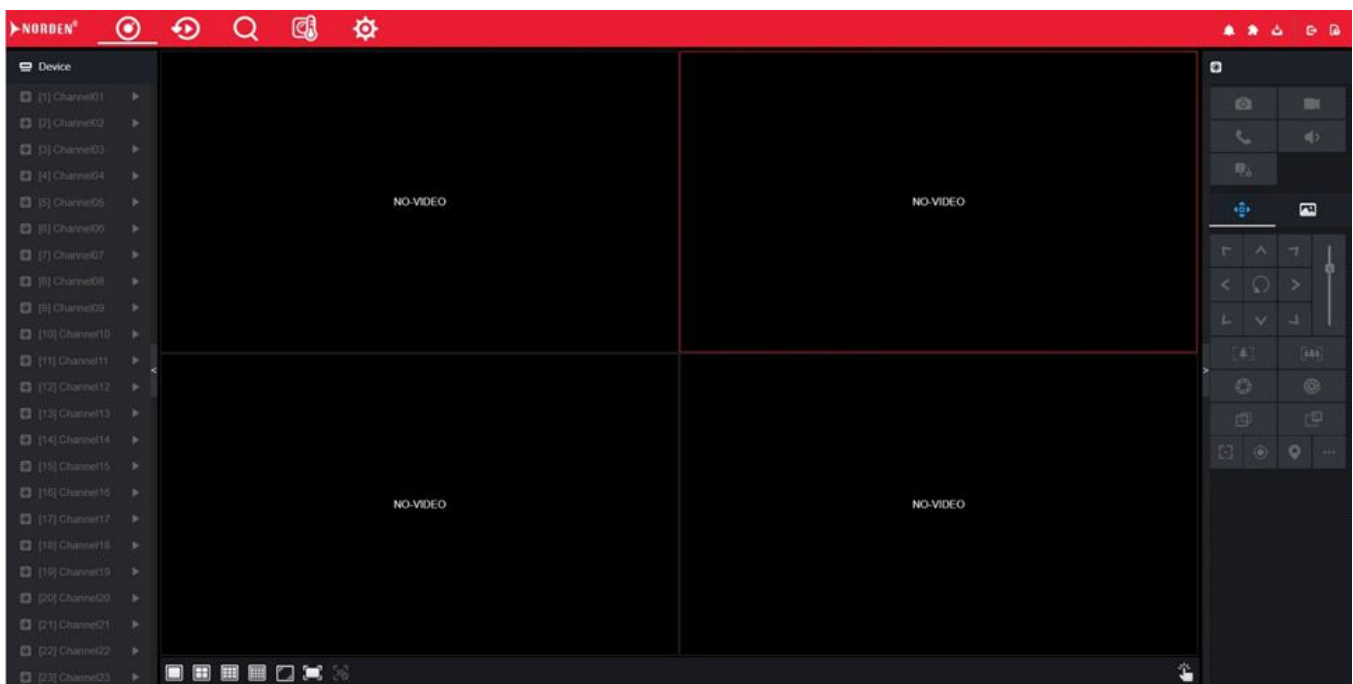
### 4.1 Power on the Device

#### CAUTION

- Ensure that the NVR is correctly connected to a power supply, and a display is correctly connected to the high-definition multimedia interface (HDMI) or video graphics array (VGA) port of the NVR before power-on.
- In some environments, abnormal power supply may cause the failure of the NVR to work properly and even damage the NVR in severe cases. It is recommended to use a regulated power supply to power the NVR in such environments.

After the NVR is connected to a power supply, the power indicator is steadily on. Start the NVR. The real-time video screen is displayed as shown in Figure 4-1.

Figure 4-1 Real-time video screen



#### NOTE

Users need to provide a hard disk for the NVR. The hard disk is strictly detected during device startup. If the detection result failed, the possible causes are as follows.

The hard disk is new and is not formatted. Login to the system and format the hard disk.

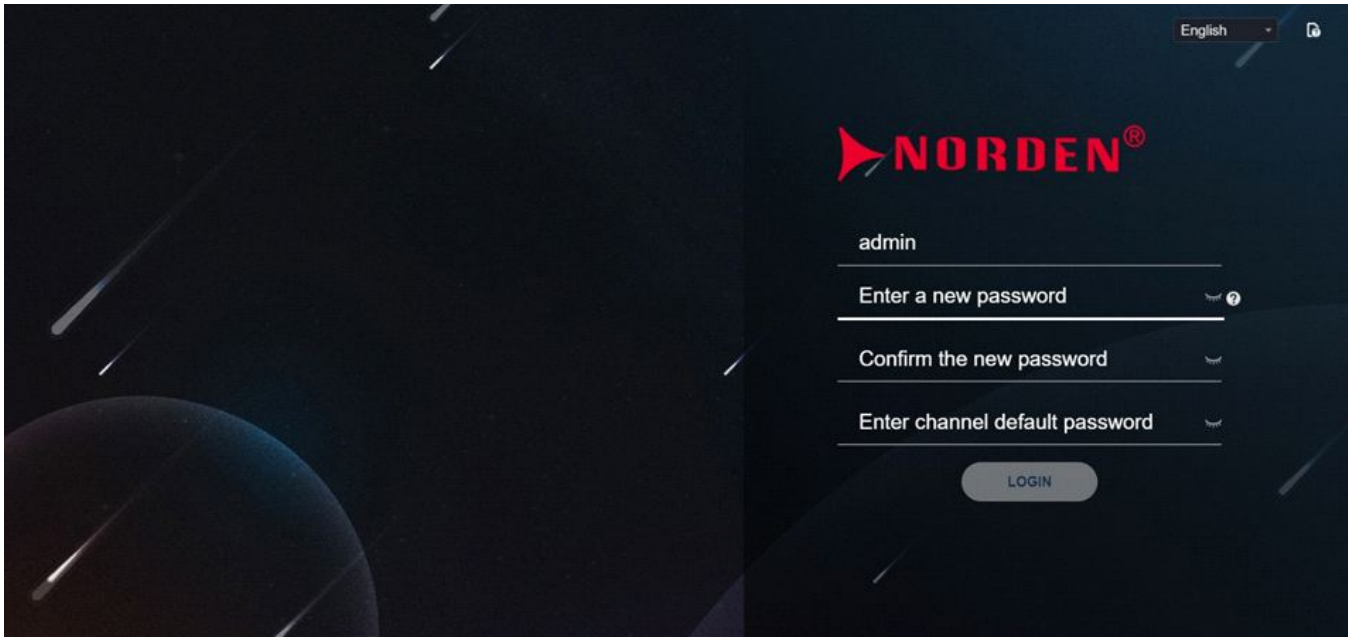
The hard disk is formatted, but the file system is inconsistent with the file system supported by the NVR. Format the hard disk.

The hard disk is damaged.

## 4.2 Activation

When the user login the device at first time, or reset the NVR, you need to activate the device and set login and channel default password, as shown in .

Figure 4-2 Activation



### Step 1 Description of Activation

| Name             | Description   |
|------------------|---|
| Username         | The default username is admin, and "admin" is super administrator.  |
| Password         | Valid password range 6-32 characters.<br>At least 2 kinds of numbers, lower case, upper case or special characters contained.<br>Only these special characters are supported!@#&*+=-~%&"'`(),/':.< >?^ ~[]{}. |
| Confirm password |   |
| Channel password | The NVR channel connection password is the camera login password.   |

User can set the pattern unlock to login the device, as shown in Figure 4-3

Figure 4-3 Set pattern unlock

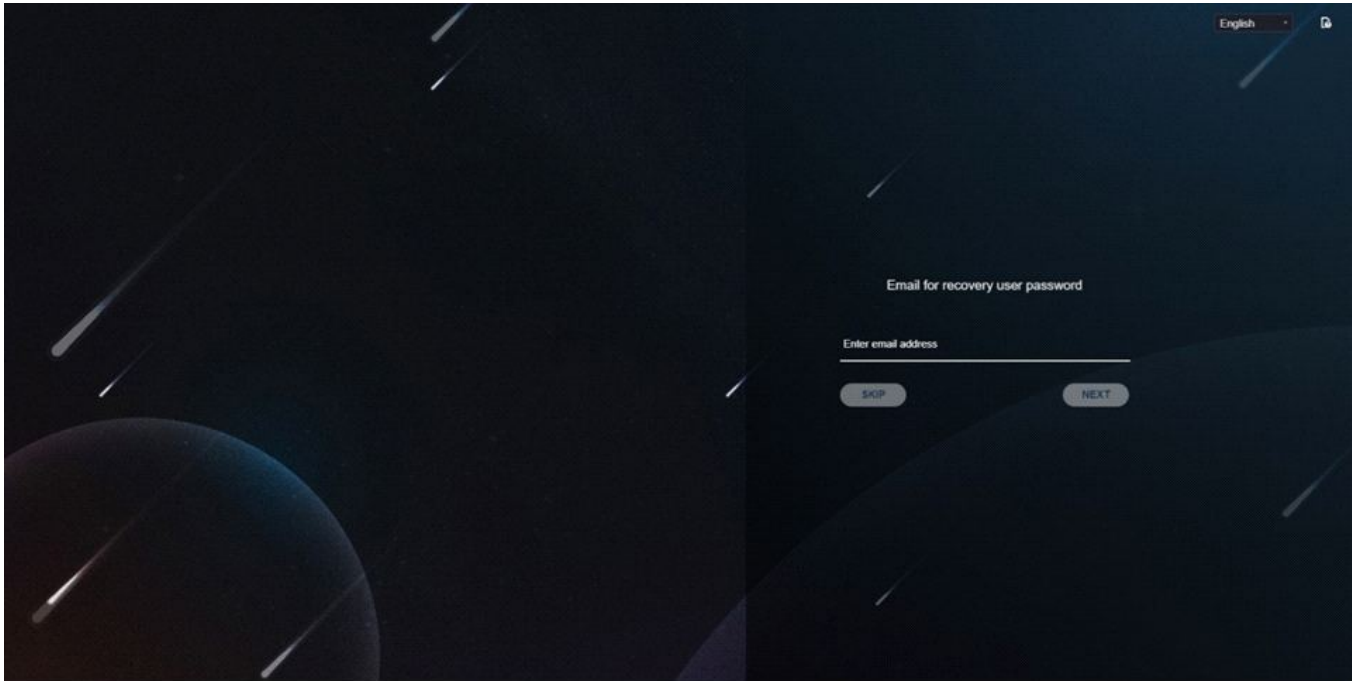


 **NOTE**

After the pattern is unlocked, the system defaults to the pattern unlock login. If the pattern unlock is not set, you will need to input the password to login. If you don't need to set the pattern to unlock, click "Skip this step".

Set the Email to receive the verification code if user forget the initial password to create new password, as shown in Figure 4-4.

Figure 4-4 Set Email

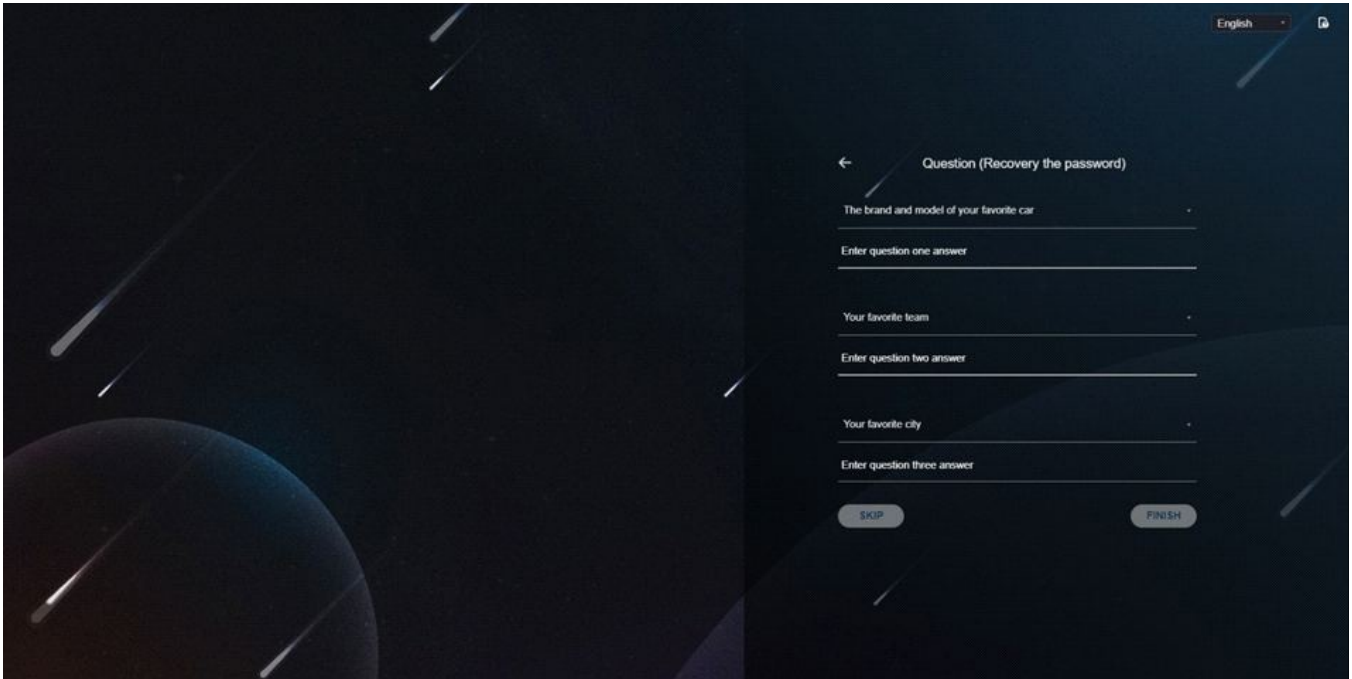


 **NOTE**

Set the email address, if you forget the password, you can through the email address to receive the verification, and reset the password. If the email address is not set, you can reply to the secure question or send the QR code to the seller to give the temporary password to login to the device. If you don't need to set the email, click "Skip this step".

Set the secure question, if user forgot the password can through the secure questions to create new password to login the device.

Figure 4-5 Set Question



 **NOTE**

The user can set three questions, and if they forget the password, they can answer the question and enter the reset password interface.

- Question one can be set: Your favorite animal
- Company name of your first job
- The name of the first boy/girl you like
- The worst security question you have ever seen
- The most funning/worst design you have ever seen
- Your favorite team
- Your favorite city

The three question options cannot be set to the same issue.  
 The answer requires a minimum of four characters and a maximum of 32 characters.  
 If you do not want to set a password question, you can click Skip this step.

### 4.3 Power off the Device

Click the main menu and choose **System > Maintenance**, the maintenance setting page is displaying, click **Shutdown** to power off the NVR. If there is a power switch on the rear panel of the NVR, you can RPM off the power switch to disconnect the NVR from the power supply.

### 4.4 Login to the System

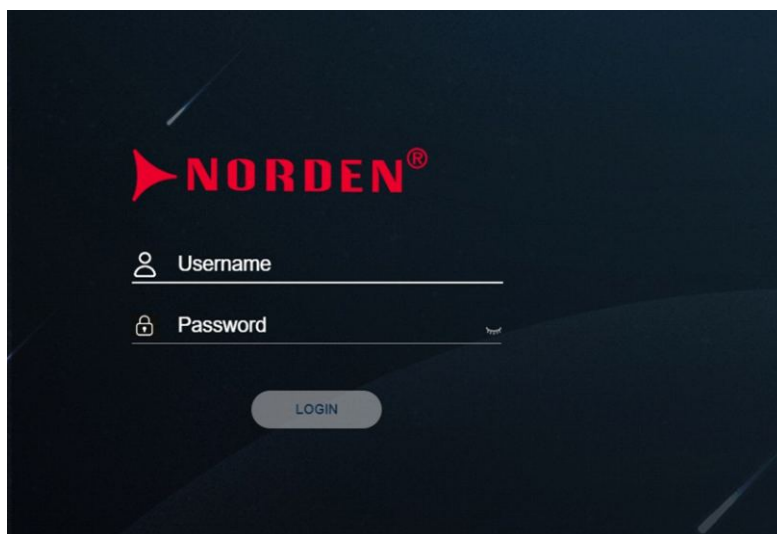
Step 1 Login to the device, there are two modes to login if you set the pattern unlock, as shown in Figure 4-6

Figure 4-6 Pattern unlock login page



On the NVR login page, click “Password” to at pattern unlock interface. If user don’ t set the pattern unlock it will show password to login interface directly, select the language, as shown in Figure 4-7

Figure 4-7 Password login page





Step 2 Input the username and password.

 **NOTE**

The password incorrect more than 3 times, please login again after 5 minutes. You can also power off, and power on to start on the device, input the correct password to avoid waiting five minutes. If user forget password, click Forgot password. User can choose a way to create new password:

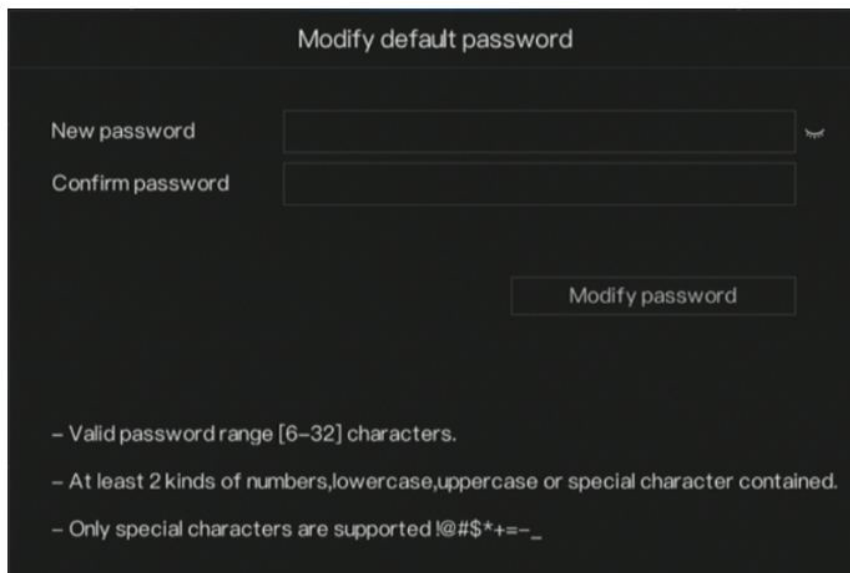
1. Scan the QR code and send the QR code to your seller, seller send the verification code to user and set new password to login .
2. Answer the secure question to create new password.

Click the main menu and choose **System > Maintenance**, the maintenance setting page is displaying, click **Shutdown** to power off the NVR. If there is a power switch on the rear panel of the NVR, you can RPM off the power switch to disconnect the NVR from the power supply.

Step 4 Click Login to access the main User Interface (UI).

Step 5 Modify the default password, as shown in Figure 4-8

Figure 4-8 Password login page



Modify default password

New password

Confirm password

Modify password

- Valid password range [6-32] characters.
- At least 2 kinds of numbers, lowercase, uppercase or special character contained.
- Only special characters are supported !@#\$\*+ = - \_

## 5. Wizard

Login the NVR, the wizard is showing on live video, click **Start Wizard**, the pop-up window will show as Figure 5-1

Figure 5-1 Wizard

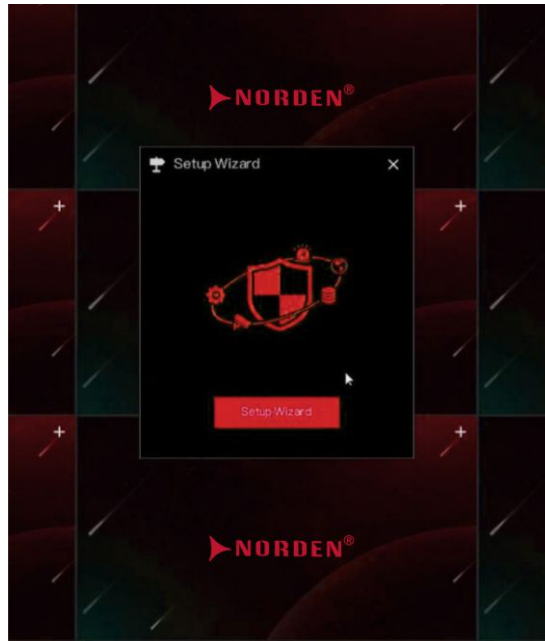
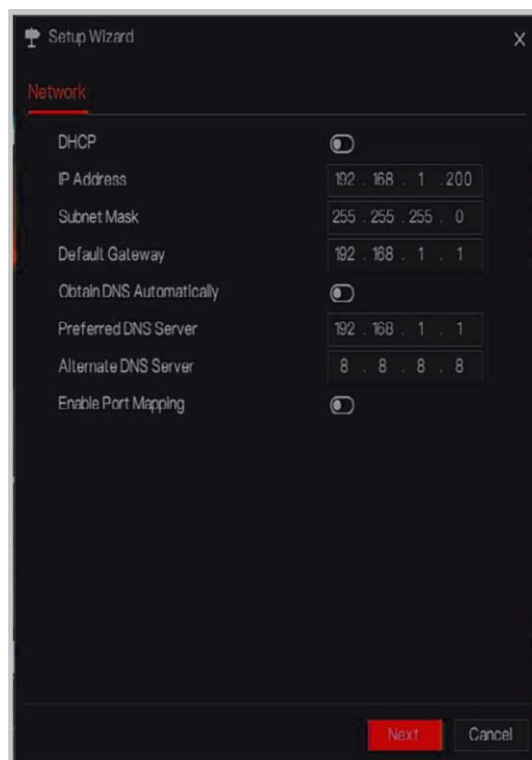


Figure 5-2 Wizard of network



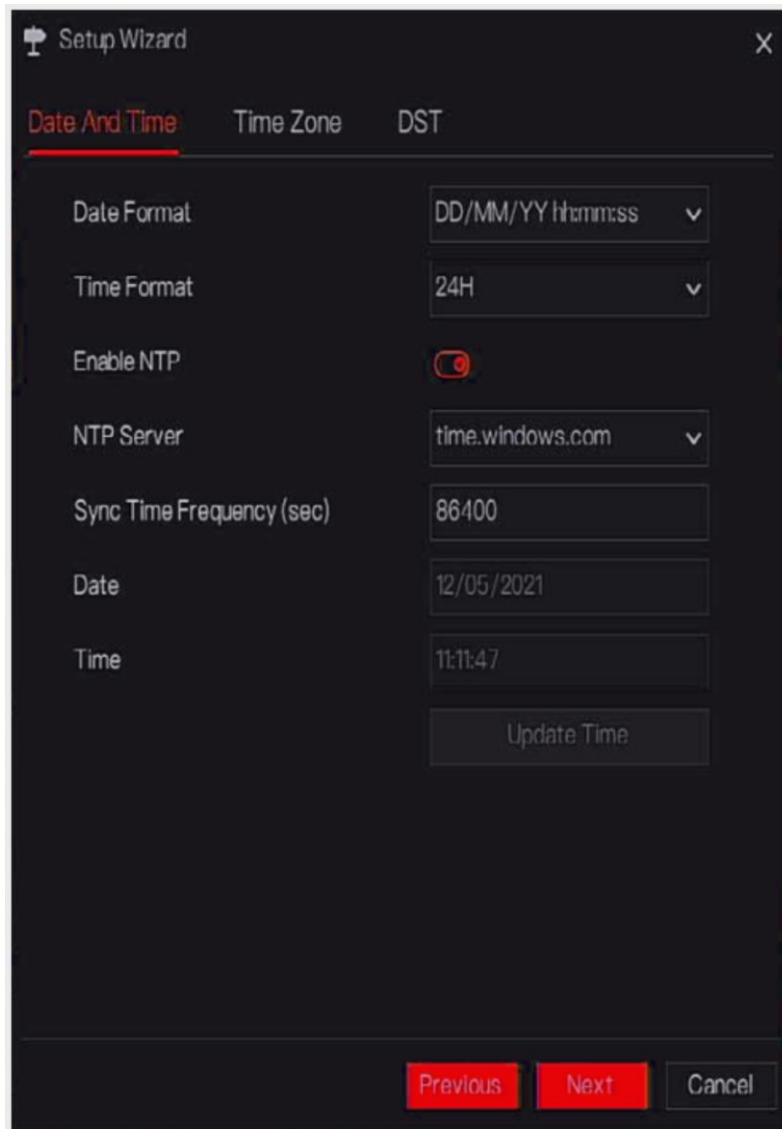
Step 1 Set the parameter, the details please refer to Table 5-1

Table -1 Network parameter

| Parameter                | Description  | Configuration  |
|--------------------------|--|--|
| DHCP                     | Enable DHCP, the device will obtain the IP address from the DHCP server.   | [Setting method]<br>Enable   |
| IP Address               | Set the IP of device when DHCP is disable  | [Setting method]<br>Manual   |
| Subnet mask              | Set the subnet mask of device  | [Setting method]<br>Manual<br><br>[Default value]<br>255.255.255.0             |
| Gateway                  | If the user wants to access device, he must set that   | [Setting method]<br>Manual<br><br>[Default value]<br>192.168.1.200             |
| Obtain DNS automatically | N/A  | [Setting method]<br>Enable   |
| Preferred DNS Server     | N/A  | [Setting method]<br>Manual<br>[Default value]<br>192.168.1.1                   |
| Alternate DNS Server     | N/A  | [Setting method]<br>Manual<br>[Default value]<br>8.8.8.8                       |
| Enable Port Mapping      | Enable to set the ports of HTTP, HTTPS, RSTP, Control.<br>Auto: device to obtain Web port, data port and client port.<br>Manual: user set the port manually. | [Setting method]<br>Choose type from drop-down list<br>[Default value]<br>Auto |
| Web Port                 | N/A  | [Setting method]<br>When UPnP is manual, you need to set these.                |
| Data Port                | N/A  |  |
| Client                   | N/A  |  |

Step 4 Click **Next** to view the basic information about device, as shown in Figure 5-3.

Figure 5-3 Wizard of Date and time



Choose date format and time format from drop-down list.

Click  to synchrony time from network.

Disable the NTP-Sync, set time manually.

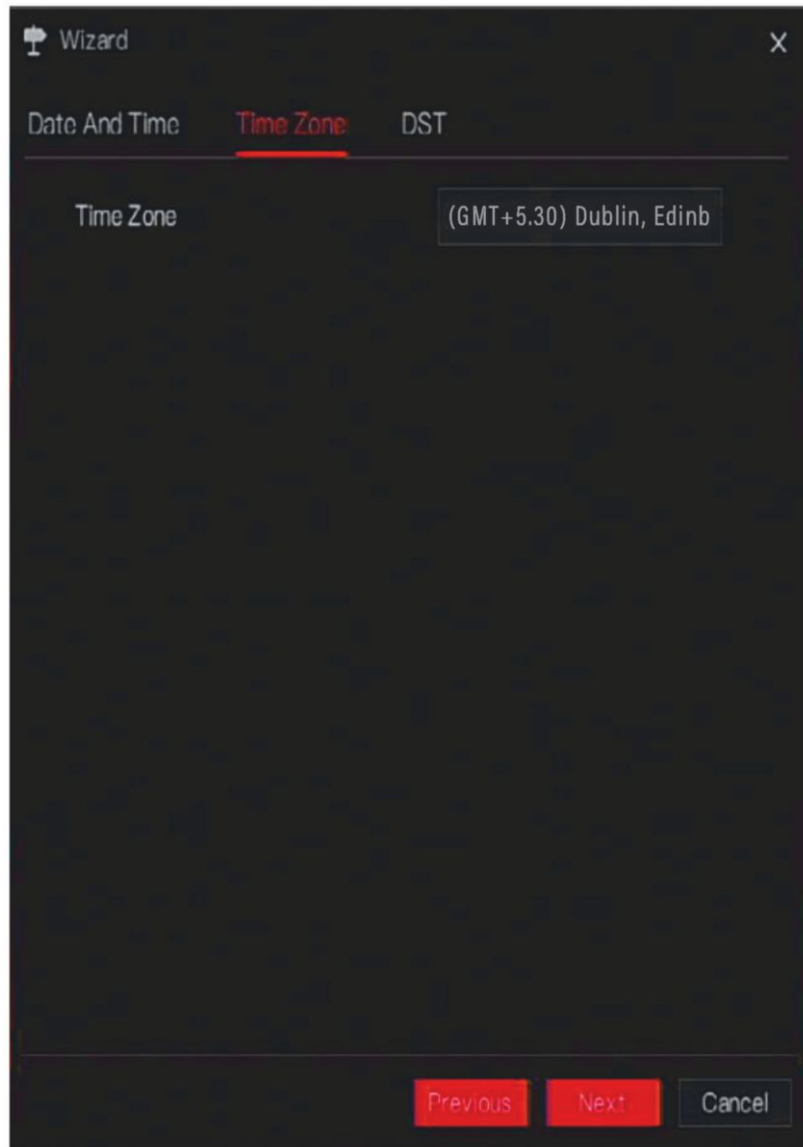
Roll the mouse to choose year, month and day when clicking the date.

Roll the mouse to choose hour, minute and second when clicking the date.

Click **Modify Time** to save the time.

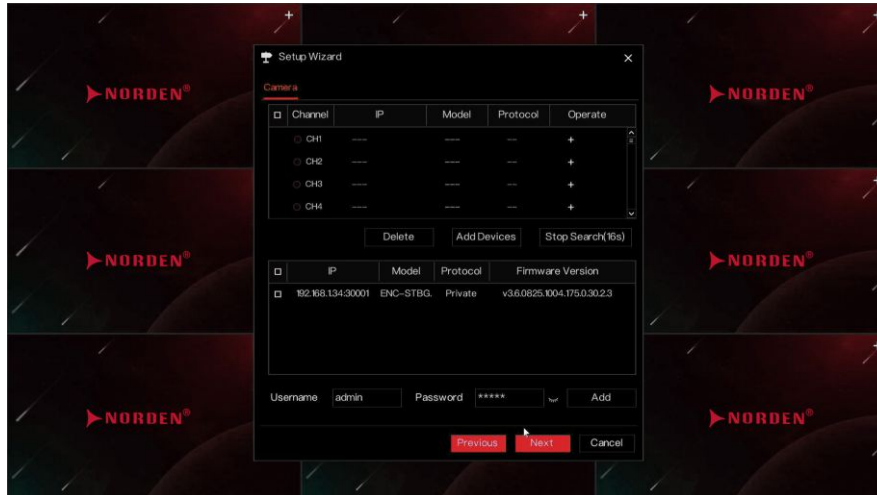
Step 3 Click **Time Zone**, choose the current time zone from drop-down list, as shown in . Figure 5-4

Figure 5-4 Wizard of Date and time



- Step 4 Click DST, enable the DST, set start and end time. Select offset time from drop-down list.
- Step 5 Click **Next** to enter the adding camera wizard, as shown in Figure 5-5.

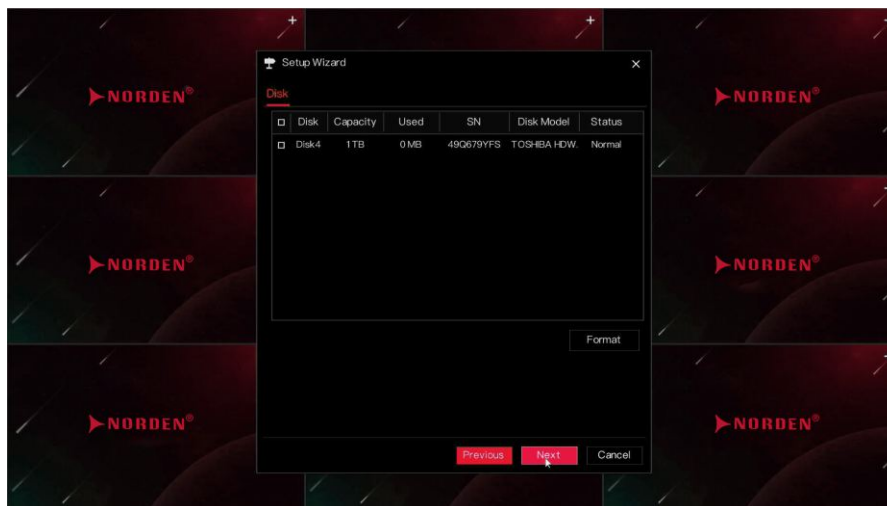
Figure 5-5 Wizard of adding camera



The details of adding camera please refer to chapter 7.1

Step 6 Click **Next** to enter wizard of the disk, as shown in Figure 5-6

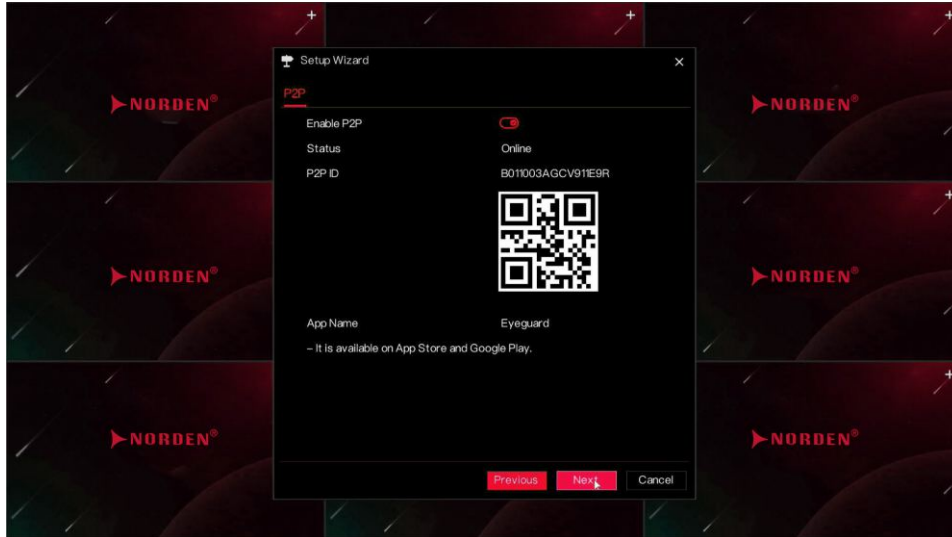
Figure 5-6 Wizard of disk



You can view the general information of disk. You can also format the disk.

Step 7 Click **Next** to enter enter wizard of P2P, as shown in Figure 5-7

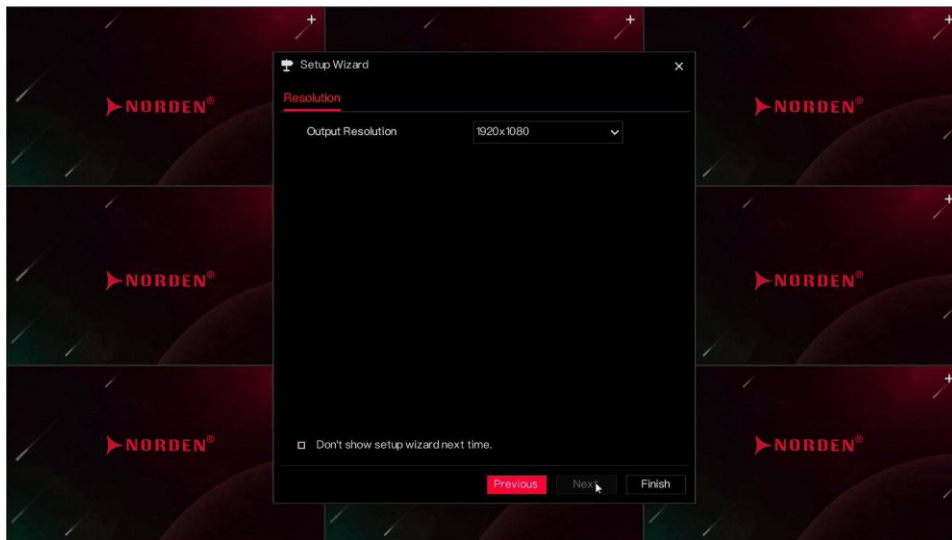
Figure 5-7 P2P



Step 8 Enable the P2P, user can use mobile devices to manage the NVR by scanning the P2P ID, if the mobile phone has loaded the InView Pro 4(search the APP at App Store or Google Play).

Step 9 Click **Next** to enter wizard of resolution, as shown in Figure 5-8 Choose resolution from drop-down list. (the highest resolution is 3840\*2160)

Figure 5-8 Wizard of resolution



Step 10 Click **Finish** to end the wizard, tick the **Not show this window next time**, wizard would not show at next time. Reopen wizard at **system >user >advance setting**.

## 6.Quick Navigation

After the NVR operation screen is displaying, move the cursor to the down most position of the NVR screen. The NVR floating menu bar is displaying.


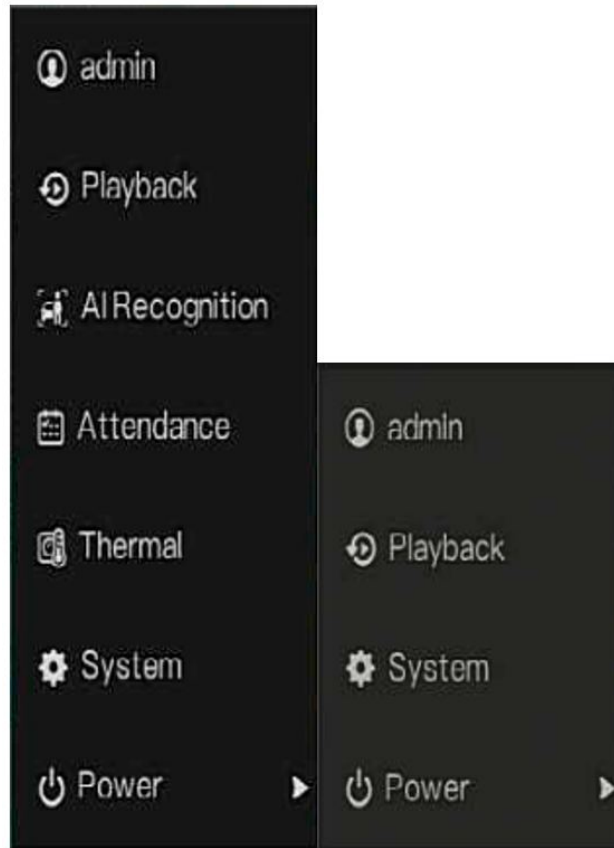
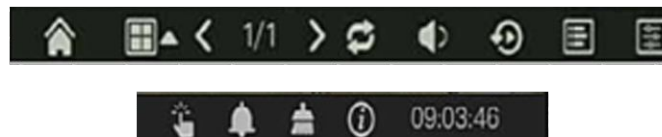
Click  in the left of NVR floating menu bar. The quick home menu is showing. The quick home menu provides **Playback, System and Power (Shutdown, Reboot and Logout)** as shown in Figure 6-1

Figure 6-1 Quick home menu



In the middle of NVR floating menu bar, the video tool bar provides **video window switching, auto SEQ, volume, playback, and channel information**, as shown in .Figure 6-2.

Figure 6-2 Real time video toolbar



The real-time video toolbar is described as follows:






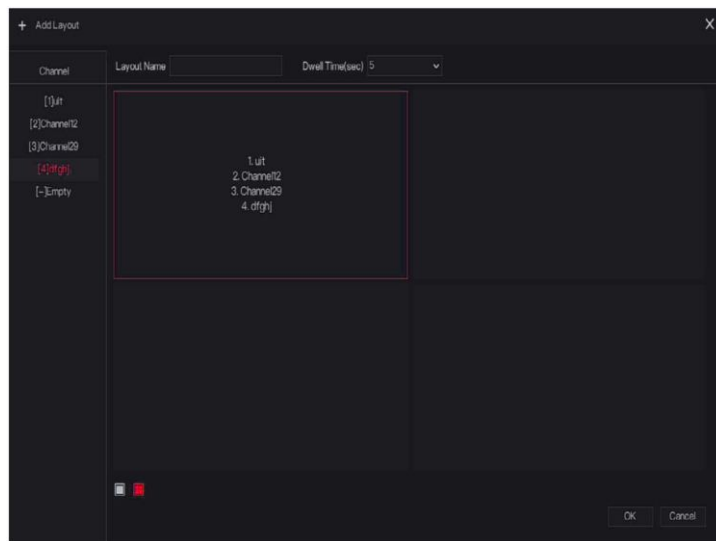
Layout. User can choose layout and add new layout strategies as shown in Figure 6-3 Click  on the right of the screen splitting format and choose the channels to view the video.

Figure 6-3 Add Layout



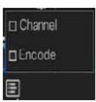
Input the layout name, choose the dwell time, choose the splitting format. Choose one channel or many channels to add on screen.



:Auto SEQ. click icon, the layout dwell on screen is enabled, for how to set the dwell on, please see *chapter 7.5.4*



:Audio. Click icon, the audio setting screen is displaying, which you can choose the channel and adjust the volume.



:Channel information, tick the channel or encode, the live video will show the channel information.



:Live view strategy, user can depend on the network to switch the strategy, there are three modes, such as fluency, balanced and real-time.

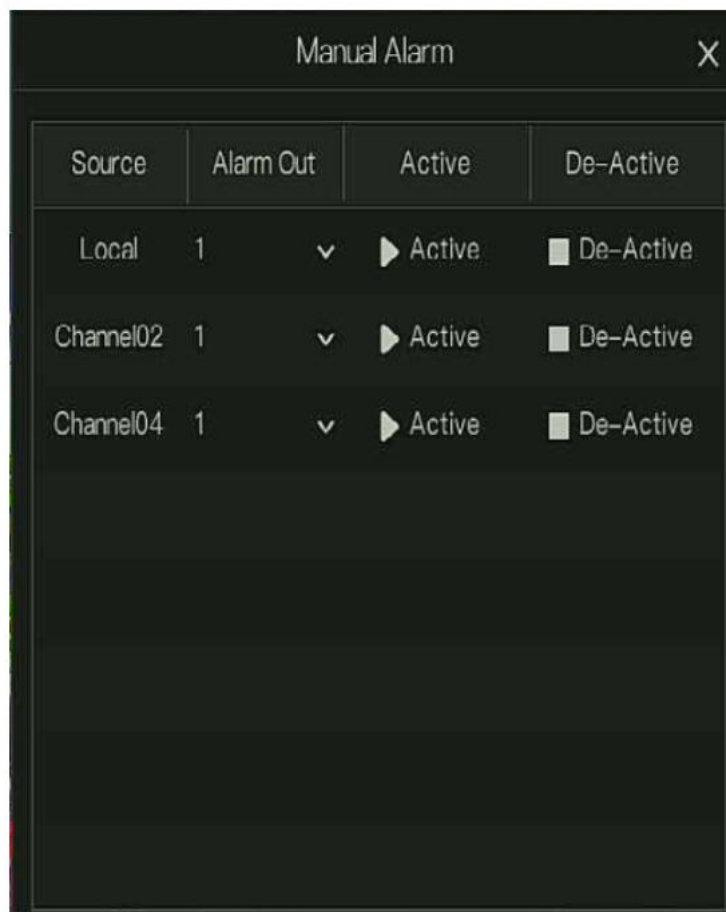
A main menu quick toolbar is display on the right of NVR floating menu bar. The main menu quick toolbar provides manual alarm, alarm information, clean alarm information and time, as shown in Figure 6-4

Figure 6-4 Main menu quick toolbar



:Manual alarm, click the icon, user can set different channels, choose alarm out, the window shows in Figure 6-5.

Figure 6-5 Manual alarm



:Alarm message, click icon would show pop-up message window, as shown in 6.6

## 6.1 Alarm message

Figure 6-6 Alarm message

| Pop up message to monitor |                  |                     |
|---------------------------|------------------|---------------------|
| Channel                   | Type             | Start Time          |
| Channel14                 | Motion Detection | 27/04/2020 11:02:32 |
| Channel14                 | Motion Detection | 27/04/2020 11:02:22 |
| Channel8                  | Video Loss       | 27/04/2020 11:02:18 |
| Channel14                 | Motion Detection | 27/04/2020 11:02:07 |
| Channel14                 | Motion Detection | 27/04/2020 11:01:55 |
| Channel14                 | Motion Detection | 27/04/2020 11:01:17 |
| Channel14                 | Motion Detection | 27/04/2020 11:00:01 |
| Channel14                 | Motion Detection | 27/04/2020 10:59:41 |
| Channel14                 | Motion Detection | 27/04/2020 10:59:30 |
| Channel14                 | Motion Detection | 27/04/2020 10:59:08 |
| Channel14                 | Motion Detection | 27/04/2020 10:58:44 |
| Channel14                 | Motion Detection | 27/04/2020 10:58:01 |



:Clean alarm, click icon and clean the current alarm actions like voice and external alarm out.



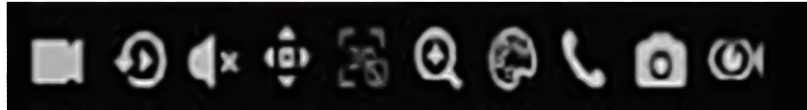
:Information, click icon and the general information would show, like network, system, channel, disk and alarm, as shown in Figure 6-6

Figure 6-7 Information

| System               | Network | Channel | Disk              | Alarm             |
|----------------------|---------|---------|-------------------|-------------------|
|                      |         |         | IP                | IPv4 CCTV         |
| Status               |         |         | Online            |                   |
| IP Address           |         |         | 192.168.2.48      | 192.168.99.121    |
| Subnet Mask          |         |         | 255.255.254.0     | 255.255.255.0     |
| Default Gateway      |         |         | 192.168.2.1       | 192.168.99.1      |
| MAC Address          |         |         | 00:1C:27:1B:E3:CD | 6A:C2:5E:D2:B7:02 |
| DHCP                 |         |         | OFF               |                   |
| Preferred DNS Server |         |         | 4.2.2.2           |                   |
| Alternate DNS Server |         |         | 8.8.8.8           |                   |
| Total Bandwidth      |         |         | 1000.00 Mbps      |                   |
| Received Packets     |         |         | 7.86 Mbps         |                   |

## 6.2 Real Time Video Bar

Click realtime image, the quick setting will show as figure.



Record: click the icon and start to record video. Click again to end record.

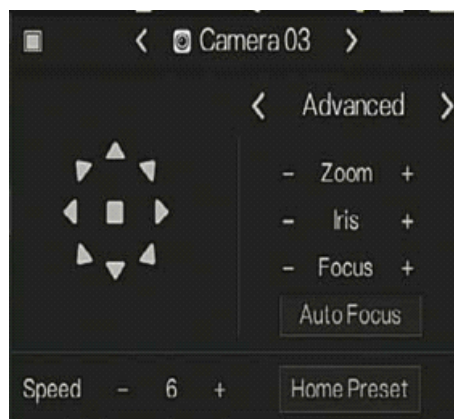
Instant playback: click the icon, the window will play previous five minutes record video.


 is the time bar of playback.

Audio : open or close the audio.


PTZ : This function only is useful for speed dome cameras. You can adjust every parameter as shown in Figure 6.8


Figure 6-8 PTZ adjust screen



 : User adjust direction of camera

 : At this part, user can set Advanced, Scan and Tour settings.

 : 3D, this function only can be used for high speed dome camera. Click the icon to enter the camera live video screen, use the mouse to move the camera or zoom in or out the lens. Click the point to zoom in. Drag and draw the area, zoom in the drawing area, Reverse drag to zoom out.

 : Zoom in, click zoom in, roll the mouse wheel to zoom in and zoom out. Right-click to exit the zooming.


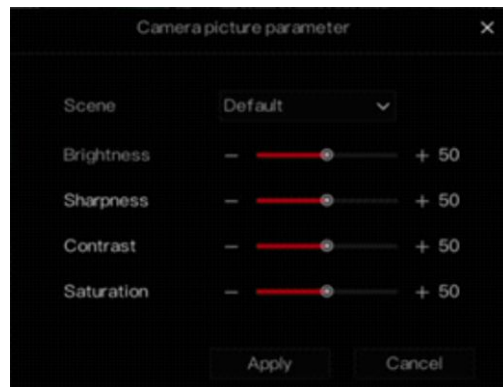
 : Image, click the icon, as shown in Figure 6.9. Select scene, and drag cursor to adjust value of brightness, sharpness, contrast and saturation.

Figure 6-9 Camera picture parameter



: Two way audio. The NVR and camera can talk to each other.

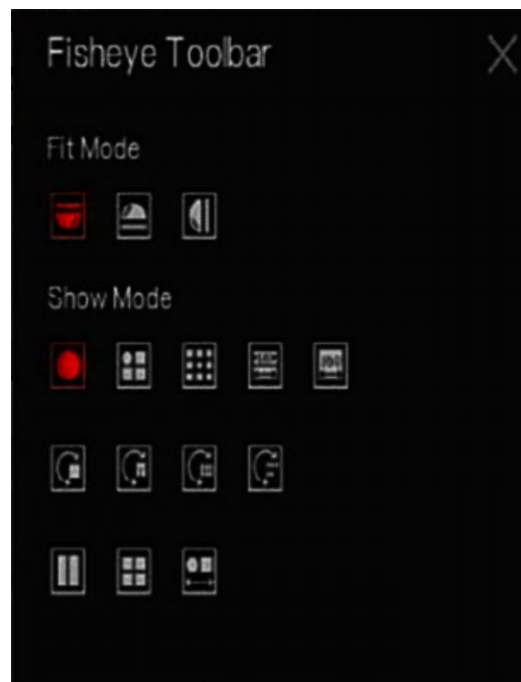


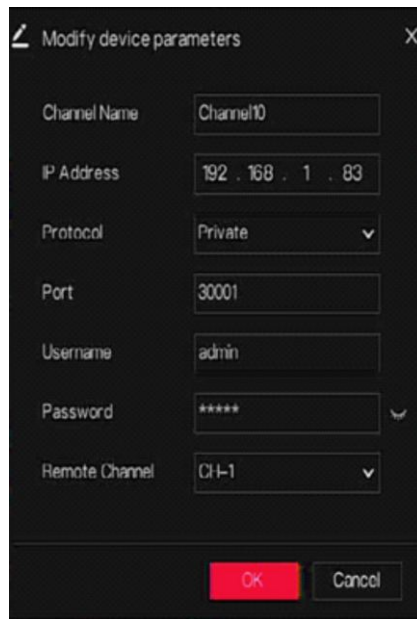
: Snapshot panorama if the USB disk is plugging in the NVR.



: fisheye (only used for fisheye cameras), click to switch the fisheye modes, as shown in Figure 6.10.

Figure 6-10 Fisheye





### 6.3 Playback

Playback refers to playing back a video, fixed-point playback, playback the search type.


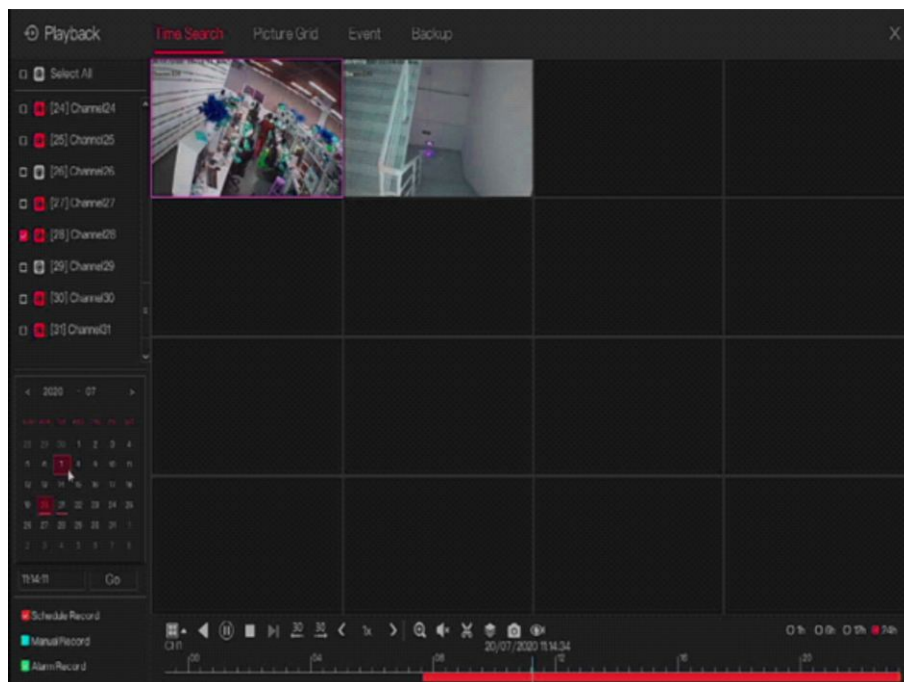
Click  in the quick navigation bar to access the playback screen, as shown in Figure 6-11


Figure 6-11 Playback screen




The toolbar at the bottom of the playback screen is described as follows:




:Layout

:Reversed, pause/play, stop.

:30s backward, 30s forward.

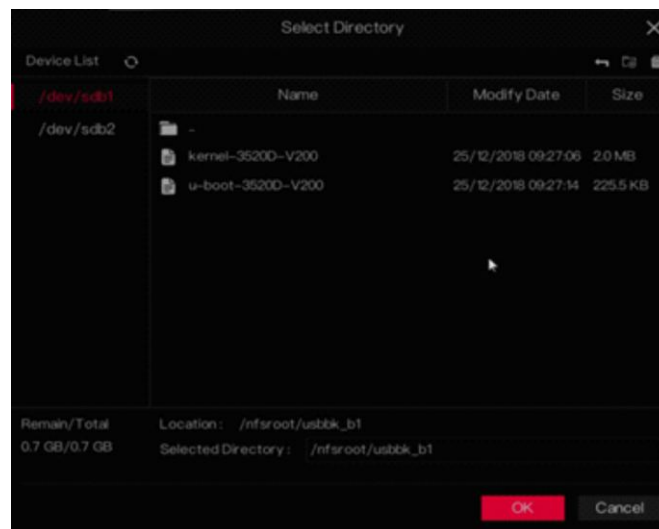
:Triple speed, it supports up to 32 times to playback. Click the Number can choose the speed quickly


:Audio.

:Start and end backup. Click the icon, the video backup starts, select the video and click the icon again.

The backup type shows, click save, then saving the file pop-up windows would show as Figure 6-12. Click **OK** to save. This function is available after a USB disk is plugging in the device.

Figure 6-12 Select directory

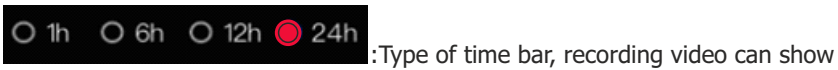
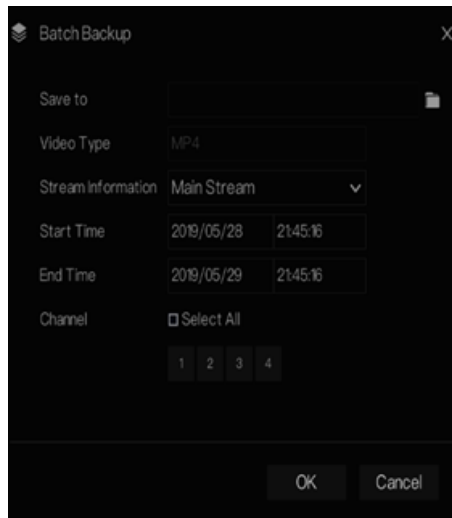


:Batch backup, click the icon to backup multi-channels, as shown in Figure 6-13

Choose the folder to save, select the stream information from drop-down list, set the start time and end time, select the channels, Click OK to backup. the backup videos are marked by watermark, you can view it by our player.

:snapshot panorama if the USB disk is plugging in the NVR.

Figure 6-13 Batch backup



### 6.3.1 Time Search

Search refers to searching for a video by date and time.

Operation Description


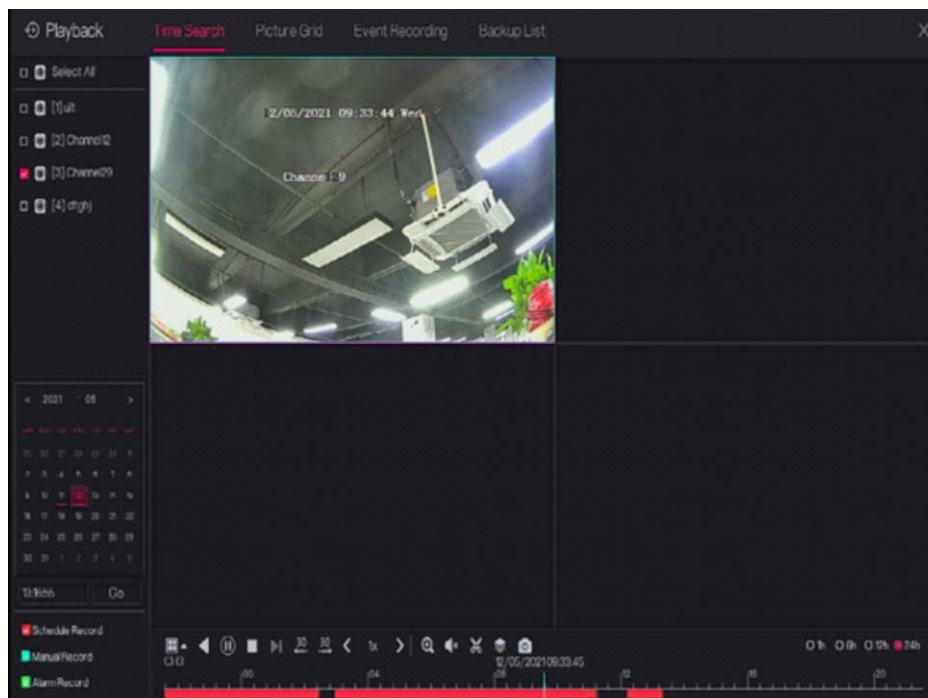
Click  in the quick navigation bar to access the search screen, as shown in Figure 6-14.

Figure 6-14 Time Search screen





### Operation Steps

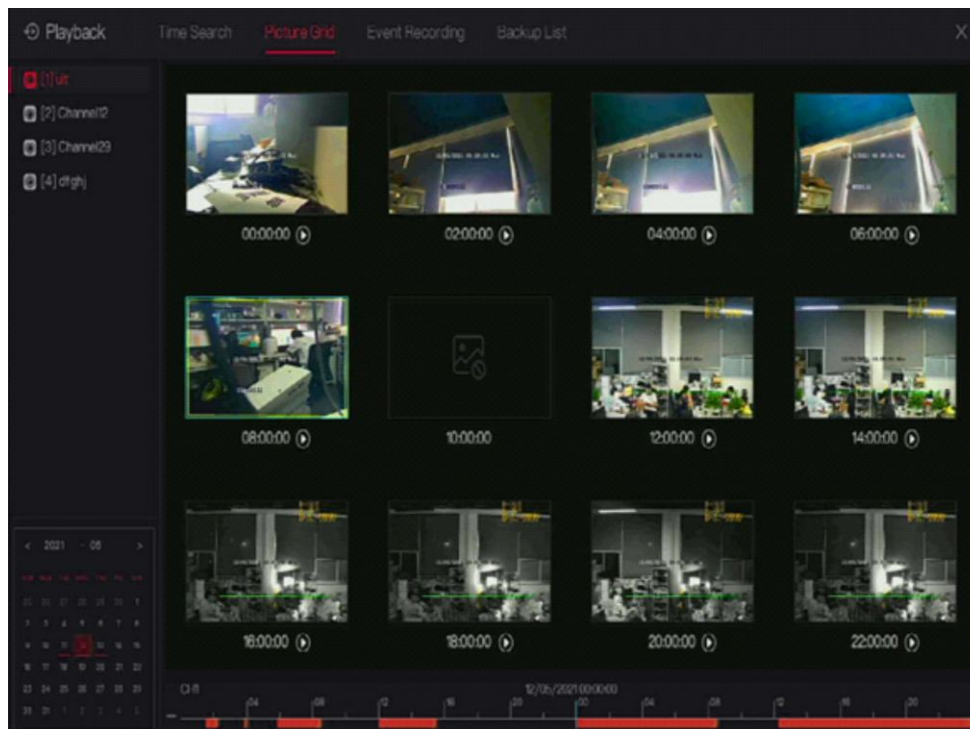
- Step 1 Select a camera in the camera list on the left side of the search screen. The video view of the selected camera is displaying in the play window.
- Step 2 Select a date in the calendar on the light-down side of the search screen.
- Step 3 Choose record type, and search the video quickly.
- Step 4 Choose proper button to adjust video.

### 6.3.2 Picture Grid

Picture grid refers to evenly dividing the video of a channel by time range and searching for a video based on thumbnails divided by time range.

Click **Picture Grid** on the quick navigation bar to access the picture grid screen, as shown in Figure 6-15

Figure 6-15 Picture grid screen



### Operation Steps


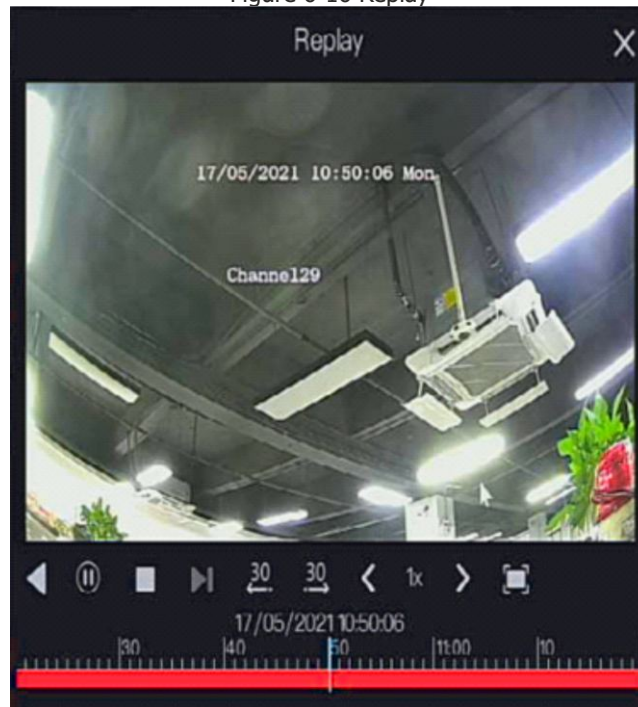
- Step 1 Select a camera in the camera list on the left side of the picture grid screen. Videos shot by the camera in the earliest time range on the current day are displayed as thumbnails in the window on the right side.
- Step 2 Select a day from calendar
- Step 3 A day are dividend to 12 grids, two hours is one grid. Click the image to change the interval.
- Step 4 Select a required thumbnail, double-click it or right-click it and choose Play from the shortcut menu to play the video.
- Step 5 Click  to replay the gird individually.

Figure 6-16 Replay



### 6.3.3 Event Recording


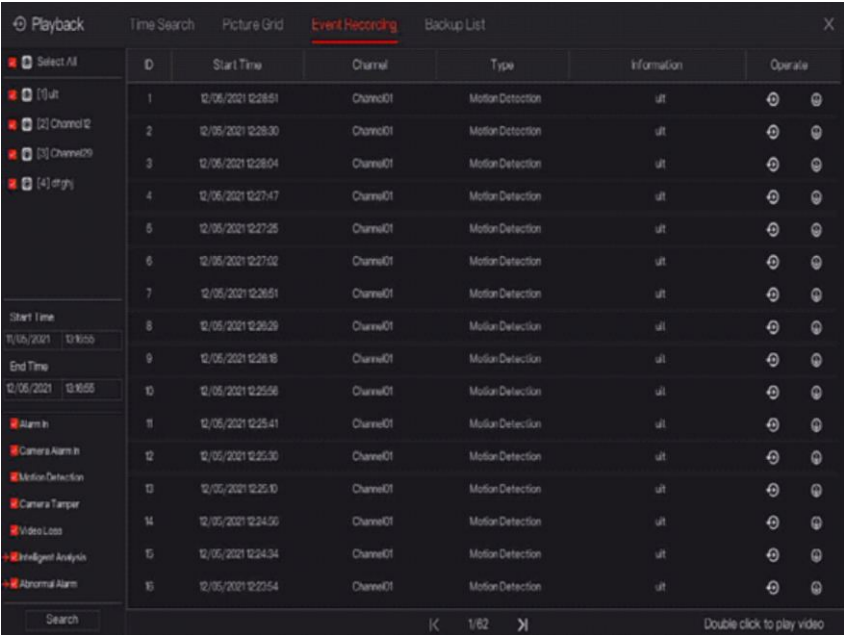
Click  on the quick navigation bar; choose **Event** at title to access the alarm event screen, as shown in Figure 6-17

Figure 6-17 Event screen



| ID | Start Time          | Channel   | Type             | Information | Operate |
|----|---------------------|-----------|------------------|-------------|---------|
| 1  | 12/05/2021 12:28:51 | Channel01 | Motion Detection | url         | ⏪ ⏩     |
| 2  | 12/05/2021 12:28:30 | Channel01 | Motion Detection | url         | ⏪ ⏩     |
| 3  | 12/05/2021 12:28:04 | Channel01 | Motion Detection | url         | ⏪ ⏩     |
| 4  | 12/05/2021 12:27:47 | Channel01 | Motion Detection | url         | ⏪ ⏩     |
| 5  | 12/05/2021 12:27:25 | Channel01 | Motion Detection | url         | ⏪ ⏩     |
| 6  | 12/05/2021 12:27:02 | Channel01 | Motion Detection | url         | ⏪ ⏩     |
| 7  | 12/05/2021 12:26:51 | Channel01 | Motion Detection | url         | ⏪ ⏩     |
| 8  | 12/05/2021 12:26:29 | Channel01 | Motion Detection | url         | ⏪ ⏩     |
| 9  | 12/05/2021 12:26:16 | Channel01 | Motion Detection | url         | ⏪ ⏩     |
| 10 | 12/05/2021 12:25:56 | Channel01 | Motion Detection | url         | ⏪ ⏩     |
| 11 | 12/05/2021 12:25:41 | Channel01 | Motion Detection | url         | ⏪ ⏩     |
| 12 | 12/05/2021 12:25:30 | Channel01 | Motion Detection | url         | ⏪ ⏩     |
| 13 | 12/05/2021 12:25:10 | Channel01 | Motion Detection | url         | ⏪ ⏩     |
| 14 | 12/05/2021 12:24:50 | Channel01 | Motion Detection | url         | ⏪ ⏩     |
| 15 | 12/05/2021 12:24:34 | Channel01 | Motion Detection | url         | ⏪ ⏩     |
| 16 | 12/05/2021 12:22:54 | Channel01 | Motion Detection | url         | ⏪ ⏩     |

### Operation Steps

Step 1 Select cameras in the camera list on the left

Step 2 Set start and end time.

Step 3 Tick the alarm type, such as alarm in, camera alarm in, motion alarm, video loss, intelligent analysis and abnormal alarm

Step 4 Click **Search** to query the event, the result would show at window.

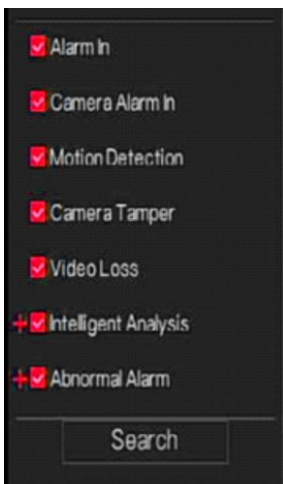
Step 5 Double click to play video about event. It will play recording video.



: play the recording video.



: backup the recording video.



the type of intelligent analysis and abnormal alarm are subdivided, user can tick the detail alarm to show.

Intelligent analysis includes perimeter, single virtual fence, double virtual fences, loiter, multi loiter, object left, object removed, abnormal speed, converse, illegal parking, signal bad, register, stranger, registered license plate, over temperature, low temperature, abnormal temperature, threshold warning, threshold alarm, temperature difference warning, temperature difference alarm, temperature section alarm, face temperature, wear mask, no mask, personnel count threshold alarm, personnel count threshold alarm(IPC) . Abnormal alarm includes disk error, IP conflict, network disconnected. User can choose the accurate alarm events to search.

### 6.3.4 Backup


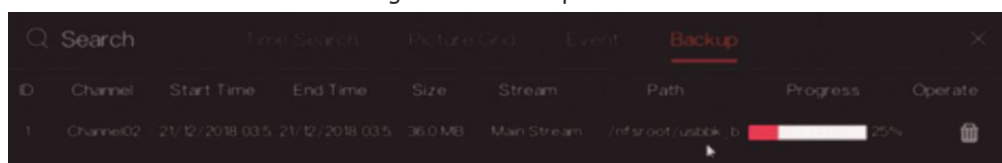
Click  on the quick navigation bar, choose **Backup** at title to access the backup screen, as shown in Figure 6-18

Figure 6-18 Backup screen



You can view the detail information of backup. Click delete button to quit the download.

## 6.4 AI Recognition (Only for Some Models)

At AI recognition interface, we can set the **Real time Comparison, Smart search, Archives library, Comparison configuration.**

The all snapshots support to add to the libraries according the real needs

### 6.4.1 Real Time Comparison

Real time comparison can compare human faces, vehicle license plate, and AI(include riding, vehicle, full body )

#### 6.4.1.1 Human Face


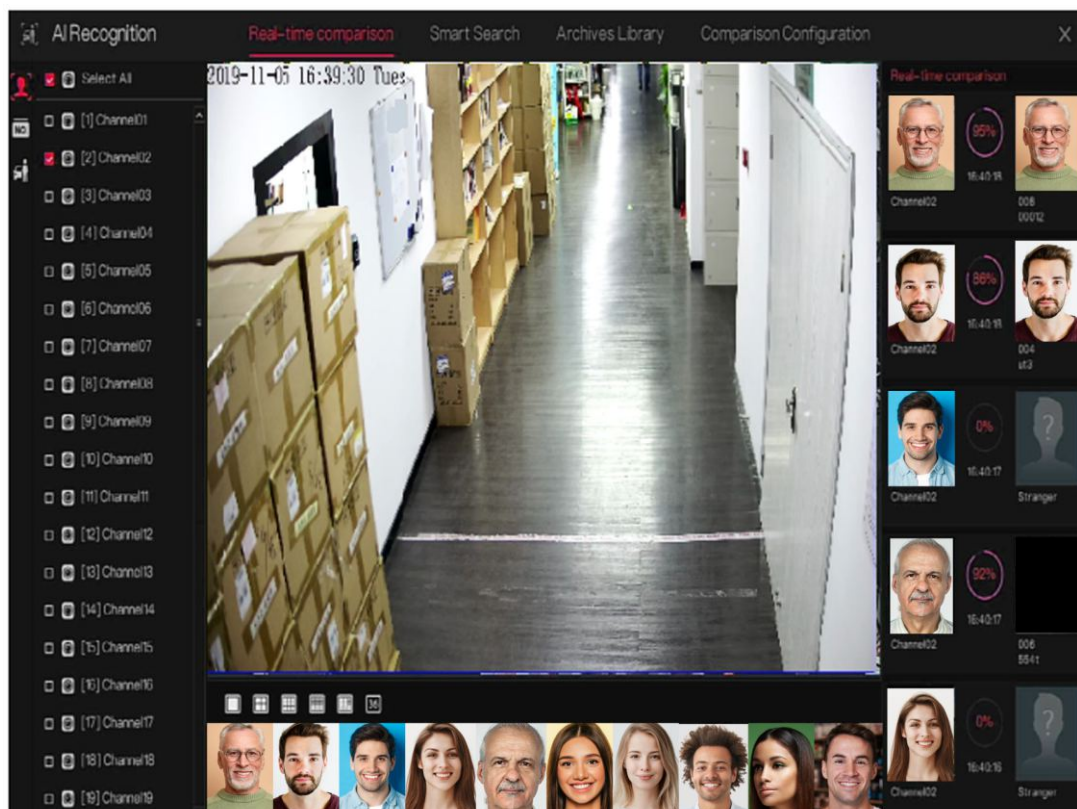

At real time comparison interface, click the  to enter the human face comparison interface, choose the cameras with face recognition function to play live video, the snapshots of camera will compare with the templates which has been registered in libraries, the result shows as in Figure 6-19.

Figure 6-19 Human face comparison



Click the "+" can add the snapshot to face library immediately.

Snapshot in real time video, put the cursor on picture such as , you can add it to face library, or face search. The cursor on area and the pictures are not update, move the mouse so that the pictures can be shown in time.

### 6.4.1.2 Vehicle License Plate

At real time comparison interface, click the **NO.** to enter the vehicle license plate comparison interface, choose the cameras with license plate recognition function to play live video, the snapshot of camera will be compared with libraries, the result shows as in Figure 6-20

Figure 6-20 Vehicle license plate

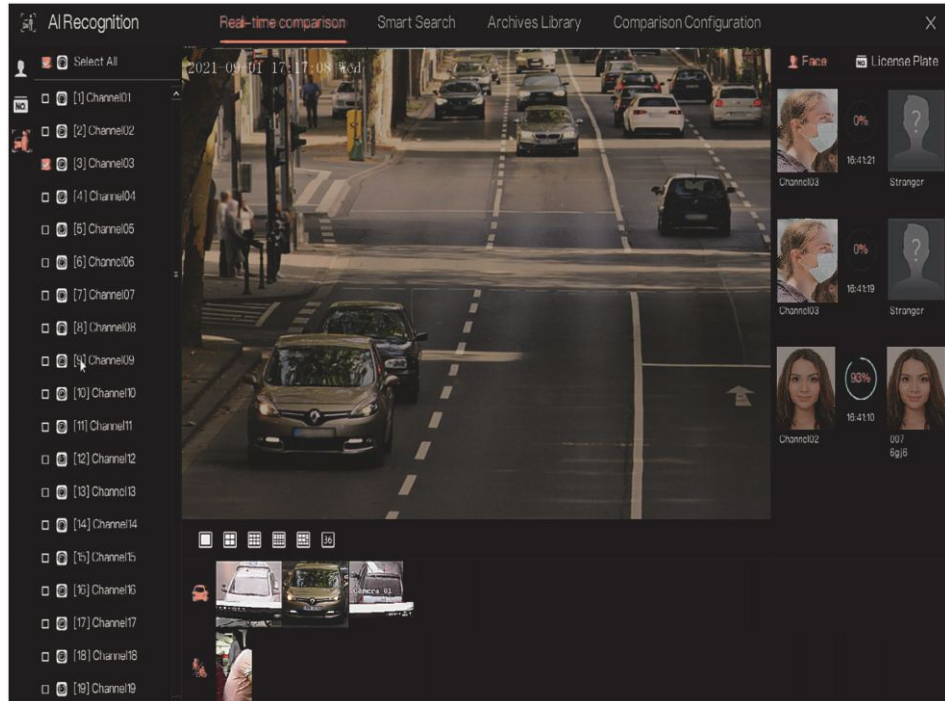


Click the "+" can add the snapshot to license plate library immediately.

### 6.4.1.3 Vehicle and Full Body

At real time comparison interface, click the **NO.** to enter the vehicle license plate comparison interface, choose the AI recognition cameras to play live video, the snapshot of camera will compare in libraries, the snapshot to vehicle and full body will show at the bottom of page, the result shows as in Figure 6-21.

Figure 6-21 Full body



#### 6.4.1.4 Real-time Body Temperature Filter


At AI recognition, click  to enter the real-time body temperature filter, user can choose human body temperature cameras to show, it will show the temperature recording and over temperature snapshots. Click full-screen, the channel list and snapshots statistics will be hidden.

Figure 6-22 Real-time body temperature filter

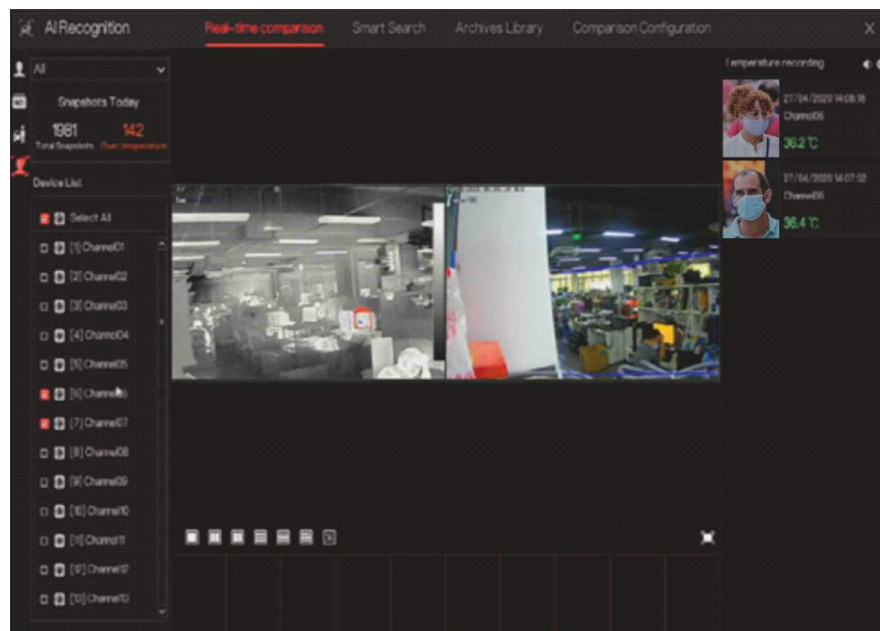
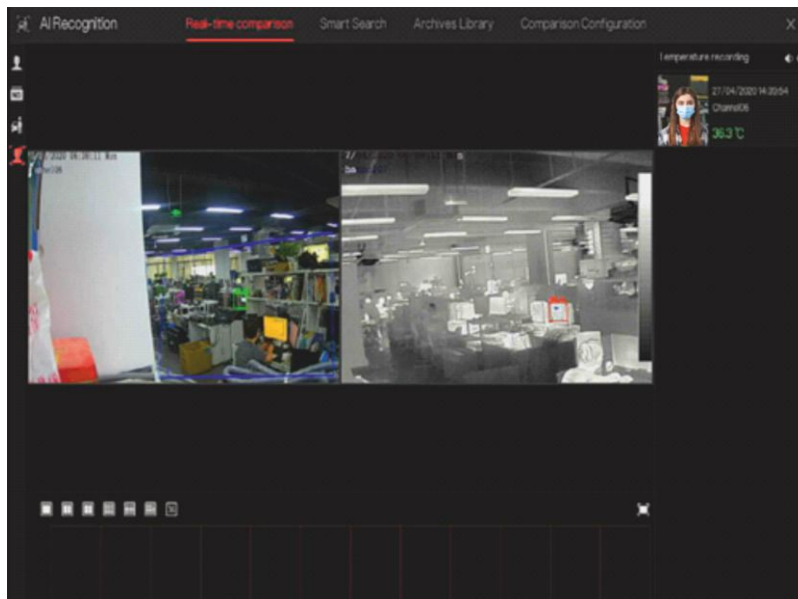


Figure 6-23 Full screen



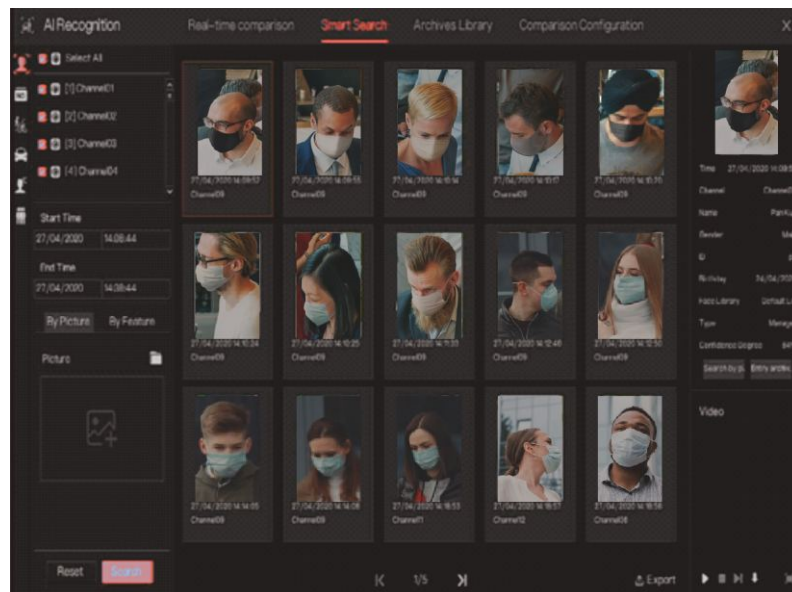
If user enable the mask detection, the results will show wear mask or no mask.

## 6.4.2 Smart Search

At smart search interface, user can search the human face, vehicle license plate, full body, car, body temperature. The limit of pictures showing is 1000, click picture to show detail information, result can be exported to flash disk.

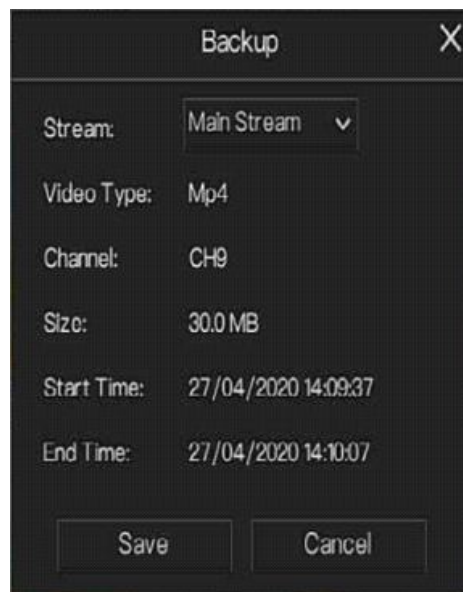
### 6.4.2.1 Human Face Search

Figure 6-24 Human face search



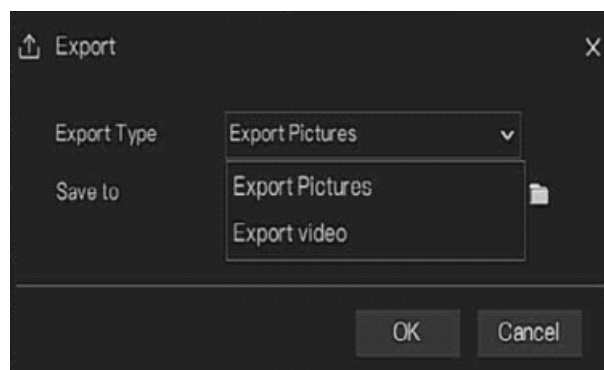
- Step 1 Choose human face search at smart search interface.
- Step 2 Tick the face recognition camera channels, set the start and end time.
- Step 3 Choose the condition (by picture or by feature), the picture can choose from the file folder.
- Step 4 Click "Search" to search the snapshot of human face.
- Step 5 The result will show at the middle of page, click the picture and the detail information show at the top right of page.
- Step 6 The detail picture can be used to search or add to library.
- Step 7 Click play button of video to play the recording of snapshot, click "Backup" to backup the recording videos.

Figure 6-25 Full screen




- Step 8 Click "Export" to export the result, choose export type pictures or videos.

Figure 6-26 Export



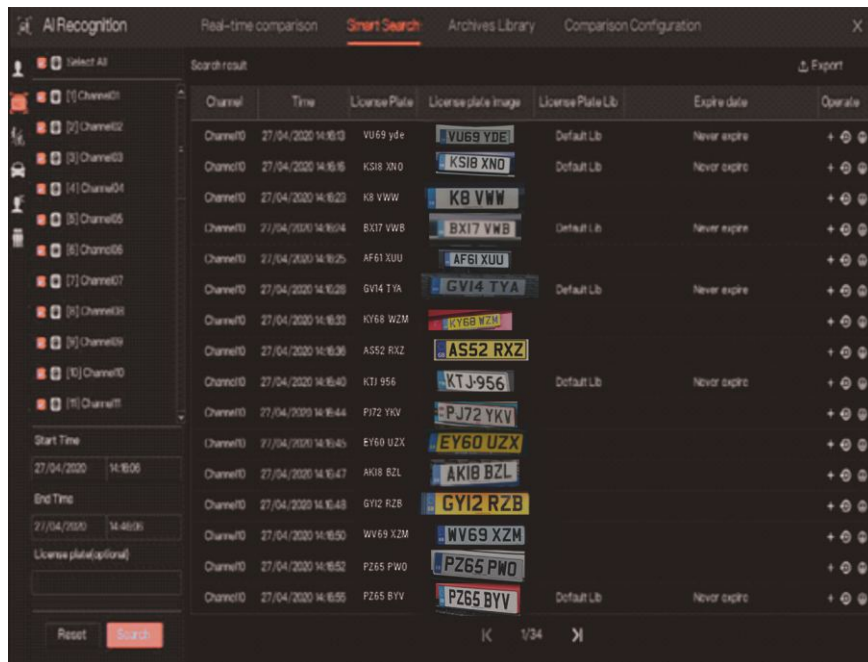
Play video of snapshot, it will play a 30-seconds video before and after the snapshot.



Snapshot in real time video, put the cursor on picture such as , you can add it to face library, or face search. The cursor on area and the pictures is not update, move the mouse so that the pictures can be shown in time.

### 6.4.2.2 Vehicle License Plate Search

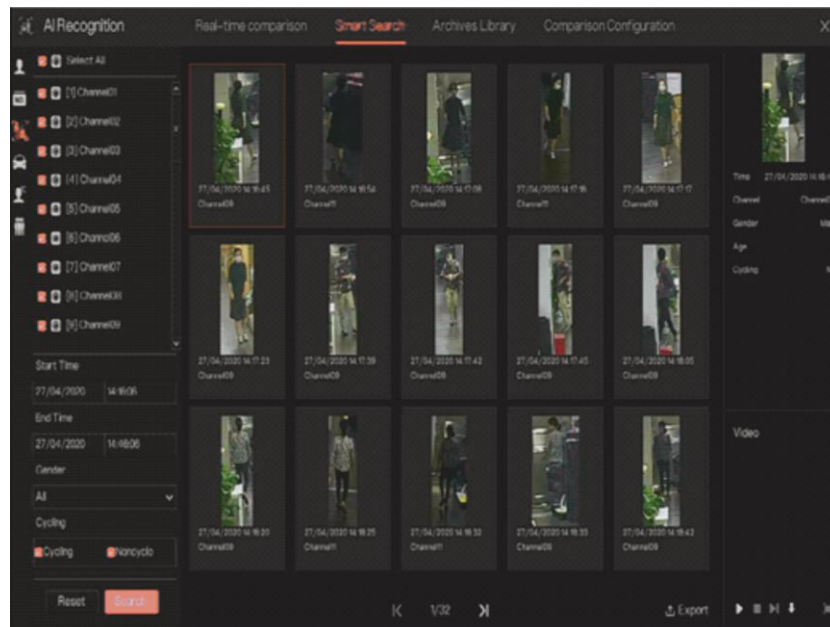
Figure 6-27 Vehicle License Plate search



- Step 1 Choose vehicle License Plate at smart search interface.
- Step 2 Tick the vehicle license plate recognition camera channels, set the start time and end time.
- Step 3 Input the license plate optionally.
- Step 4 Click "Search" to search the snapshot of license plate.
- Step 5 The result will show at the page, click "+" add to library.
- Step 6 Click "Playback" to view the recording video, click "Backup" to backup the video.
- Step 7 Click "Export" to export the result.

### 6.4.2.3 Full Body Search

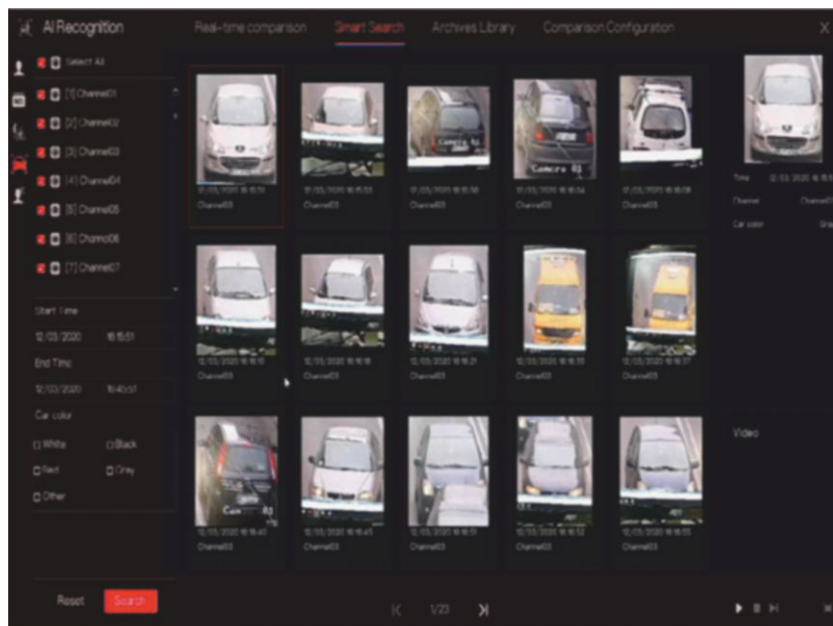
Figure 6-28 Full body search



- Step 1 Choose full body search at smart search interface.
- Step 2 Tick the AI recognition camera channels, set the start time and end time.
- Step 3 Set the gender, click cycling or no cycling .
- Step 4 Click "Search" to search the snapshot of human face.
- Step 5 The result will show at the middle of page, click the picture and the detail information show at the top right of page.
- Step 6 Click play button of video to play the recording of snapshot, click "backup" to backup the video.
- Step 7 Click "Export" to export the result.

## 6.4.2.4 Vehicle Search

Figure 6-29 Vehicle Search



Step 1 Choose vehicle search at smart search interface.

Step 2 Tick the AI recognition camera channels, set the start time and end time.

Step 3 Tick the color.

Step 4 Click "Search" to search the snapshot of human face.

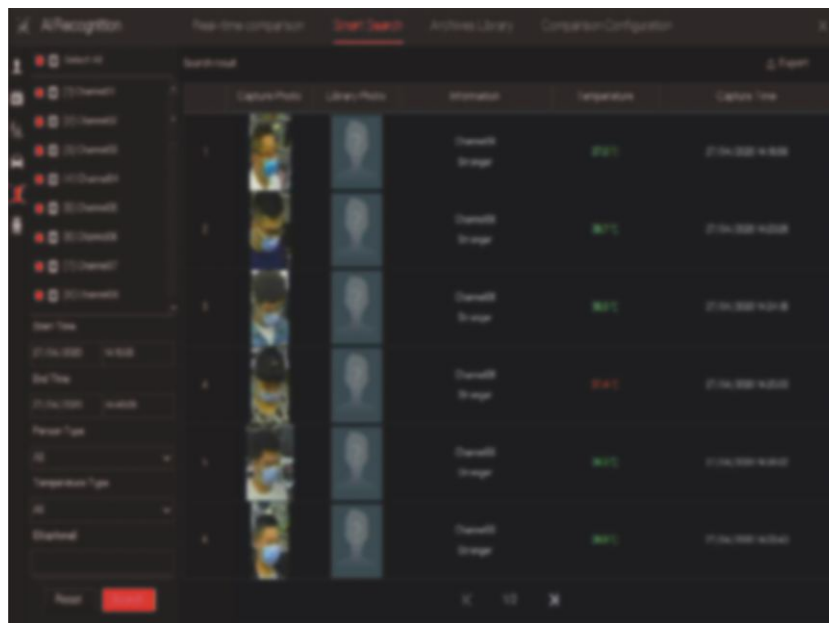
Step 5 The result will be showed at the middle of page, click the picture and the detail information show at the top right of page.

Step 6 Click play button of video to play the recording of snapshot, click "backup" to backup the video

Step 7 Click "Export" to export the result.

### 6.4.2.5 Body Temperature Search

Figure 6-30 Body temperature search

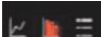


- Step 1 Choose body temperature search at smart search interface.
- Step 2 Tick the AI recognition camera channels, set the start time and end time.
- Step 3 Choose the person type, temperature type, input ID optionally.
- Step 4 Click "Search" to search the temperature.
- Step 5 Click "Export" to export the result

### 6.4.2.6 Personnel Count

Figure 6-31 Personnel Count



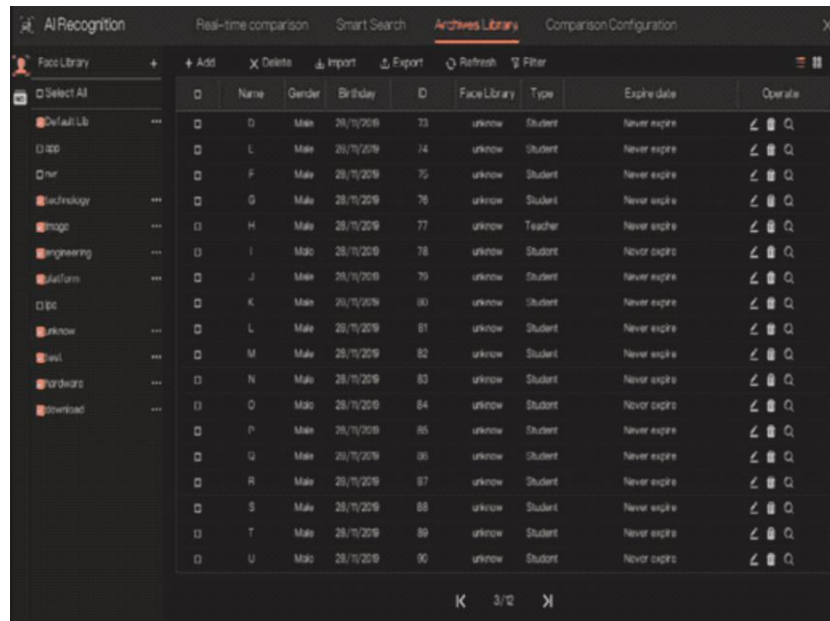
- Step 1 Choose personnel count at smart search interface.
- Step 2 Tick the AI recognition camera channels, set statistical type and date.
- Step 3 Click "Search" to search the snapshot of human face.
- Step 4 Click  to view the data by different manners.

### 6.4.3 Archives Library

At archives library, user can add or edit the face library, license plate library. The license plate libraries can be imported to and exported from IP cameras.

### 6.4.3.1 Face Library

Figure 6-32 Face library



Click “+” to add face library.

Click “Add” to add person enroll.

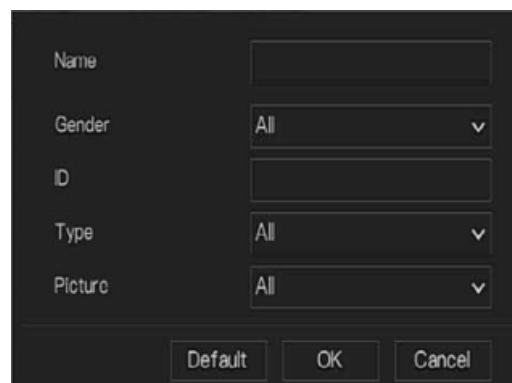
Tick the person, click “Delete” to delete the person.

Click “Import” to add the person batch.

Click “Export” to export the all person in library.

Click “Filter” to filter the all persons in library, as shown in Figure 6-33.

Figure 6-33 Filter

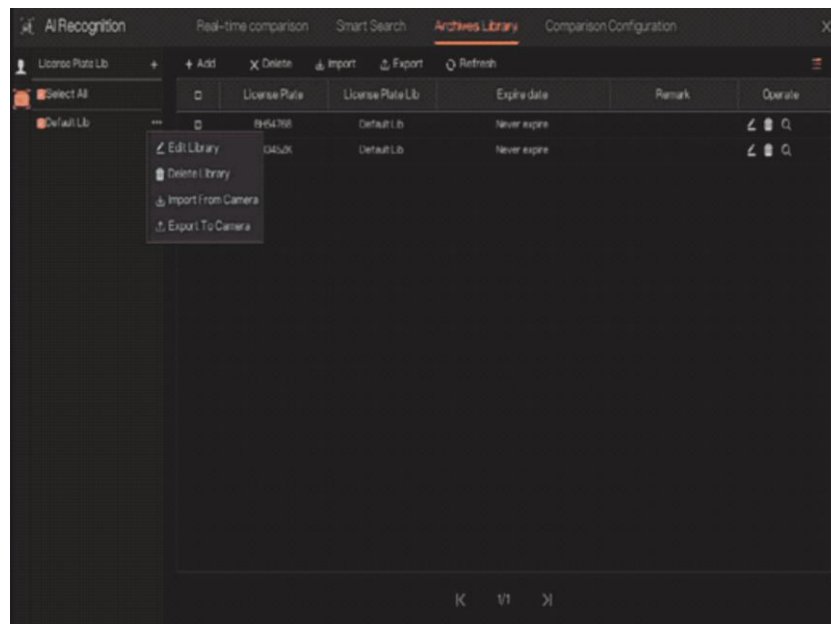


Click operate icon to edit or delete the chosen person.

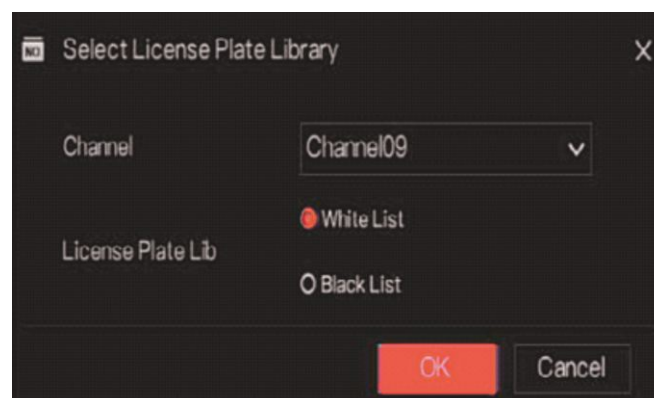
### 6.4.3.2 License Plate Library

At license plate library interface, user can add/delete/operate the library. It supports the white-list and black-list according the libraries to export and import the library to IP cameras.

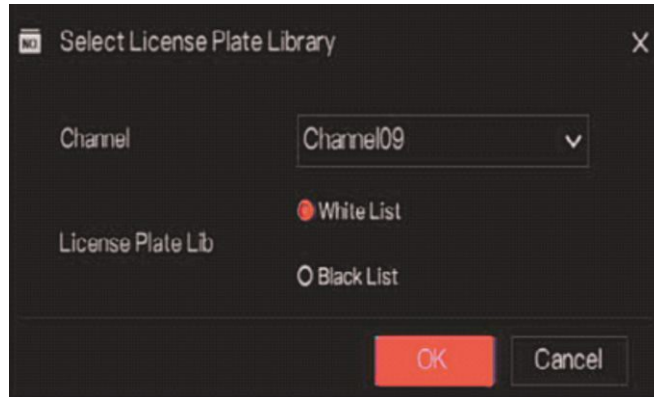
Figure 6-34 License plate library



- Click "+" to add license plate library.
- Click "Add" to add plate to library.
- Tick the plate, click "Delete" to delete the license plate.
- Click "Import" to add the license plate batch.
- Click "Export" to export the all-license plate library.
- Click operate icon to edit or delete the chosen license plate.
- Click "Import from Camera" to select license plate library to channel.



Click "Export to Camera" to add license plate number to camera.



## 6.4.4 Comparison Configuration



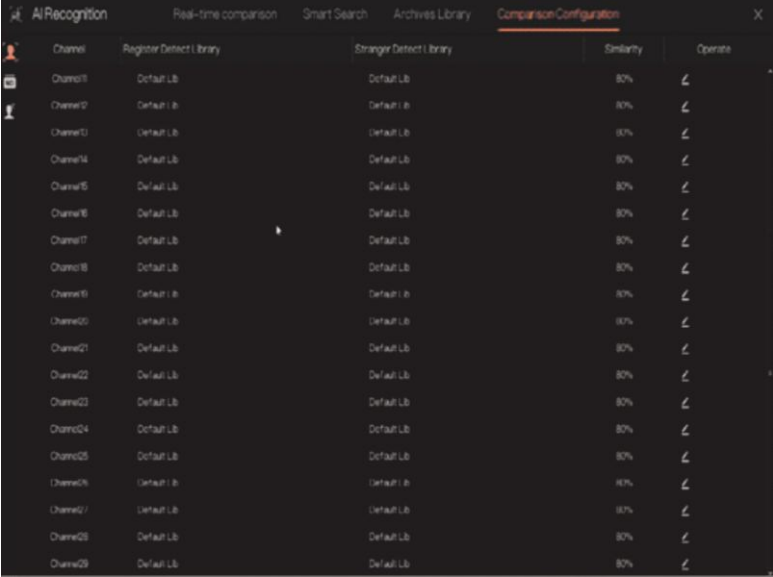
### NOTE

The comparison function is only for AI cameras, please refer to actual cameras. At comparison configuration interface, user can set the comparison of human face/ license plate/temperature/ mask detection configuration/ personnel count configuration.

### 6.4.4.1 Face Comparison

At face comparison interface, user can set different channels' strategy, such as similarity, display comparison result, face library, enable alarming, event action, arming time, as shown in Fig 6-35.

Figure 6-35 Face comparison



| Channel   | Register Detect Lib | Stranger Detect Lib | Similarity | Operate |
|-----------|---------------------|---------------------|------------|---------|
| Channel01 | Default Lib         | Default Lib         | 80%        | ⚙️      |
| Channel02 | Default Lib         | Default Lib         | 80%        | ⚙️      |
| Channel03 | Default Lib         | Default Lib         | 85%        | ⚙️      |
| Channel04 | Default Lib         | Default Lib         | 80%        | ⚙️      |
| Channel05 | Default Lib         | Default Lib         | 80%        | ⚙️      |
| Channel06 | Default Lib         | Default Lib         | 80%        | ⚙️      |
| Channel07 | Default Lib         | Default Lib         | 80%        | ⚙️      |
| Channel08 | Default Lib         | Default Lib         | 80%        | ⚙️      |
| Channel09 | Default Lib         | Default Lib         | 80%        | ⚙️      |
| Channel10 | Default Lib         | Default Lib         | 80%        | ⚙️      |
| Channel11 | Default Lib         | Default Lib         | 80%        | ⚙️      |
| Channel12 | Default Lib         | Default Lib         | 80%        | ⚙️      |
| Channel13 | Default Lib         | Default Lib         | 80%        | ⚙️      |
| Channel14 | Default Lib         | Default Lib         | 80%        | ⚙️      |
| Channel15 | Default Lib         | Default Lib         | 80%        | ⚙️      |
| Channel16 | Default Lib         | Default Lib         | 80%        | ⚙️      |
| Channel17 | Default Lib         | Default Lib         | 80%        | ⚙️      |
| Channel18 | Default Lib         | Default Lib         | 80%        | ⚙️      |
| Channel19 | Default Lib         | Default Lib         | 80%        | ⚙️      |
| Channel20 | Default Lib         | Default Lib         | 80%        | ⚙️      |



Figure 6-36 Face comparison



#### 6.4.4.2 License Comparison

At license plate interface, users can set strategies of different channels of license plate recognition cameras, such as register and unregister, enable alarming, event action, arming time, as shown in Figure 6-37.

Figure 6-37 License Comparison

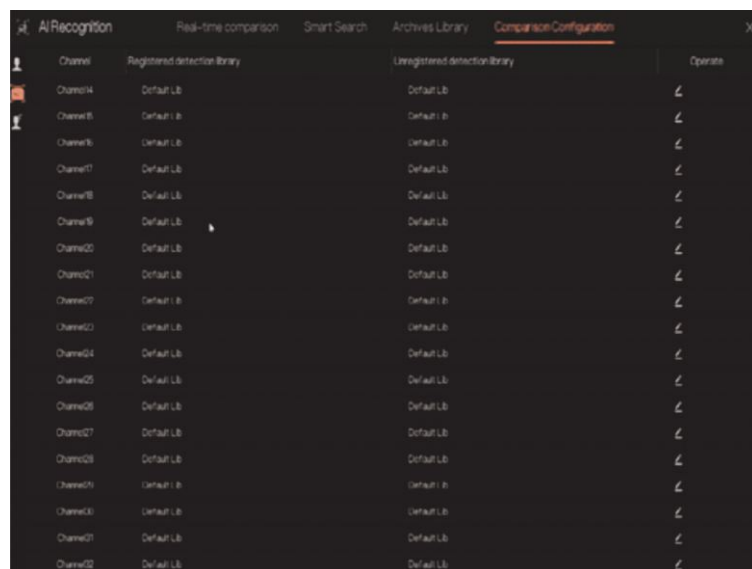
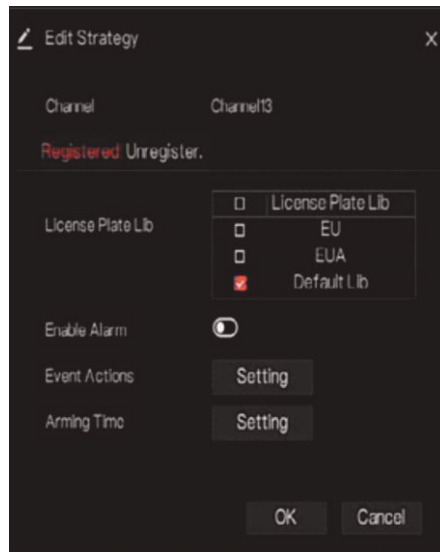


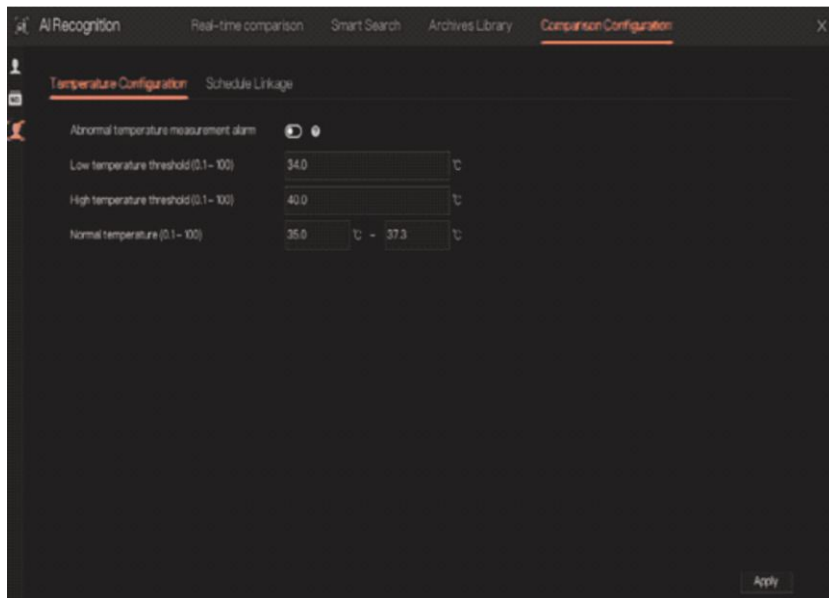
Figure6-38 Strategy



### 6.4.4.3 Temperature Comparison

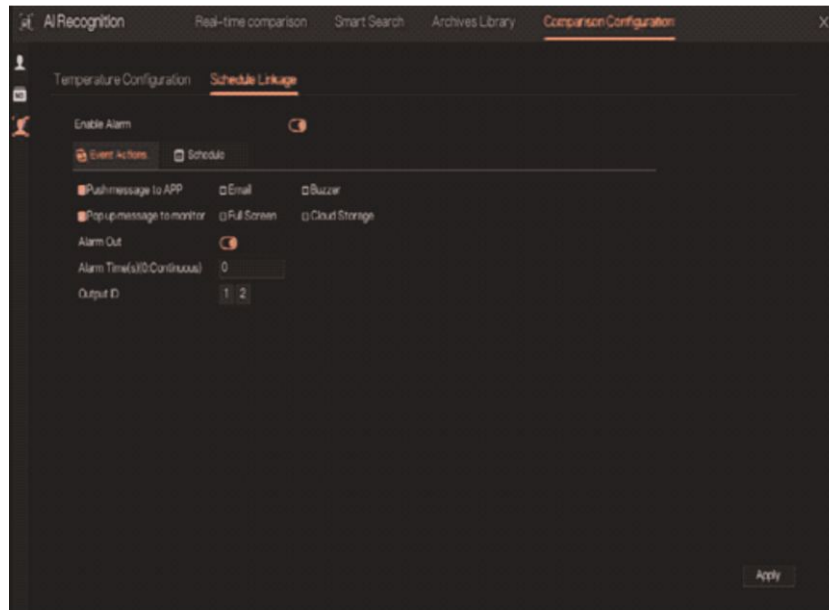
At comparison configuration interface, click  to enter the temperature configuration, as shown in Figure 6-39

Figure 6-39 Strategy



At temperature comparison interface, user can set low temperature threshold, high temperature threshold, normal temperature. Abnormal temperature measurement alarm, when it is turned on, the temperature below the low threshold and above the high temperature threshold will generate abnormal temperature alarm. When it is turned off, body temperatures below the low threshold and above the high threshold are discarded.

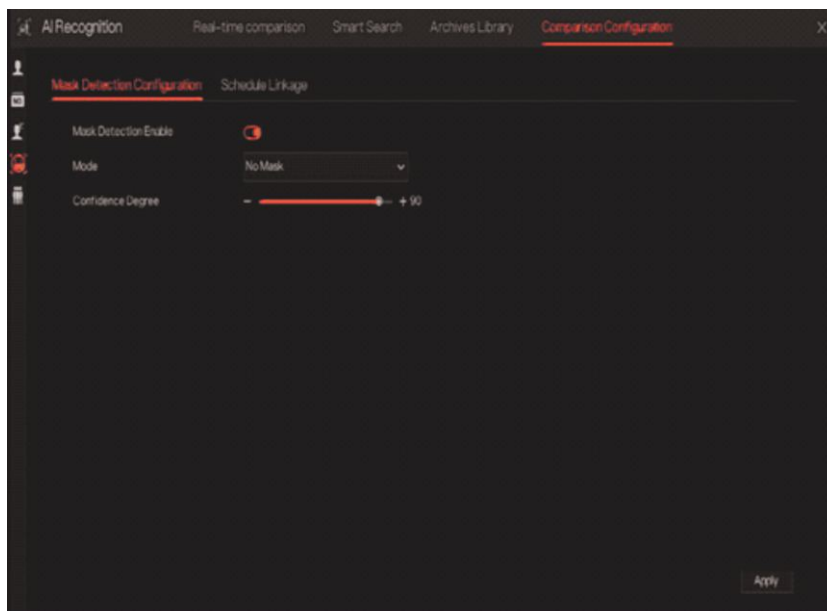
Figure 6-40 Schedule linkage



Enable alarm, set the schedule linkage, it will send alarm information if the temperature is higher than low threshold and lower the normal temperature, or higher than normal temperature and lower than high threshold.

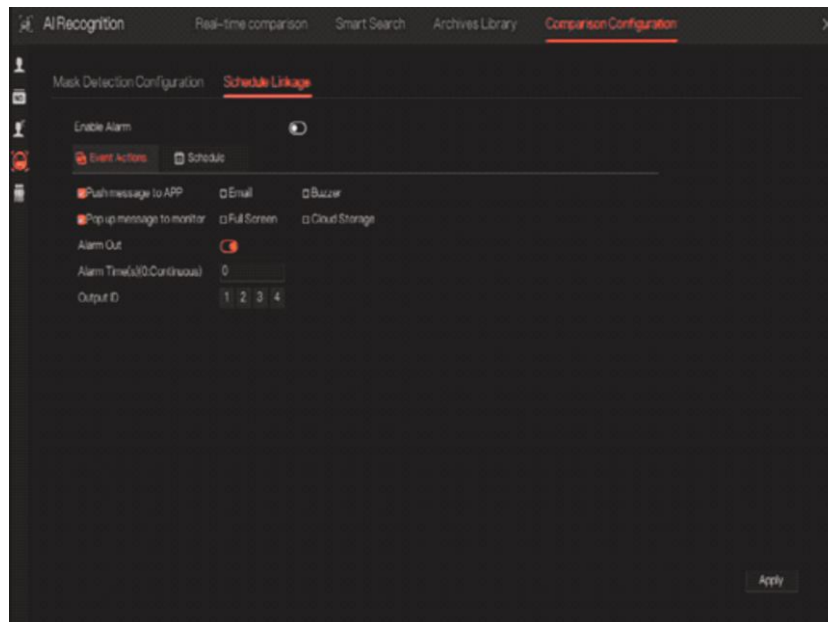
#### 6.4.4.4 Mask Detection Configuration

Figure 6-41 Mask Detection Configuration



Enable mask detection, choose the mode (no mask or wear mask). Set the confidence degree, the default value is 90

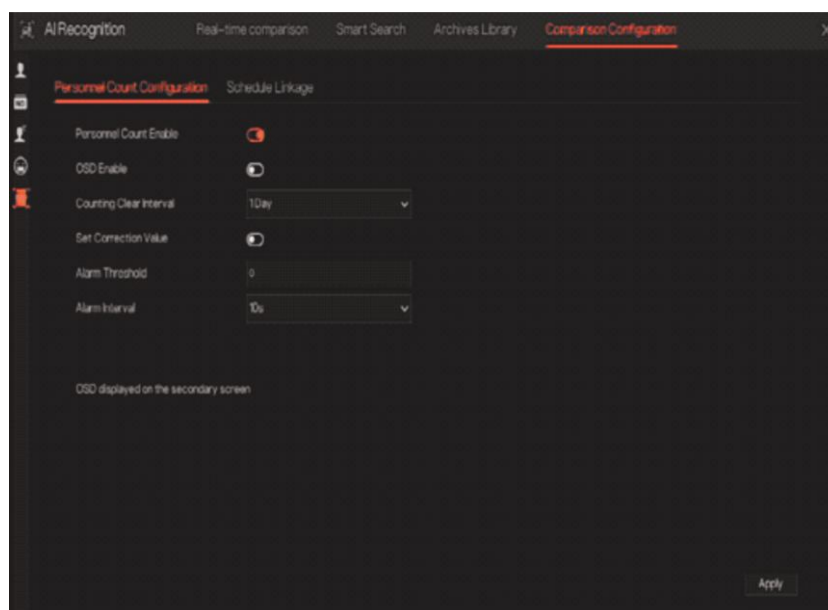
Figure 6-42 Schedule linkage



Enable the alarm, the real-time comparison can show if one the wear mask or not.  
 Choose event actions, and set the schedule.  
 Click "Apply" to save the settings.

#### 6.4.4.5 Personnel Count Configuration

Figure 6-43 Personnel count configuration



Enable personnel count to start the people counting.

Enable OSD to show OSD (OSD is displayed on the auxiliary screen, you need to start the auxiliary screen in "System> Auxiliary Screen" before displaying).

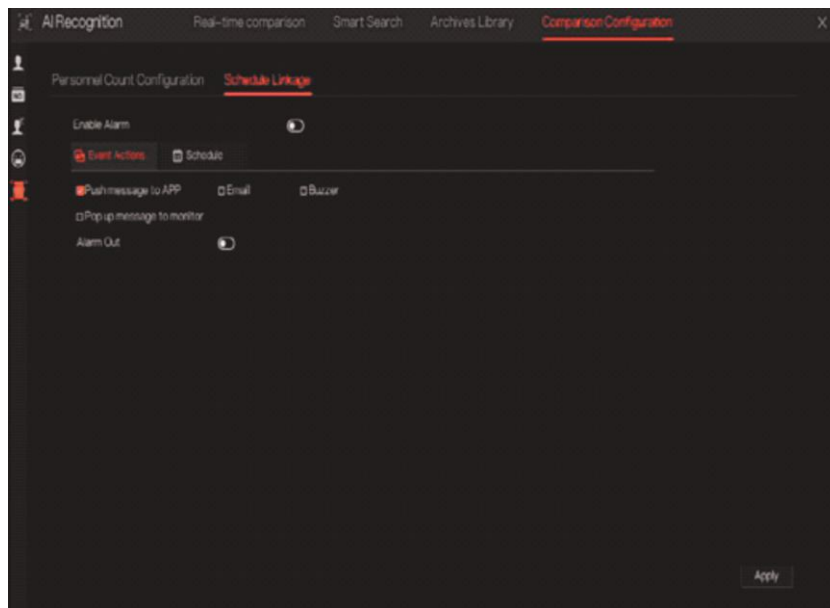
Select the counting clear interval (never, 10 minutes, half an hour, 1 hour, 12 hours, 1 day).

Set correction value, Configure the calibration value to start the manual calibration of the personnel count value.

Alarm threshold: when the number of people counts reaches the threshold, an alarm is activated. Alarm interval: 10s, 20s, 30s, 40s, 50s, 60s.

Click "Apply" to save the settings.

Figure 6-44 Schedule linkage



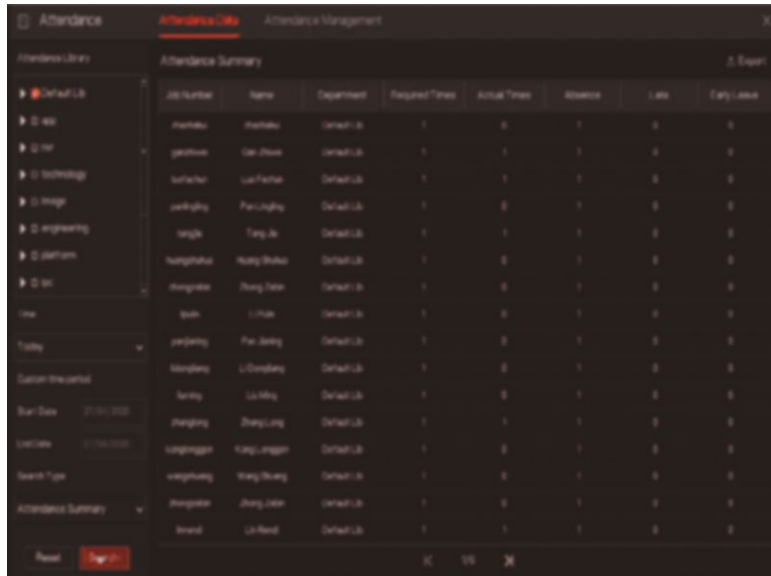
Set schedule linkage action to alarm.

## 6.5 Attendance (Only for Some Models)

### 6.5.1 Attendance Data

Click to enter attendance data interface, as shown in Figure 6-45

Figure 6-45 Attendance data



| Attendance Library | Job Number | Name        | Department  | Required Times | Actual Times | Absence | Late | Early Leave |
|--------------------|------------|-------------|-------------|----------------|--------------|---------|------|-------------|
| Default Lib        | 1000001    | John Doe    | Default Lib | 1              | 1            | 0       | 0    | 0           |
| 1000002            | Jane Smith | Default Lib | 1           | 1              | 0            | 0       | 0    |             |
| 1000003            | John Doe   | Default Lib | 1           | 1              | 0            | 0       | 0    |             |
| 1000004            | Jane Smith | Default Lib | 1           | 1              | 0            | 0       | 0    |             |
| 1000005            | John Doe   | Default Lib | 1           | 1              | 0            | 0       | 0    |             |
| 1000006            | Jane Smith | Default Lib | 1           | 1              | 0            | 0       | 0    |             |
| 1000007            | John Doe   | Default Lib | 1           | 1              | 0            | 0       | 0    |             |
| 1000008            | Jane Smith | Default Lib | 1           | 1              | 0            | 0       | 0    |             |
| 1000009            | John Doe   | Default Lib | 1           | 1              | 0            | 0       | 0    |             |
| 1000010            | Jane Smith | Default Lib | 1           | 1              | 0            | 0       | 0    |             |
| 1000011            | John Doe   | Default Lib | 1           | 1              | 0            | 0       | 0    |             |
| 1000012            | Jane Smith | Default Lib | 1           | 1              | 0            | 0       | 0    |             |
| 1000013            | John Doe   | Default Lib | 1           | 1              | 0            | 0       | 0    |             |
| 1000014            | Jane Smith | Default Lib | 1           | 1              | 0            | 0       | 0    |             |
| 1000015            | John Doe   | Default Lib | 1           | 1              | 0            | 0       | 0    |             |
| 1000016            | Jane Smith | Default Lib | 1           | 1              | 0            | 0       | 0    |             |
| 1000017            | John Doe   | Default Lib | 1           | 1              | 0            | 0       | 0    |             |
| 1000018            | Jane Smith | Default Lib | 1           | 1              | 0            | 0       | 0    |             |
| 1000019            | John Doe   | Default Lib | 1           | 1              | 0            | 0       | 0    |             |
| 1000020            | Jane Smith | Default Lib | 1           | 1              | 0            | 0       | 0    |             |

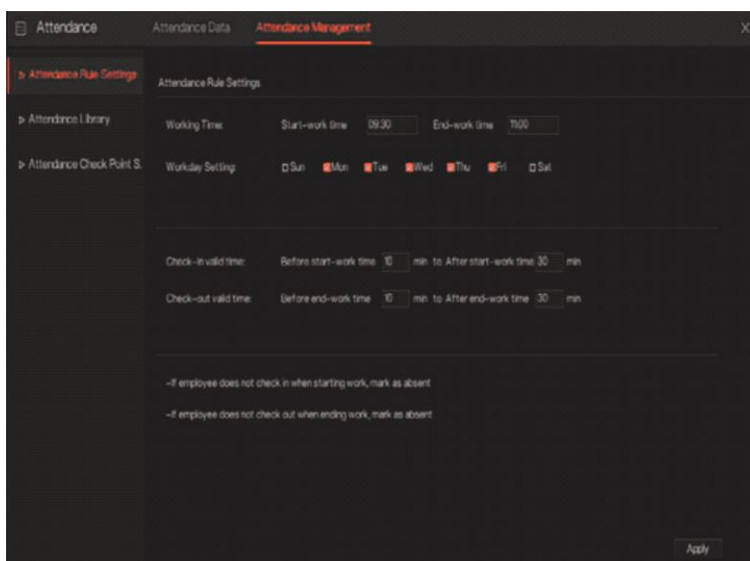
### Operation Steps

- Step 1 Tick the attendance library.
- Step 2 Choose time mode, such as today, this week, this month and custom time.
- Step 3 Choose search type, such as attendance summary and attendance details.
- Step 4 Click search, the result will show in interface.
- Step 4 Click Export to export the query result

## 6.5.2 Attendance Management

In attendance management, user can set attendance rule, library and check point, as shown in Figure 6-46

Figure 6-46 Attendance data



Attendance Management

Attendance Rule Settings

Attendance Library

Working Time

Start-work time: 09:00 End-work time: 18:00

Attendance Check Point S.

Workday Setting

Sun  Mon  Tue  Wed  Thu  Fri  Sat

Check-in valid time: Before start-work time: 10 min to After start-work time: 30 min

Check-out valid time: Before end-work time: 10 min to After end-work time: 30 min

-If employee does not check in when starting work, mark as absent

-If employee does not check out when ending work, mark as absent

Apply

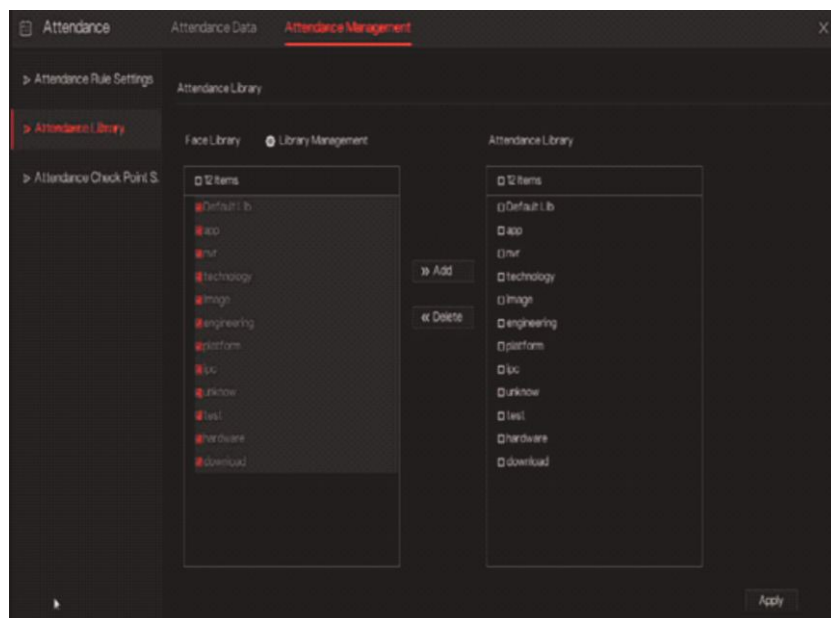
## Operation Steps

- Step 1 Set start work time and end work time.
- Step 2 Tick the workday
- Step 3 Set valid time of check in and check out.
- Step 4 Click Save to save the setting.

## Attendance library

- Step 1 Click **Attendance Library** to add library, the attendance library can call the face database directly.

Figure 6-46 Attendance library

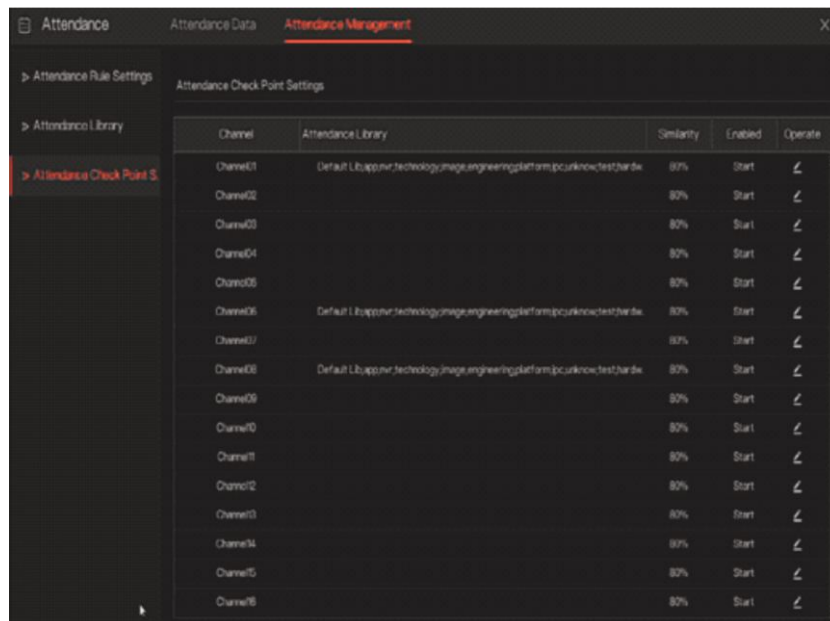


- Step 2 Tick the library and click Add to add to attendance library. If you want to modify the library.
- Step 3 Click **Database management** enter the face database management to modify parameter.
- Step 4 Click Save to save the setting.

## Attendance check point settings:

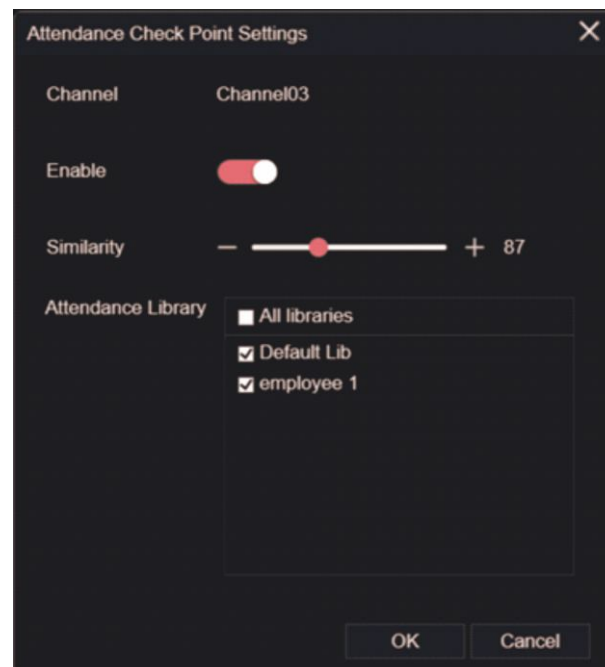
- Step 1 Click **Attendance check point** settings to set point, as shown in Figure 6-48

Figure 6-48 Attendance check point setting



Step 2 Click  Step 1to edit check point setting, as shown in Figure 6-49

Figure 6-49 Check point





- Step 3 Enable the function, set similarity and tick the library, all face detection cameras can be set the check points
- Step 4 Click **OK** to save the setting.

## 6.6 Thermal Temperature (Only for Some Models)



The thermal temperature function is only carried by some devices. If the current device does not have the function, please ignore it.

### 6.6 Temperature Parameters

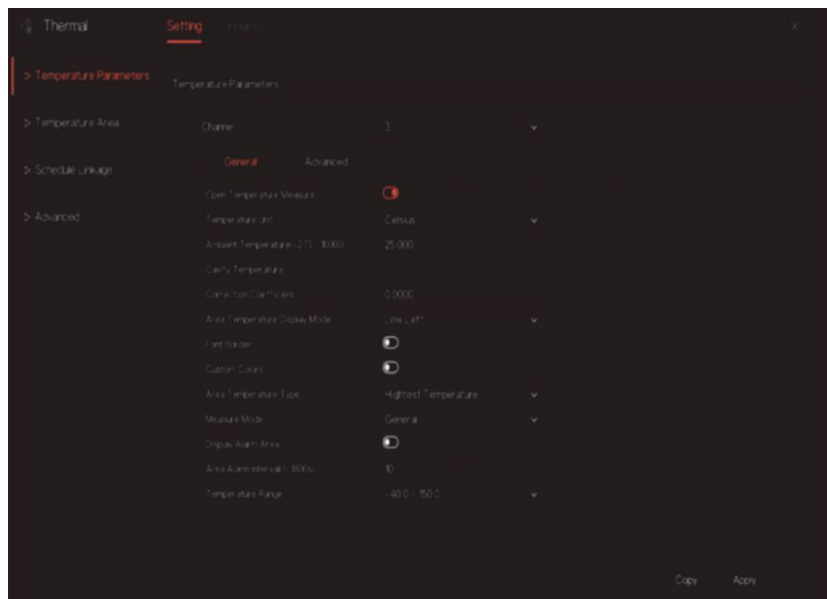
Temperature parameters include: temperature unit, ambient type, ambient temperature, cavity temperature, correctional coefficient and area temperature display mode.

#### Operation Procedure

Step 1 Choose Thermal > Temperature Parameters

The **Temperature Parameters** page is displayed, as shown in Figure 6-50

Figure 6-50 Temperature Parameters



Step 2 Set the parameters according to Table 6-1

Table 6-1 Temperature parameters

| Parameter                     | Description   | Setting   |
|-------------------------------|---|---|
| Open Temperature Measure      | Enable temperature measure.   |   |
| Temperature Unit              | Celsius and Fahrenheit temperature units are available.   | [Setting method]<br>Select a value from the drop-down list box.<br>[Default value] Celsius                |
| Ambient Temperature           | The ambient temperature of camera. It is set when ambient is outside.   | [Setting method]<br>Enter a value manually.   |
| Cavity Temperature            | The cavity temperature of camera.   | N/A   |
| Correction Coefficient        | Correction coefficient is refer to the deviation of measured object temperature and actual temperature<br>For example:<br>1. The measured object temperature is 30, and actual temperature is 37, so the correction coefficient should be 7.<br>2. The measured object temperature is 37, and actual temperature is 30, so the correction coefficient should be -7. | [Setting method]<br>Enter a value manually.<br>[Default value]<br>0.00                                    |
| Area Temperature Display Mode | The display position of temperature information on the live-video image.  | [Setting method]<br>Select a value from the drop-down list box.<br>[Default value]<br>Low left            |
| Font Border                   | The font will be bolded.  | [Setting method]<br>Enable or disable [Default value]<br>disable  |
| Custom Colors                 | Enable to custom the color, there are nine colors chosen.   | [Setting method]<br>Enable or disable [Default value]<br>disable  |
| Area Temperature Type         | There are three types of area temperature.  | [Setting method]<br>Select a value from the drop-down list box.<br>[Default value]<br>Highest Temperature |

| Parameter           | Description                       | Setting   |
|---------------------|-----------------------------------|---|
| Measure Mode        | There are two types measure modes | [Setting method]<br>Select a value from the drop-down list box.<br>[Default value]<br>General |
| Display Alarm Area  | N/A                               | [Setting method]<br>Enable or disable<br>[Default value]                                      |
| Area Alarm Interval | N/A                               | [Setting method]<br>Enter a value manually ranges from 1 to 1800.<br>[Default value]<br>10    |

Figure 6-51 Advanced parameter

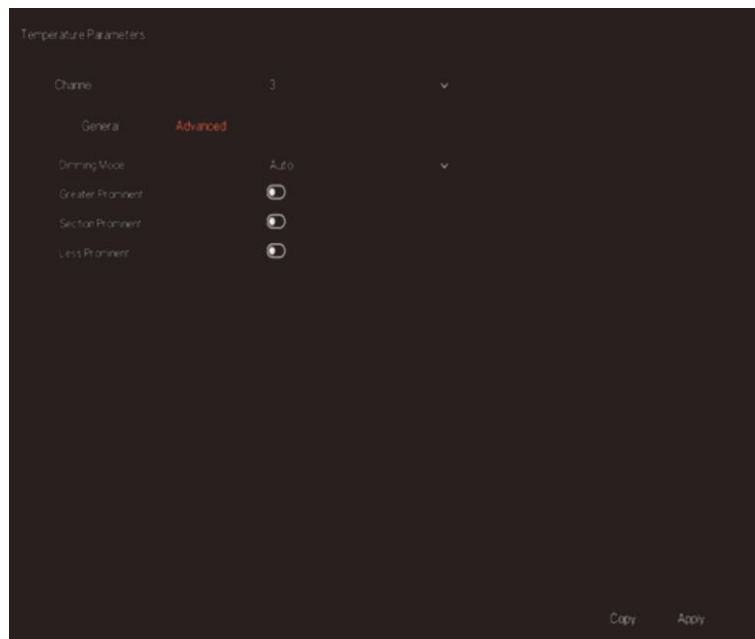


Table 6-2 Advanced parameters

| Parameter         | Description   | Setting  |
|-------------------|---|--|
| Dimming Mode      | There are auto and manual modes. It will show on temperature item.  | [Setting method]<br>Select a value from the drop-down list box.<br>[Default value]<br>Auto |
| Greater Prominent | Enable that, the image will show the setting color if the temperature is higher than set value.                   | [Setting method]<br>Enter a value manually.<br>Choose one color to show.                   |
| Section Prominent | Enable that, the image will show the setting color if the temperature is between minimum and maximum temperature. | [Setting method]<br>Enter a value manually.<br>Choose one color to show.                   |
| Less Prominent    | Enable that, the image will show the setting color if the temperature is lower than set value.                    | [Setting method]<br>Enter a value manually.<br>Choose one color to show.                   |

Step 3 Click **Copy** to copy the same settings to others thermal cameras.

Step 4 Click **Apply**.

Step 5 The message "Apply success" is displayed, the system saves the settings.

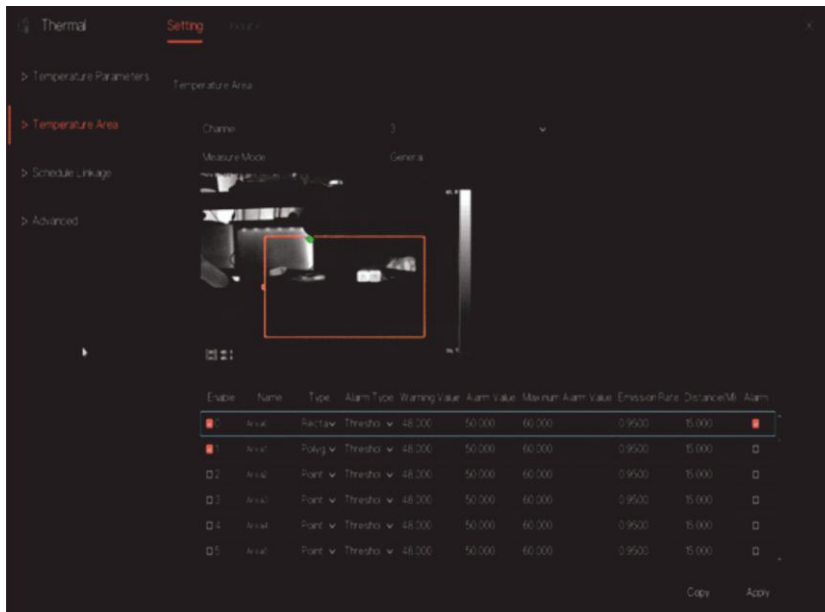
## 6.6.2 Temperature Area

### Operation Procedure

Step 1 Choose Thermal > Temperature Area

The **Temperature Area** page is displayed, as shown in Figure 6-52


Table 6-52 Temperature area and alarm configuration



Step 2 Set the parameters according to Table 6-3

Table 6-3 Temperature area and alarm configuration

| Parameter                          | Description   | Setting   |
|------------------------------------|---|---|
| Channel                            | N/A   | [Setting method]<br>Select a value from the drop-down list box.<br>[Default value]<br>1 |
| Measure Mode                       | Set at temperature parameter interface  | N/A   |
| PTZ Area(only use for PTZ cameras) | Choose or set the preset, adjust the camera with PTZ keyboard.<br>The all presets can set 20 areas to alarm | Set the preset manually, or select an existing preset in the drop-down list.            |
| Enable                             | Tick to enable alarm areas.   | N/A   |
| ID                                 | It ranges from 0 to 19.   | N/A   |

| Parameter           | Description   | Setting   |
|---------------------|---|---|
| Name                | Area name of temperature area.  | [Setting method]<br>Enter a value manually.   |
| Type                | Type of temperature area.<br>ID 0 is default rectangle area, which is full screen.<br>There are 20 areas can be set, these are from 0 to 19 area.       | [Setting method]<br>Select a value from the drop-down list box.<br>[Default value]<br>Rectangle/Point   |
| Alarm Type          | Threshold alarm and Temperature difference alarm are available for alarm type.  | [Setting method]<br>Select a value from the drop-down list box.<br>[Default value]<br>Threshold alarm   |
| Warning Value       | Camera will warn when the surveillance object temperature reaches the warning value   | [Setting method]<br>Enter a value manually.<br>[Default value]<br>48.00   |
| Alarm Value         | Camera will alarm when the surveillance object temperature reaches the alarm value.   | [Setting method]<br>Enter a value manually.<br>[Default value]<br>50.00   |
| Maximum Alarm Value | The maximum value of the alarm range, if the alarm value is exceeded, no alarm will be generated.   | [Setting method]<br>Enter a value manually.<br>[Default value] 60.00  |
| Emission Rate       | The emission rate is the capability of an object to emit or absorb energy.<br>The emission rate should be set only when the target is special material. | [Setting method]<br>Enter a value manually.<br>[Default value]<br>0.95  |
| Distance(M)         | The distance between camera and target.   | [Setting method]<br>Enter a value manually.<br>[Default value] 15<br><br> <b>NOTE</b><br>Enter actual distance when the distance between camera and target is less than 15 m.<br>Enter 15 when the distance between camera and target is great than or equal to 15 m |
| Alarm               | Open or close the alarm output and linkage of area.   | [Setting method]<br>Tick the alarm areas  |

### Step 3 Set temperature area

1. Tick an area ID.
2. Select type from drop-list.
3. Press and hold the left mouse button, and drag in the video area to draw a temperature area. Right-click to finish the area selected.
4. Click **Apply**, the message "Apply success" is displayed, the temperature area is set successfully.

Delete a temperature area:

1. Select an area ID.
2. Click the temperature area and right-click.
3. Remove the tick of area ID.
4. Click **Apply**, the message "Apply success" is displayed, the temperature area is deleted successfully.

Step 4 Click Apply.

Step 5 The message "Apply success" is displayed, the system saves the settings.

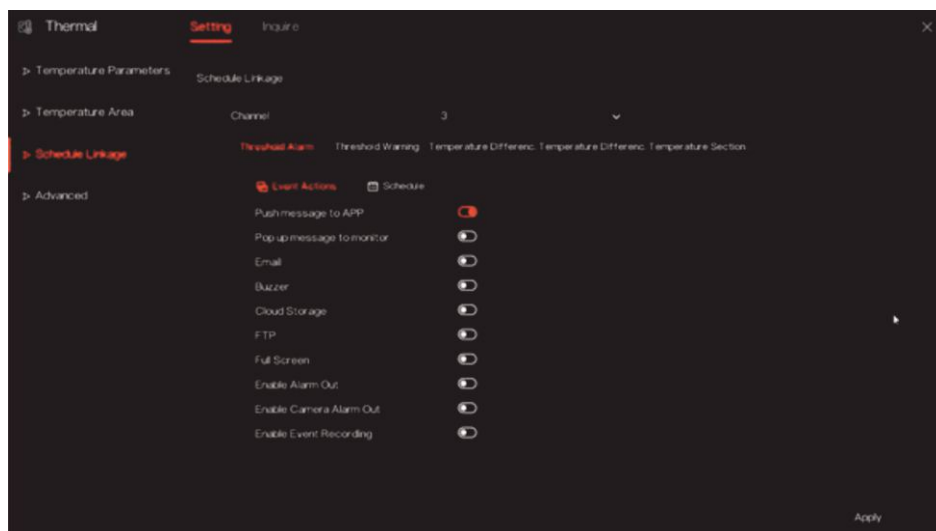
## 6.6.3 Schedule Linkage

Operation Procedure

Step 1 Choose Thermal > Schedule Linkage

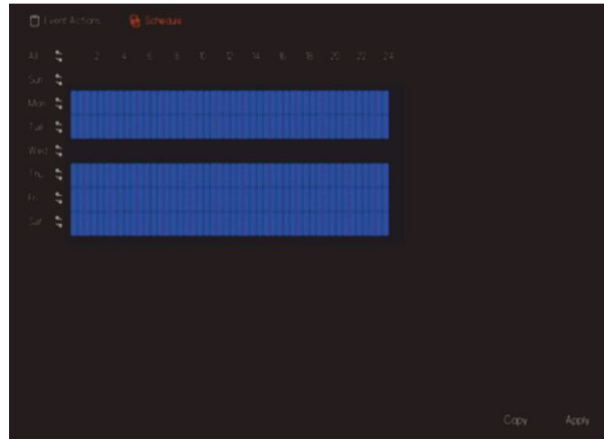
The **Schedule Linkage** page is displayed, as shown in Figure 6-53

Figure 6-53 Schedule Linkage



- Step 2 Tick the output channel.
- Step 3 Enable "Alarm Record", "E-mail" button.
- Step 4 Set schedule linkage.

Figure 6-54 Schedule



**Method 1:** Click left mouse button to select any time point within 0:00-24:00 from Monday to Sunday as shown in Figure 6-53

**Method 2:** Hold down the left mouse button, drag and release mouse to select the alarm time within 0:00-24:00 from Sunday to Saturday.

 **NOTE**

When you select time by dragging the cursor, the cursor cannot be moved out of the time area. Otherwise, no time can be selected.

**Method 3:** Click  in the alarm time page to select the whole day or whole week.

**Deleting alarm time:** : Click  again or inverse selection to delete the selected alarm time.

Step 5 Click **Apply**.

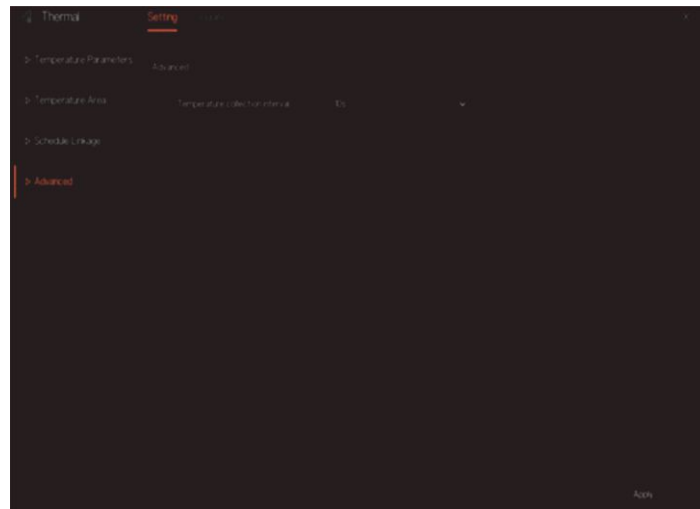
Step 6 The message "Apply success" is displayed, the system saves the settings.

## 6.6.4 Advanced

Step 1 Choose **Thermal > Advanced** to enter the advance interface, as shown in .Figure 6-55



Figure 6-55 Advanced



- Step 2 Select the temperature collection interval from the drop-list.
- Step 3 Click **Apply**.
- Step 4 The message "Apply success" is displayed, the system saves the settings.

## 6.6.5 Inquire

### Operation Procedure

- Step 1 Choose **Thermal** > **Inquire** to enter the inquire interface, as shown in Figure 6-56

Figure 6-56 Inquire



- Step 2 Choose the channel is thermal camera.
- Step 3 Set the start and end time.
- Step 4 Choose the area, which is set at the temperature area interface. The default area is 0(full screen).
- Step 5 Choose the type of temperature, set the temperature range.
- Step 6 Choose the interval of showing, click Search to show the result, there are two modes to show result, list or picture.

## 6.7 Channel Information


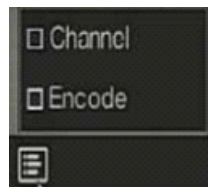
Click the  will show as Figure 6-57 , tick the Channel or Encode, the information will show in live video screen.

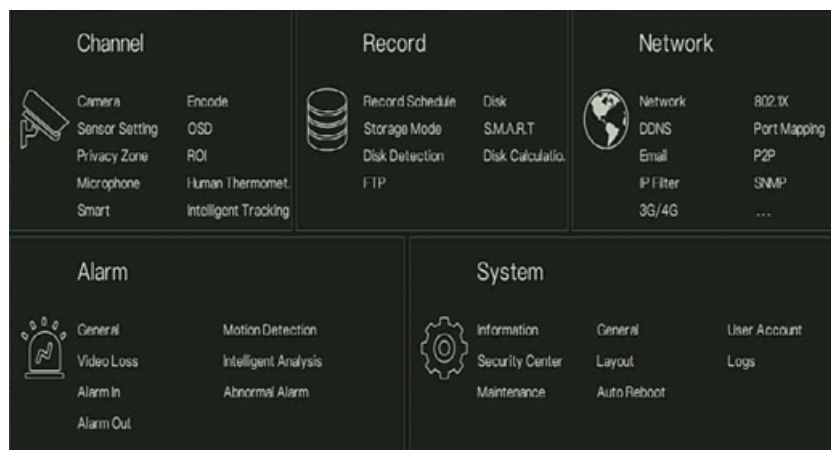
Figure 6-57 Channel information



## 6.8 Main Menu

Right-click on UI screen, the main menu as shown in Figure 6-58 The main menu includes **Channel**, **Record**, **Network**, **Alarm** and **System**.

Figure 6-58 Channel information



## 7.UI System Setting

### NOTE

Different devices may have different functions, please refer to actual product.

### 7.1 Channel Management

IP cameras can directly connect to input channels of the NVR by plugging in PoE port. When IP cameras are insufficient, the NVR can automatically search for and adds IP cameras or manually add cameras in the same Local Area Network (LAN).

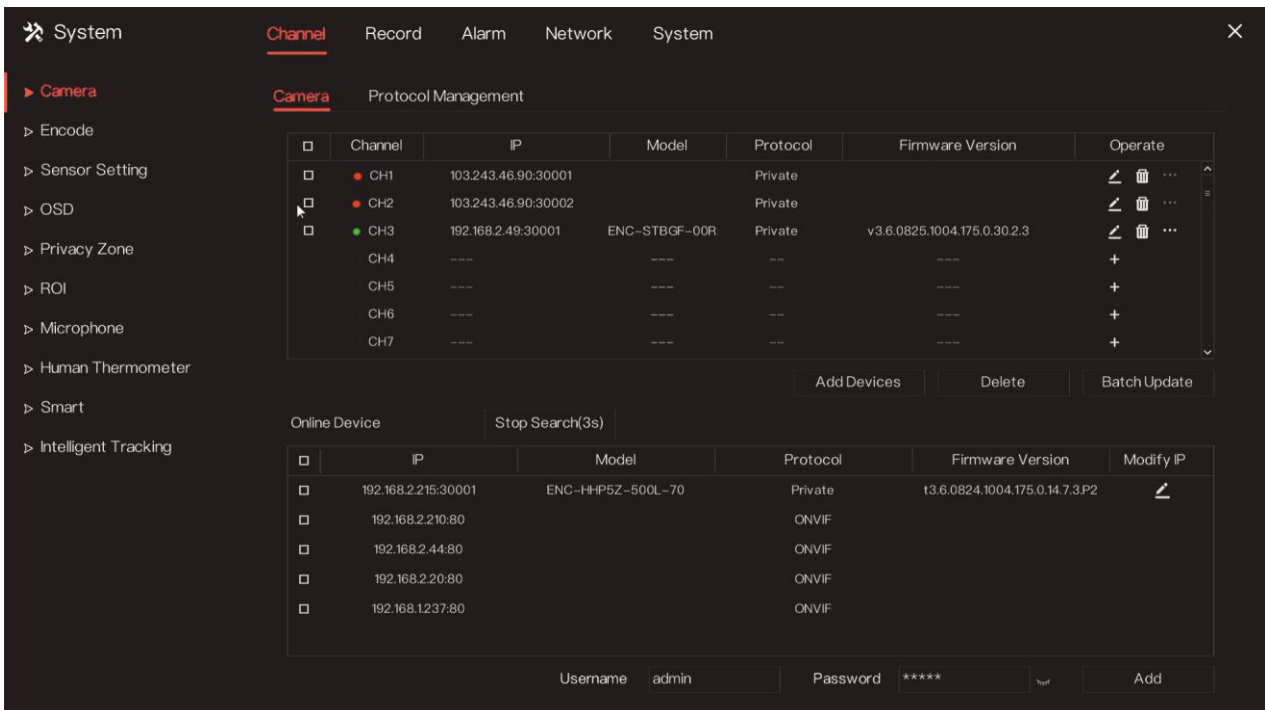
Channel management includes add or delete **Camera, Encode, Sensor Setting, OSD, Privacy Zone, ROI, Microphone, Human Thermometer, Smart, and Intelligent Tracking.**

#### 7.1.1 Camera

##### Operation Description

Click **Channel** in the main menu to access the camera management screen, as shown in Figure 7-1. there are four modes to add cameras, add manually, add by batch, add by PoE, add automatically.

Figure 7-1 Channel management screen



The screenshot shows the 'Channel' management interface. The top navigation bar includes 'System', 'Channel', 'Record', 'Alarm', 'Network', and 'System'. The left sidebar menu includes 'Camera', 'Encode', 'Sensor Setting', 'OSD', 'Privacy Zone', 'ROI', 'Microphone', 'Human Thermometer', 'Smart', and 'Intelligent Tracking'. The main content area is titled 'Camera Protocol Management' and contains a table of channels and an 'Online Device' section.

| Channel | IP                  | Model         | Protocol | Firmware Version            | Operate |
|---------|---------------------|---------------|----------|-----------------------------|---------|
| CH1     | 103.243.46.90:30001 |               | Private  |                             | ⏏️ 🗑️ ⋮ |
| CH2     | 103.243.46.90:30002 |               | Private  |                             | ⏏️ 🗑️ ⋮ |
| CH3     | 192.168.2.49:30001  | ENC-STBGF-00R | Private  | v3.6.0825.1004.175.0.30.2.3 | ⏏️ 🗑️ ⋮ |
| CH4     | ---                 | ---           | --       | ---                         | +       |
| CH5     | ---                 | ---           | --       | ---                         | +       |
| CH6     | ---                 | ---           | --       | ---                         | +       |
| CH7     | ---                 | ---           | --       | ---                         | +       |

Buttons: Add Devices, Delete, Batch Update

Online Device: Stop Search(3s)

| IP                  | Model             | Protocol | Firmware Version               | Modify IP |
|---------------------|-------------------|----------|--------------------------------|-----------|
| 192.168.2.215:30001 | ENC-HHP5Z-500L-70 | Private  | t3.6.0824.1004.175.0.14.7.3.P2 | ⏏️        |
| 192.168.2.210:80    |                   | ONVIF    |                                |           |
| 192.168.2.44:80     |                   | ONVIF    |                                |           |
| 192.168.2.20:80     |                   | ONVIF    |                                |           |
| 192.168.1.237:80    |                   | ONVIF    |                                |           |

Username: admin Password: \*\*\*\*\* Add

### 7.1.1.1 Add Camera Automatically



The NVR can add automatically cameras to the camera list.

#### Operation Methods

Method 1: Click **Start Search** button, the cameras these are the same local subnet with NVR will show in list, the search will be lasting for 20 seconds. Input username and password (the default value both are admin) click **Add Devices** the cameras in the list would be added to channels

Method 2: Select the cameras you wanted to add, and click **Add** the selected cameras would be added to the camera list. Tick the online non-onvif channels at list and click **Batch Update** to access the directory of software; it would to update the channels at once.

#### NOTE

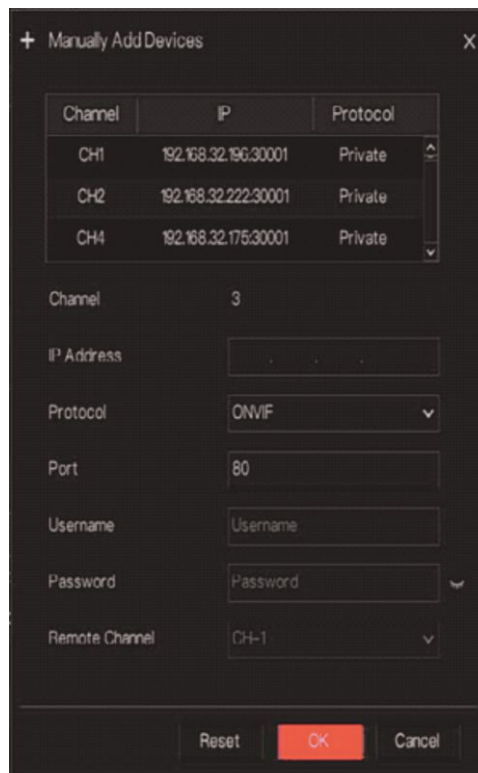
- On the camera management screen, check the status of channel in the camera list. If the status of a channel is , this camera is online. If the status of a channel is , this camera is offline.
- The added cameras should be the same subnet segment as NVR.

### 7.1.1.2 Add Camera Automatically

#### Operation Steps

Step 1 Click , the screen to add devices manually is displaying, as shown in Figure 7-2

Figure 7-2 Add camera screen



| Channel | IP                   | Protocol |
|---------|----------------------|----------|
| CH1     | 192.168.32.196.30001 | Private  |
| CH2     | 192.168.32.222.30001 | Private  |
| CH4     | 192.168.32.175.30001 | Private  |

Channel: 3

IP Address:

Protocol: ONVIF

Port: 80

Username:

Password:

Remote Channel: CH-1

Reset OK Cancel

Step 2 Input IP address, port, user name and password of camera. If the user want to add the same camera's second channel who can double click the online camera IP, so that the information will be copied to the below, user modify the remote channel to add quickly.

Step 3 Select a protocol from the drop-down list(ONVIF, Private, custom protocols). Remote channel is only used for multi channels cameras, such as human temperature cameras, fisheye cameras, and so on.

Step 4 Click **OK** , the camera is added successfully.

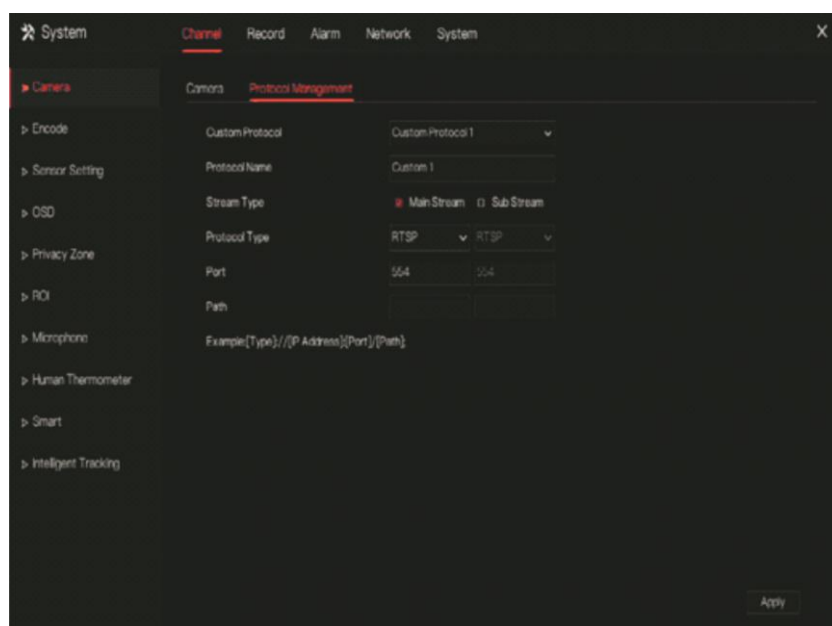
## NOTE

If all channels of the NVR are connected by cameras, please delete the cameras that you don't need , so that you can add more cameras. If an IP camera is added manually, input the correct username and password of the camera below the online device list. The camera will be added successfully. If not the camera would be shown on list at offline. The protocol can be chosen the custom protocols these are set at protocol interface. The user can click the added channel to copy the information to save the time, you can just need to modify difference information, such as the remote channel.

### 7.1.1.3 Add Camera by RSTP

If the user wants to add the different protocol cameras to NVR, you can set the protocol management, and add cameras one by one, as shown in Figure 7-3

Figure 7-3 Protocol management



Step 1 Click **Channel > Camera > Protocol Management**.

Step 2 Choose the custom protocol from the drop-down list, there are 16 kinds of protocols can be set.

Step 3 Input the protocol name.

Step 4 Tick main stream and sub stream. The main stream shows image on full screen live video. The sub stream shows image on split screen. If you just tick main stream and the channel will not show image on split screen.

Step 5 Choose the type of protocol, the default value is RTSP.

Step 6 Input the port, it depends the IP camera.

Step 7 Input the path, it depends the manufacturer of cameras.

Step 8 Click Apply to save the settings.

 **NOTE**

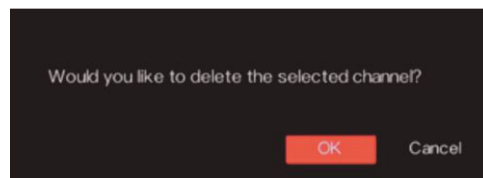
Choose the protocol from the drop-down list, the protocol is set at protocol management interface. The cameras should be confirmed to the protocols.


#### 7.1.1.4 Delete Camera

##### Operation Steps

Step 1 Select a camera to delete in the camera list and click  ,the delete confirmation message screen is displaying, as shown in Figure 7-1

Figure 7-4 Delete confirmation message

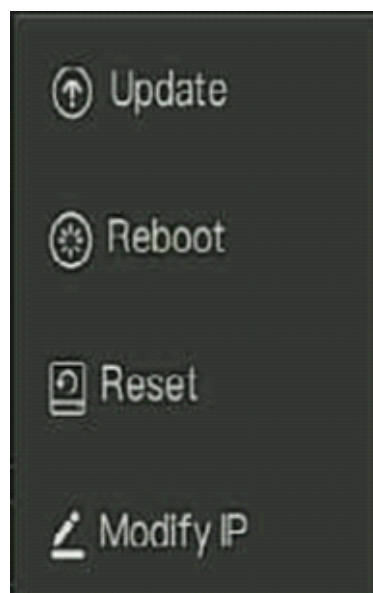


Step 1 Click  ,the camera will be deleted successfully.

#### 7.1.1.5 Operate Camera

At camera list, click  , To operate camera as shown in Figure 7-5 , user can update, reboot and reset the camera immediately.

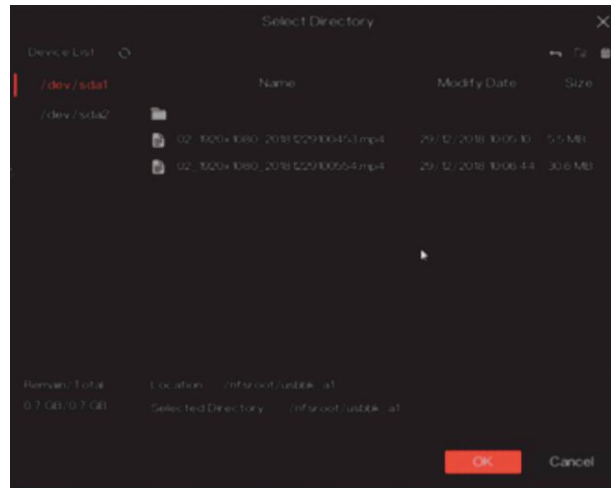
Figure 7-5 More operation




Step 1 Click **Update**, pop-up window to select software, as shown in Figure 7-5

Step 2 Set the directory click  , to update camera.

Figure 7-6 Select directory of software



Step 3 Click **Reboot**, message “**Are you sure to reboot?**” would show, click  to reboot the camera.

Step 4 Click **Reset**, message “**Are you sure to reset?**” would show, user can enable the retain IP address function. click  to reset the camera.

Step 5 Tick the cameras with non-onvif protocol and cameras are online, click **Update** to update all cameras at once.

Step 6 The online camera can be modified the IP, click **Modify IP** to modify as shown in following figure, input the new IP address and subnet mask.

## NOTE

Update need upload the firmware by flash driver.

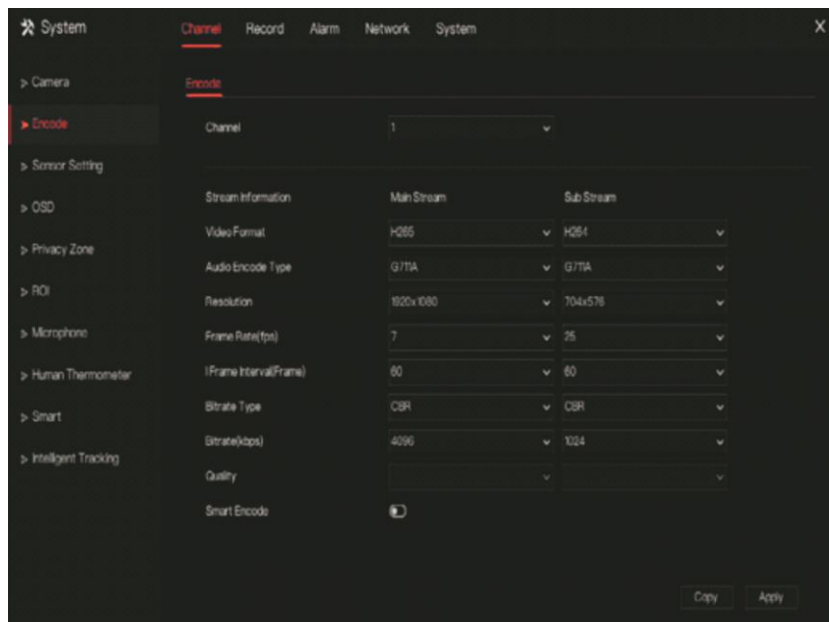
### 7.1.2 Encode Parameter

The system allows setting the stream information, encoding type, resolution, frame rate, bitrate control, bitrate and quality for cameras in a channel in **Encode Parameter** screen.

#### Operation Description

Click **Encode** in the main menu or **Menu** of the channel management screen and choose **Encode** to access the **Encode** screen, as shown in . Figure 7-7

Figure 7-7 Encode Screen



#### Operation Steps

Step 1 Select a channel from the drop-down list of channel.

Step 2 Set video format, audio encode type, resolution, frame rate, bitrate type, bitrate size and quality from the drop-down lists.

Step 3 Click **Copy** and select channels or tick all, then click **OK** to apply the parameter settings to cameras in selected channels, click **Apply** to save encode parameter settings.

### 7.1.3 Sensor Setting

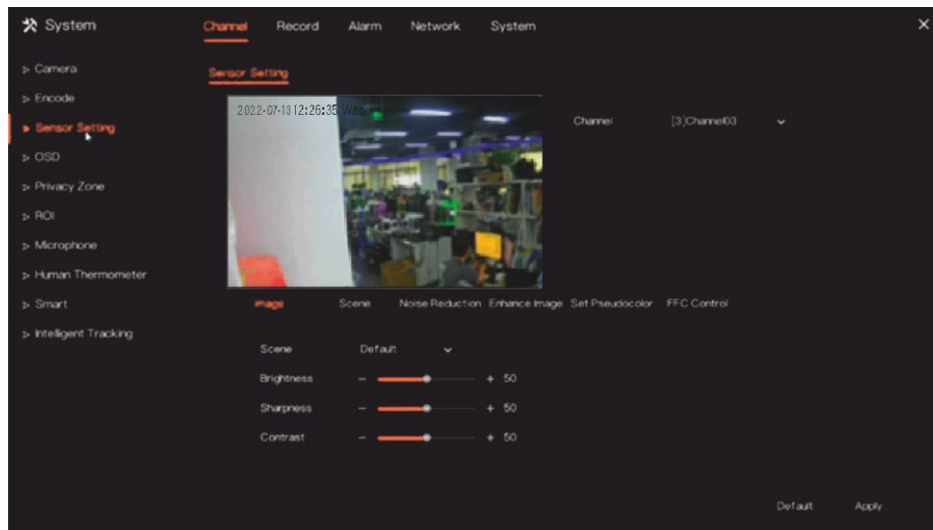
Sensor setting refer to basic attributes of pictures, it includes the brightness, sharpness, contrast and saturation. You can set picture parameters for each channel based on scene.

#### Operation Description

Click **Sensor Setting** in the main menu or click menu of the channel management screen and choose **Sensor Setting** to access the Sensor Setting screen, as shown in Figure 7-8



Figure 7-8 Sensor setting screen



The Sensor Setting are as follows:

- Brightness: it indicates brightness or darkness of picture.
- Sharpness: it indicates picture's clarity.
- Contrast: it refers to the brightest white and darkest black in an image.
- Saturation: it indicates brilliance of the picture color.
- 

Other parameters are sensor settings of IP cameras, like scene, exposure, white balance, day-night, noise reduction, enhance image, zoom focus, etc.

- Scene: it includes indoor, outdoor, default. Mirror includes normal, horizontal, vertical, horizontal + vertical.
- Exposure: it includes mode, max shutter, meter area and max gain.
- White balance: it includes tungsten, fluorescent, daylight, shadow, manual, etc.
- Day-night: user can transit day to night, or switch mode.
- Noise reduction: it includes 2D NR and 3D NR.
- Enhance image: it includes WDR, HLC, BLC, defog and anti-shake.
- Zoom focus: user can zoom and focus.

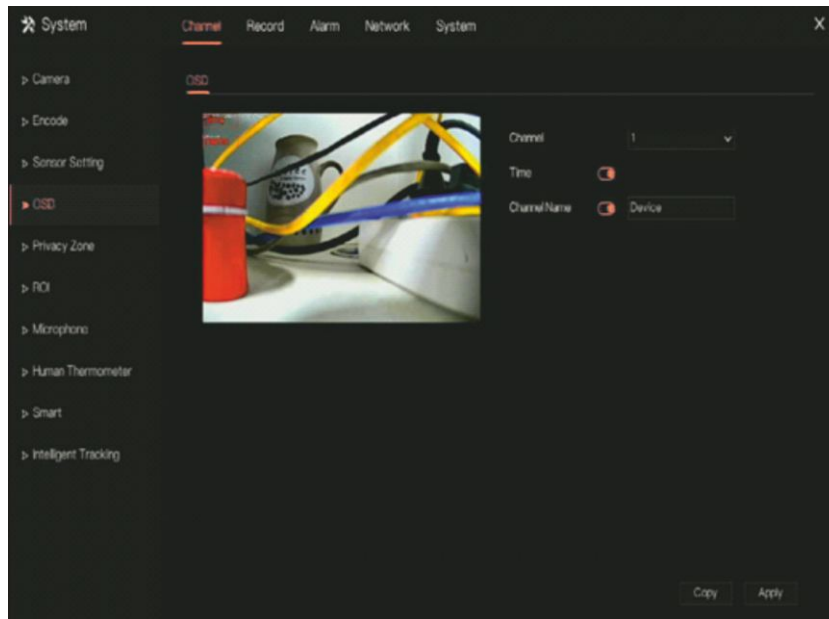
### Operation Steps

- Step 1 Select a channel from the drop-down list of channel.
- Step 2 Select scene from the drop-down list. The default values of picture parameters vary with scenarios.
- Step 3 Set parameters.
- Step 4 Click **Default** to reset to factory settings, click **Apply** to save image settings.






## 7.1.4 OSD Settings

Click **OSD** in the main menu or menu of the channel management screen and choose **OSD** to access the OSD screen, as shown in Figure 7-9

Figure 7-9 OSD setting screen



### Operation Steps

- Step 1 Select a channel from the drop-down list of channel.
- Step 2 Click  next to Time to enable or disable OSD time setting.
- Step 3 Click  next to Name to enable or disable OSD channel setting.
- Step 4 Set the channel name.
- Step 5 In the video window, click and drag time or channel to move to a location.
- Step 6 Click  and select channels, then click  to apply the OSD settings to cameras in selected channels ,  
Click  to save OSD settings.

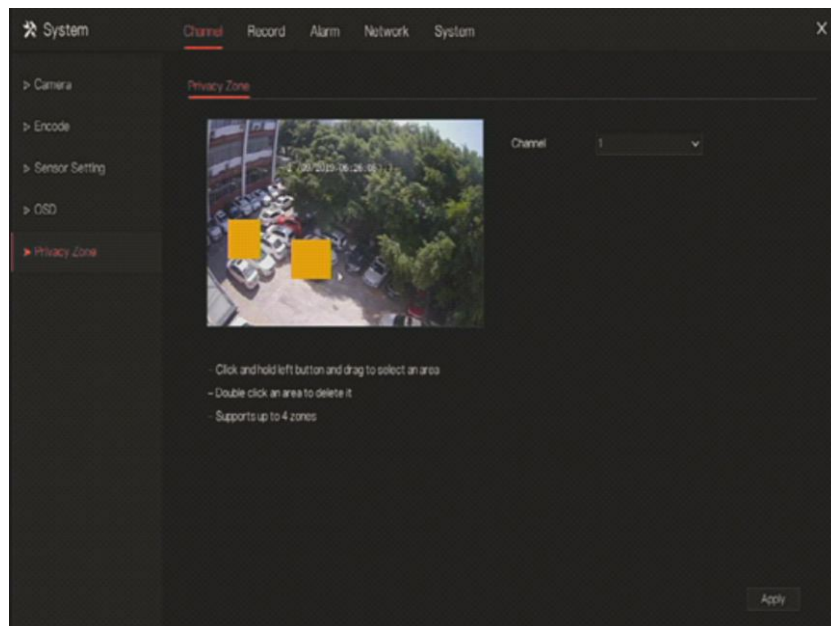
## 7.1.5 Privacy Zone

The system allows you to mask images in a specified zone and this zone is called privacy zone.

### Operation Description

Click **Privacy Zone** in the main menu or menu of the channel management screen and choose **privacy zone** to access the Privacy Zone screen, as shown in Figure 7-10.

Figure 7-10 Privacy zone screen



### Operation Steps

- Step 1 Select a channel from the drop-down list of channel.
- Step 2 In the video window, hold down and drag the left mouse button to draw a privacy area.
- Step 3 Click **Copy** and select channels or tick **all**, then click **OK** to apply the privacy settings to cameras in selected channels, click **Apply** to save privacy settings.
- Step 4 Double click privacy area to delete setting.

## 7.1.6 ROI

Click **ROI** in the main menu or menu of the channel management screen and choose **ROI** to access the ROI screen, as shown in Figure 7.11

Figure 7-11 ROI

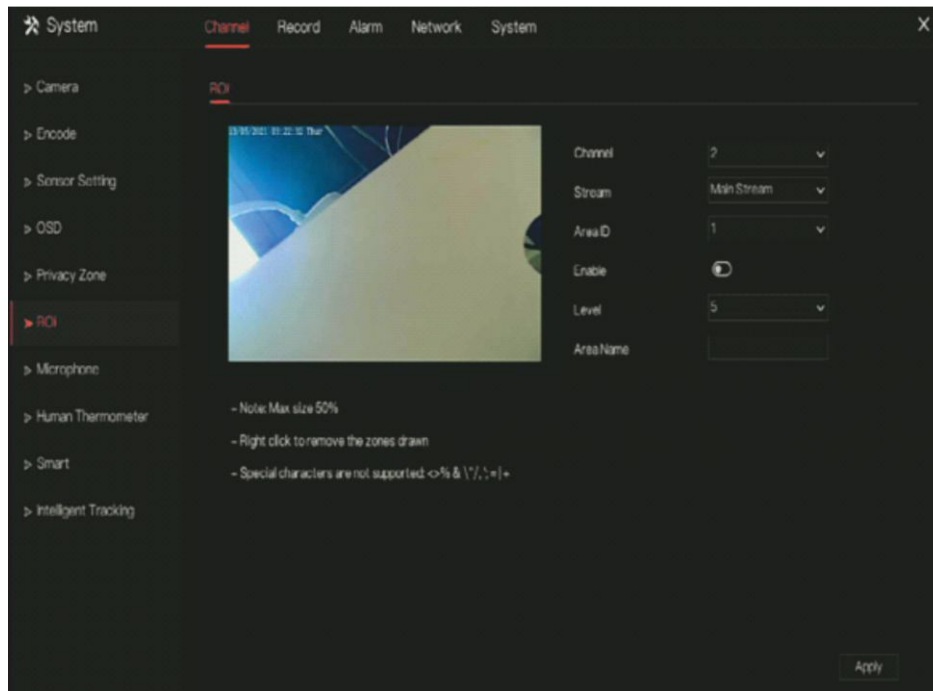


Table 7-1 ROI Parameter

| Parameter | Description   | Setting  |
|-----------|---|--|
| Stream    | Stream ID.  | [Setting method]<br>Select a value from the drop-down list box.<br>[Default value]<br>Stream 1 |
| Enable    | Enable the ROI  | [Setting method]<br>Click the button.<br>[Default value]<br>OFF                                |
| Area ID   | ROI area ID, there are 8 area   | [Setting method]<br>Select a value from the drop-down list box.<br>[Default value] 1           |
| Level     | Visual effect of ROI. The higher the grade is, the more clearly areas inside and the vaguer areas outside are. There are five levels. | [Setting method]<br>Select a value from the drop-down list box.<br>[Default value] 5           |

| Parameter | Description                     | Setting   |
|-----------|---------------------------------|---|
| Area Name | The marked name used for areas. | [Setting method]<br>Enter a value manually. The value cannot exceed 32 bytes. |

### 7.1.7 Microphone (Only for Some Models)

Click **Microphone** in the main menu or menu of the channel management screen and choose Microphone to access the **Microphone** screen, as shown in Figure 7-12

Figure 7-12 Microphone

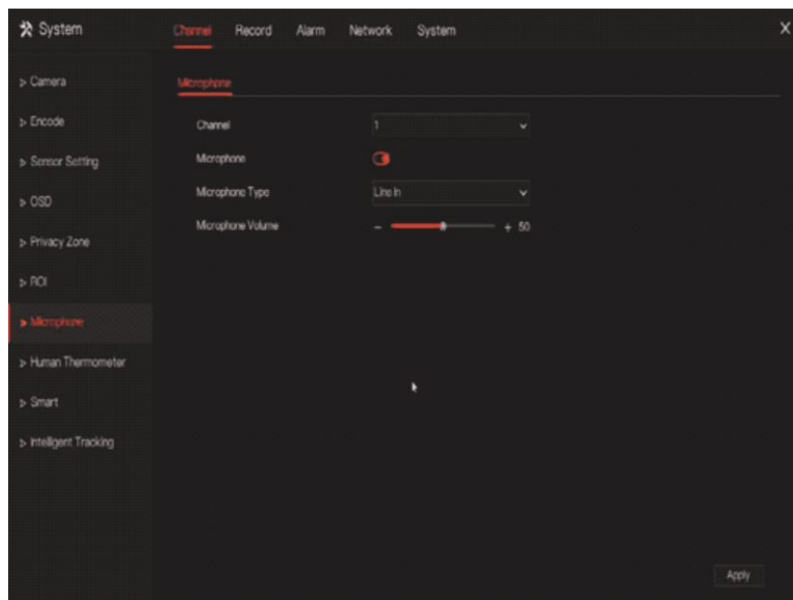


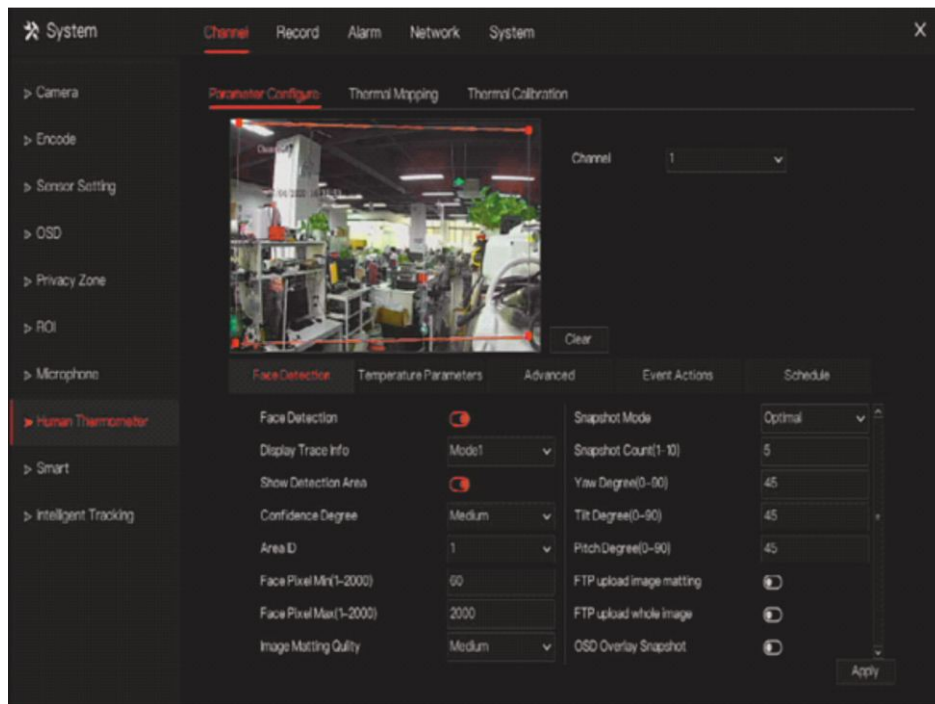
Table 7-12 Microphone

| Parameter         | Description  | Setting   |
|-------------------|--|---|
| Enable Microphone | Indicates whether to enable the microphone function.                         | [Setting method]<br>Click the button on to enable microphone.   |
| Microphone Type   | Microphone types include:<br>• Line In<br>An active audio input is required. | [Setting method]<br>Select a value from the drop-down list box.   |
| Microphone Volume | Allows you to adjust the microphone volume.                                  | [Setting method]<br>Slide the slider left or right.[Default value]<br>50<br>NOTE<br>The value ranges from 0 to 100. |

## 7.1.8 Human Thermometer (Only for Some Models)


Click **Human thermometer** in the main menu or menu of the channel management screen and choose **Human thermometer** to access the **Human thermometer** screen, as shown in

Figure 7-13 Human Thermometer



### 7.1.8.1 Parameter Configuration

Table 7-3 Human Thermometer

| Parameter      | Description   | Setting  |
|----------------|---|--|
| Face detection | Detect face of human  | [Setting method]<br>Enable<br>[Default value]<br>On                |
| Display trace  | Display the information of tracing.<br>Mode 1 :  | [Setting method]<br>Enable the button<br>[Default value]<br>Mode 1 |

| Parameter               | Description  | Setting  |
|-------------------------|--|--|
| Show detection area     | Enable, the live video will show area of detection.  | [Setting method]<br>Enable   |
| Show detection area     | Face detection sensitivity, the value range is high, medium, low, the larger the value is, the higher the sensitivity. The higher the sensitivity value is, the higher the detection rate will be, but the more false detection may occur, such as the false detection of the patterns on pedestrian clothes to adult faces. | [Setting method]<br>Choose from drop -list<br>[Default value]<br>Medium    |
| Area ID                 | There are 8 areas can be set to detect temperature. Choose from the drop-list, left-click to draw the area, right-click to finish the set.   | [Setting method]<br>Choose from drop -list<br>[Default value]<br>1         |
| Face pixel min (1-2000) | When the pixel of the face in the image is less than the set value (the minimum pixel for face recognition), it is not captured.   | [Setting method]<br>Input a number from 1 to 2000<br>[Default value]<br>30 |
| Face pixel max (1-2000) | When the pixel of the face in the image is more than the set value (the maximum pixel for face recognition), it is not captured.   | [Setting method]<br>Input a number from 1 to 2000<br>[Default value]<br>70 |
| Image matting quality   | The quality of snap image, There are three mode can be chosen, such as low, mid and high.  | [Setting method]<br>Choose from drop list.<br>[Default value]<br>Medium    |
| Snapshot mode           | There are two types, timing and optimal  | [Setting method]<br>Choose from drop -list<br>[Default value]<br>Timing    |
| Upload image interval   | The snapshot mode is optimal, set the interval.  | [Setting method]<br>Input a number from 1 to 10<br>[Default value]<br>5    |
| Snapshot count          | At optimal mode, set the number of snapshot image  | [Setting method]<br>Input 1  |

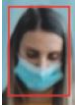
|                          |   |  |
|--------------------------|---|--|
| Yaw degree(0-90)         | Both eyes appear on the screen, offset in the left and right direction  | [Setting method]<br>Input a number from 0 to 90<br>[Default value]<br>30 |
| Tilt degree(0-90)        | The face is deflected, and both eyes cannot appear in the picture.  | [Setting method]<br>Input a number from 0 to 90<br>[Default value]<br>30 |
| Pitch degree(0-90)       | Face is moving up and down  | [Setting method]<br>Input a number from 0 to 90<br>[Default value]<br>30 |
| FTP upload image matting | <b>Configuration &gt; Network Service &gt; FTP</b> , set FTP related parameters, the captured picture will be sent to the set FTP location                    | [Default value]<br>Disable   |
| OSD over snapshot        | Enable, the snapshots will record the temperature, as shown in figure.<br> | [Default value]<br>Disable   |

Figure 7-14 Temperature parameters

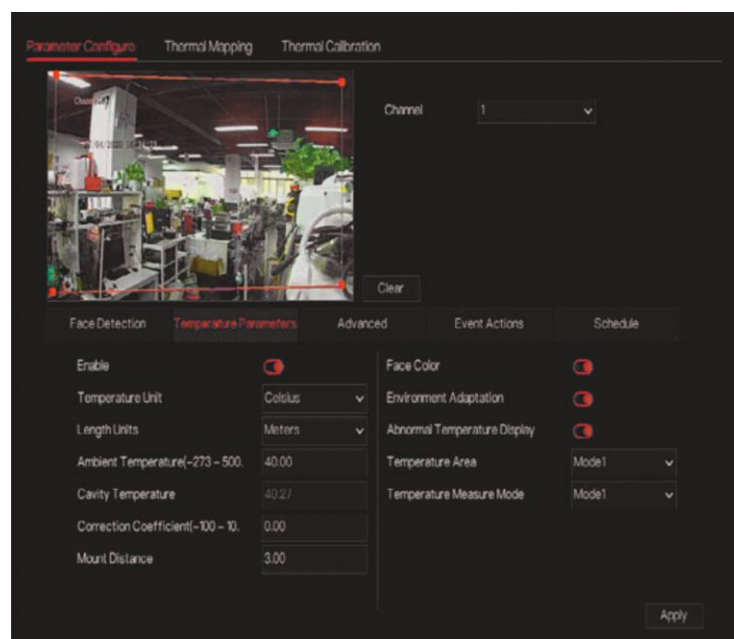





Table 7-4 Temperature parameters

| Parameter              | Description  | Setting   |
|------------------------|--|---|
| Temperature Unit       | Celsius and Fahrenheit temperature units are available.<br>The unit is link to all temperature parameter, please modify the linkage value.   | [Setting method]<br>Select a value from the drop-down list box.<br>[Default value]<br>Celsius |
| Ambient Temperature    | The ambient temperature of camera.   | [Setting method]<br>Enter a value manually.   |
| Cavity Temperature     | The cavity temperature of camera.  | N/A   |
| Correction Coefficient | Correction coefficient refers to the deviation of measured object temperature and actual temperature.<br>For example:<br>1. The measured object temperature is 30, and actual temperature is 37, so the correction coefficient is 7.<br>2. The measured object temperature is 37, and actual temperature is 30, so the correction coefficient is -7. | [Setting method]<br>Enter a value manually.<br>[Default value]<br>0.00                        |
| Mount distance         | The actual distance between the detection person and the device, it is set to facilitate the temperature measurement accuracy.   | [Setting method]<br>Select a value from the drop-down list box.<br>[Default value]<br>General |
| Face color             | Enable, if the camera detect the face and the face will be covered color, normal is yellow, and high temperature is red, as shown in figure.<br>  | [Default value]<br>Disable  |
| Environment adaptation | Enable, the device will restart the temperature if the ambient temperature of camera varies greatly. It is recommended not to open.  | [Default value]<br>Disable  |

| Parameter                    | Description  | Setting  |
|------------------------------|--|--|
| Abnormal temperature display | Enable, the measure temperature is lower than 34 °C will show on OSD.<br>Disable, the measure temperature is lower than 34 °C will not show on OSD   | [Default value]<br>Disable   |
| Temperature area             | Two modes, shows at themal channel.<br>Mode 1 is full face area, mode 2 is forehead area.  | [Setting method]<br>Select a value from the drop-down list box.<br>[Default value]<br>Mode 1 |
| Temperature measure mode     | Two modes, mode 1 is suitable for high air temperature, if the forehead temperature is less than 31 °C, not to show as body temperature.<br>Mode 2 is suitable for low air temperature, if the forehead temperature is at 30-31 °C, so it will show as body temperature too. | [Setting method]<br>Select a value from the drop-down list box.<br>[Default value]<br>Mode 1 |

Table 7-5 Temperature parameters of linkage

| Parameter                | Description  | Setting  |
|--------------------------|--|--|
| Output channel           | Choose channels to output alarm  | [Setting method]<br>Tick the channels<br>[Default value]<br>Uncheck        |
| Alarm rules              | Set the maximum temperature greater than set value   | [Default value]<br>Maximum temperature greater than                        |
| Alarm Interval(1-1800 S) | N/A  | [Setting method]<br>Input a number from 1 to 1800<br>[Default value]<br>10 |
| Alarm record             | Enable, install the SD card, when there is an alarm, the camera will record the current video. | [Setting method]<br>Enable   |
| SMTP                     | Enable, when there is an alarm, the camera will send mail.                                     | [Setting method]<br>Enable   |
| FTP upload               | Enable, when there is an alarm, the camera will upload FTP.                                    | [Setting method]<br>Enable   |

## 7.1.8.2 Thermal Mapping

Figure 7-15 Thermal mapping

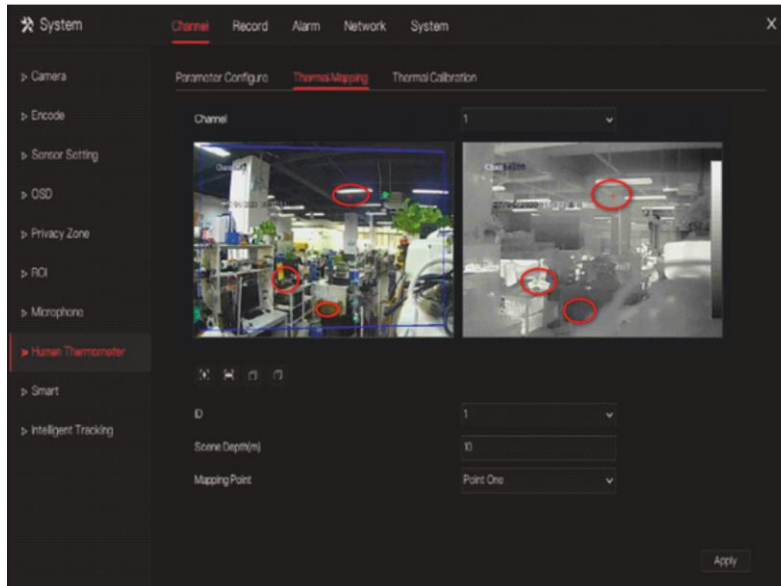




Table 7-6 Parameter of thermal mapping

| Parameter   | Description  | Setting  |
|---|--|--|
|  | Zoom in /zoom out.   | [Setting method]<br>Click the button             |
|  | Near focus / far focus.  | Output channel                                   |
| Lock focus position   | N/A  | [Setting method] Tick .                          |
| ID  | There are 8 scenes can be calibrated.  | [Setting method]<br>Select from drop-down list . |
| Scene depth(m)  | The distance of the clear image presented within the range before and after the focus.   | [Setting method]<br>Input value                  |
| Mapping point   | You need map three points at two channels. Points are correspond of each. The three points should cover most areas, and two points are located in the diagonal display of the picture.<br>Point one is green cross.<br>Point two is red cross.<br>Point three is blue cross. | [Setting method]<br>Select from drop list .      |

### 7.1.8.3 Thermal Calibration

Figure 7-16 Thermal calibration



Table 7-7 Thermal calibration

| Parameter                | Description  | Setting                         |
|--------------------------|--|---------------------------------|
| Display area information | Enable to show the information of displaying area.   | [Setting method]<br>enable      |
| Target temperature       | The special calibration tool's temperature, it is general black body's target temperature.         | [Setting method]<br>Input value |
| Emission rate            | Emission rate is the thermal calibration device's base parameter, the general blackbody's is 0.98. | [Setting method]<br>Input value |
| Distance                 | Distance is the actual horizontal distance between measuring object and the camera                 | [Setting method]<br>Input value |

## 7.1.9 Smart (Only for Some Models)

### NOTE

The comparison function is only for AI multiobject cameras, please refer to actual cameras.

### 7.1.9.1 AI Multiobject

Figure 7-17 AI multiobject

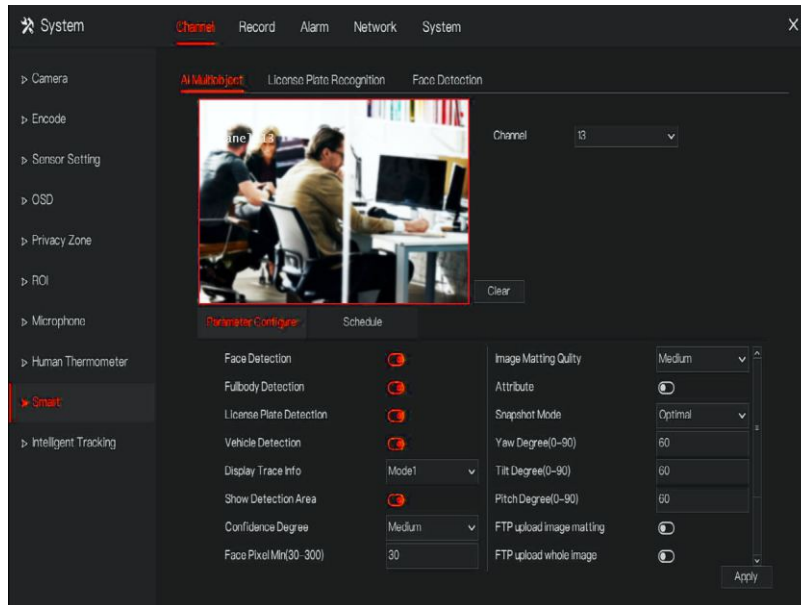




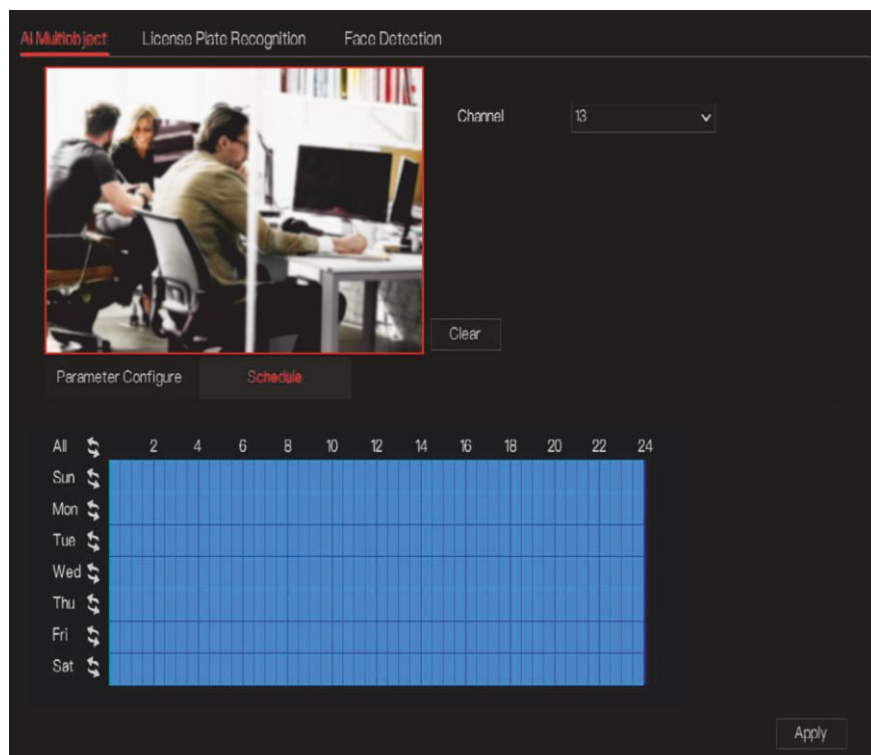
Table 7-8 AI multiobject

| Parameter               | Description   | Setting                |
|-------------------------|---|------------------------|
| Face detection          | The camera will snap the face when someone appears in live video.   | Enable                 |
| Full body detection     | The camera will snap the whole body when someone appears in live video.   | Enable                 |
| Licence plate detection | The camera will snap the licence when the vehicle's licence appears in live video.  | Enable                 |
| Vehicle detection       | The camera will snap the licence when the vehicle appears in live video.  | Enable                 |
| Display trace info      | Enable the function and a trace frame will show at live video.<br>Mode 1:  | Choose from drop list. |

| Parameter                     | Description   | Setting                        |
|-------------------------------|---|--------------------------------|
|                               | Mode 2:    |                                |
| Show detection area           | Enable to set a detection area, and the frame will show at live video   | Enable                         |
| Confidence coefficient        | The range of snap image, there are three type, such as high, mid and low. The higher the confidence, the better the snap quality and the fewer snapshots        | Choose from drop list          |
| Face pixel min(30-300)        | 30-300 pixels, the smaller the pixel be set, the more face will be captured, but it may be mistaken.  | Input a value ranges 30 to 300 |
| Body pixel min(30-300)        | 30-300 pixels, the smaller the pixel be set, the more body will be captured, but it may be mistaken.  | Input a value ranges 30 to 300 |
| Plate pixel min(30-300)       | 30-300 pixels, the smaller the pixel be set, the more face will be captured, but it may be mistaken.  | Input a value ranges 30 to 300 |
| Vehicle pixel min(30-300)     | 30-300 pixels, the smaller the pixel be set, the more face will be captured, but it may be mistaken   | Input a value ranges 30 to 300 |
| Image matting quality         | The quality of snap image, There are three mode can be chosen, such as low, mid and high.   | Choose from drop list.         |
| Attribute                     | Click to enable, the screenshot can display the relevant basic information of the vehicle. Such as the age of people, gender, etc. The color, model of the car. | Enable                         |
| Snapshot mode                 | There are three mode can be chosen, such as timing, and optimal.  | Choose from drop list          |
| Upload image interval(1-10 s) | At timing mode, set the interval of upload image.   | Input a value ranges 1 to 10   |
| Snapshot count                | At optimal mode, set the number of snapshot image   | Input a value ranges 1 to 5    |

| Parameter                | Description  | Setting                      |
|--------------------------|--|------------------------------|
| Yaw degree(0-90)         | Both eyes appear on the screen, offset in the left and right direction   | Input a value ranges 0 to 90 |
| Tilt degree(0-90)        | Both eyes appear on the screen, offset in the left and right direction   |                              |
| Pitch degree(0-90)       | Face is moving up and down   |                              |
| FTP upload image matting | <b>Configuration &gt; Network Service &gt; FTP</b> , set FTP related parameters, the captured picture will be sent to the set FTP location | Enable                       |
| FTP upload whole image   | Capture a picture and send a whole image.  | Enable                       |

Figure 7-18 Schedule



## 7.1.9.2 License Plate Recognition

Figure 7-19 License Plate Recognition

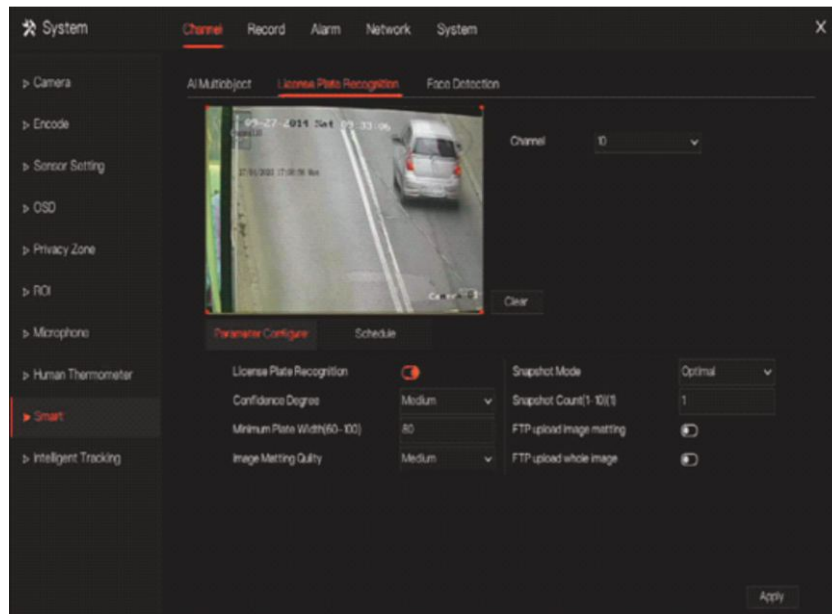


Table 7-9 License plate recognition

| Function                           | Procedure   | Description                    |
|------------------------------------|---|--------------------------------|
| Licence plate recognition          | The camera will snap the face when someone appears in live video.   | Enable                         |
| Confidence coefficient             | The range of snap image, there are three type, such as high, mid and low. The higher the confidence, the better the snap quality and the fewer snapshots. | Choose from drop-down list.    |
| Minimum plate width (60-100 Pixel) | 60-100 pixels, the smaller the pixel be set, the more plate will be captured, but it may be mistaken.   | Input a value ranges 60 to 100 |
| Image matting quality              | The quality of snap image, There are three mode can be chosen, such as low, mid and high.   | Choose from drop-down list.    |
| Snapshot mode                      | There are three mode can be chosen, such as timing, and optimal.  | Choose from drop-down list.    |



| Function                     | Procedure  | Description                  |
|------------------------------|--|------------------------------|
| Upload image interval(1-10 s | At timing mode, set the interval of upload image   | Input a value ranges 1 to 10 |
| Snapshot count (1)           | At optimal mode, set the number of snapshot image  | Input 1                      |
| FTP upload image matting     | <b>Configuration &gt; Network Service &gt; FTP</b> , set FTP related parameters, the captured picture will be sent to the set FTP location | Enable                       |
| FTP upload whole image       | Capture a picture and send a whole image.  | Enable                       |

### 7.1.9.3 Face Detection

Figure 7-20 Face detection

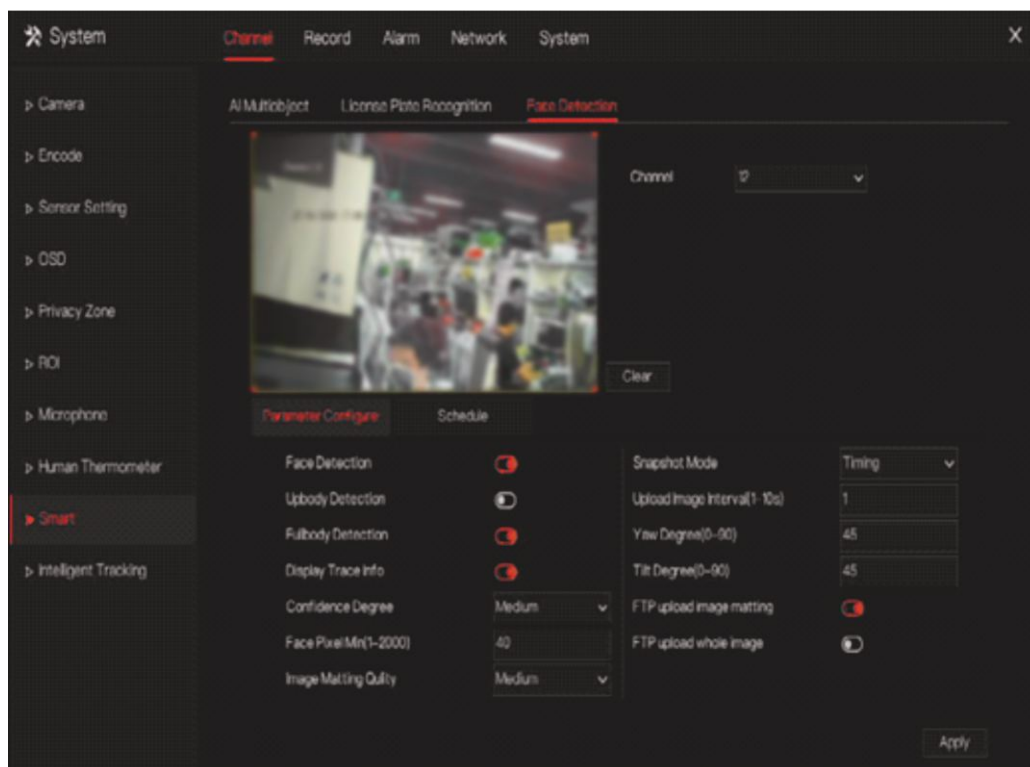


Table 7-10 Human face detection

| Parameter                          | Description  | Setting  |
|------------------------------------|--|--|
| Face detection                     | Detect face of human   | [Setting method]<br>Enable<br>[Default value]<br>On                            |
| Up body detection                  | Detect up body of human  | [Setting method]<br>Enable<br>[Default value]<br><b>OFF</b>                    |
| Full body detection                | Detect full body of human  | [Setting method]<br>Enable<br>[Default value]<br><b>OFF</b>                    |
| Display trace                      | Display the information of tracing.  | [Setting method]<br>Enable   |
| Confidence coefficient             | Face detection sensitivity, the value range is high, medium, low, the larger the value is, the higher the sensitivity. The higher the sensitivity value is, the higher the detection rate will be, but the more false detection may occur, such as the false detection of the patterns on pedestrian clothes to adult faces. | [Setting method]<br>Choose from drop -list<br>[Default value]<br><b>Medium</b> |
| Face pixel min (1-2000) snapshots. | When the pixel of the face in the image is less than the set value (the minimum pixel for face recognition), it is not captured.   | [Setting method]<br>Input a number from 1 to 2000<br>[Default value]<br>30     |
| Face pixel max (1-2000)            | When the pixel of the face in the image is more than the set value (the maximum pixel for face recognition), it is not captured.   | [Setting method]<br>Input a number from 1 to 2000<br>[Default value]<br>70     |
| Image matting quality              | The quality of snap image, There are three mode can be chosen, such as low, mid and high.  | [Setting method]<br>Choose from drop list.<br>[Default value]<br><b>Medium</b> |

| Parameter                | Description  | Setting  |
|--------------------------|--|--|
| Snapshot mode            | There are two types, timing and optimal.   | [Setting method]<br>Choose from drop -list<br>[Default value]<br>Timing  |
| Upload image interval    | The snapshot mode is optimal, set the interval.  | [Setting method]<br>Input a number from 1 to 10<br>[Default value]<br>5  |
| Snapshot count           | At optimal mode, set the number of snapshot image  | [Setting method]<br>Input 1  |
| Yaw degree(0-90)         | Both eyes appear on the screen, offset in the left and right direction   | [Setting method]<br>Input a number from 0 to 90<br>[Default value]<br>30 |
| Tilt degree(0-90)        | The face is deflected, and both eyes cannot appear in the picture.   | [Setting method]<br>Input a number from 0 to 90<br>[Default value]<br>30 |
| FTP upload image matting | <b>Configuration &gt; Network Service &gt; FTP</b> , set FTP related parameters, the captured picture will be sent to the set FTP location | [Default value]<br>Disable   |
| FTP upload whole image   | Capture a picture and send a whole image.  | [Default value]<br>Disable   |

### 7.1.10 Intelligent Tracking (Only for Some Models)

The automatic target tracking function is that the dome camera can continuously track the moving target of the pre-made scene, and automatically adjusts the camera zoom focus according to the moving target distance, and the dome automatically returns to the preset scene when the moving target disappears.

Figure 7-21 Intelligent tracking

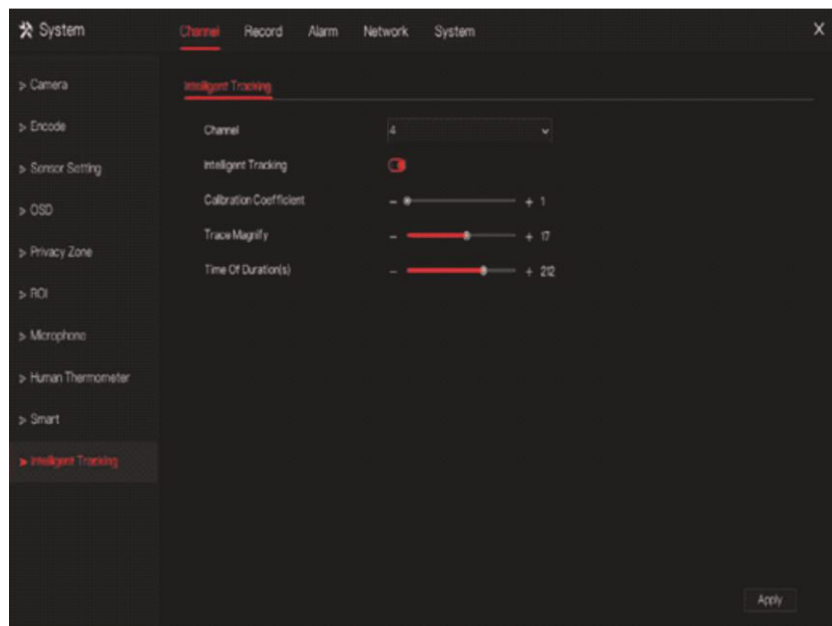


Table 7-10 Intelligent tracking parameters

| Parameter               | Description   | Setting   |
|-------------------------|---|---|
| Enable                  | Enable the button to enable the intelligent tracking  | [How to set]<br>Click Enable to enable.<br>[Default value]<br>OFF |
| Calibration Coefficient | It is equivalent to a control coefficient, and real-time tracking doubling rate nonlinear positive correlation, usually the higher the installation height, the greater the calibration coefficient value; it ranges from 1 to 30 | [Setting method]<br>Drag the slider.<br>[Default value]<br>1      |
| Trace Magnify           | It is the value of lens zoom, it has a large influence on the real-time tracking magnification,   | [Setting method]<br>Drag the slider.<br>[Default value]<br>7      |
| Time of Duration        | The maximum time of a tracking period, it ranges from 0 to 300 s.   | [Setting method]<br>Drag the slider.<br>[Default value]<br>120    |

## 7.2 Record Setting

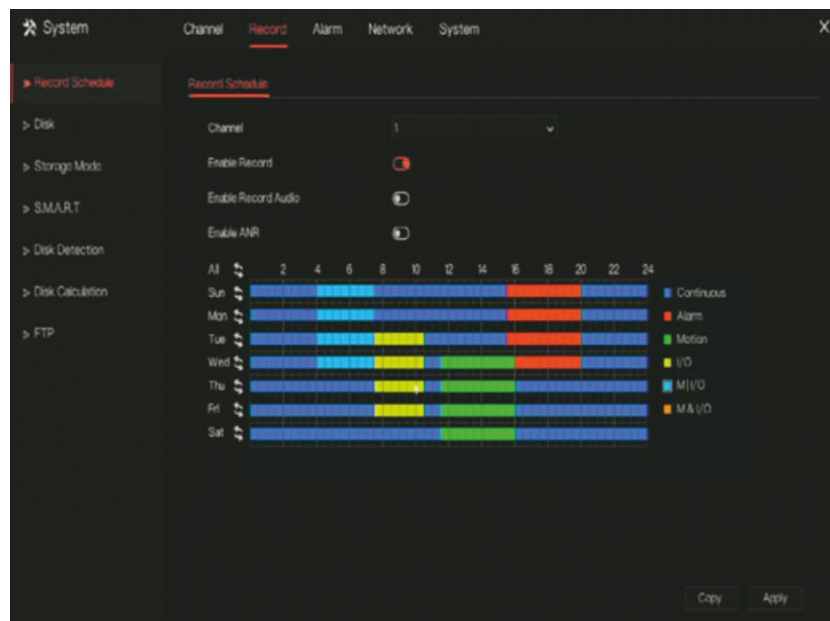
Set the **Record Schedule, Disk, Storage Mode, S.M.R.T, Disk Detection, Disk Calculation, FTP** and so on.

### 7.2.1 Record Schedule

Operation Description

Click **Record** in the main menu or click the record page of any function screen in the main menu to access the record schedule screen, as shown in Figure 7-22

Figure 7-22 Record management screen



#### Operation Steps


- Step 1 Select a channel from the drop-down list of channel option.
- Step 2 Enable the record.
- Step 3 Enable the record audio.
- Step 4 Enable ANR, the camera is installed with SD card, if the camera is disconnected from the network, when the network is recovered, the NVR can read the recording of camera and copy the loss video form the SD card.
- Step 5 Set the record schedule. Method 1: Hold down the left mouse button, drag and release mouse to select the arming time within 00:00-24:00 from Monday to Sunday.

**NOTE**

- When you select time by dragging the cursor, the cursor cannot move out of the time area. Otherwise, no time would be selected.
- The selected area is blue. The default is all week.
- User can choose alarm type to record, if the chosen alarm is happening at the setting time, it will record. So that it will using the disk effectively to avoid repeating useless recording.
- The ANR function can be used only for the cameras with supplementary recording function.
- User can set different alarms to record.

**Method 2:** Click  in the record schedule page to select the whole day or whole week.

Step 6 Deleting record schedule: Click  again or inverse selection to delete the selected record schedule.

Step 7 Click  and select channels or tick all, then click  to apply the record management settings to selected channels, click  to save settings.

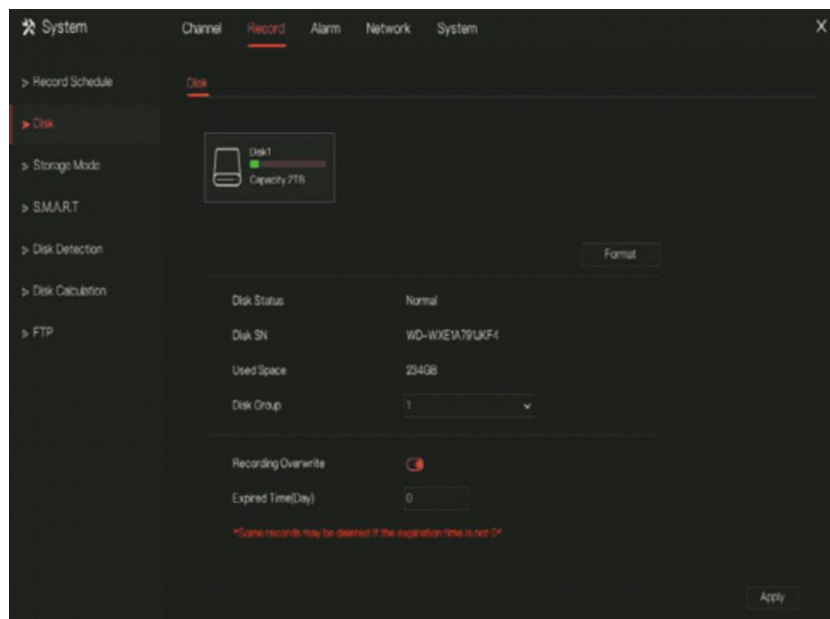
## 7.2.2 Disk

View the total capacity of disk, disk status, disk SN code and storage space of disk. You can format the disk and set record expiration time.

### Operation Description

Step 1 Click **Record** in the main menu or menu of the record screen and choose **Disk** to access the disk screen, as shown in Figure 7-23.

Figure 7-23 Disk screen



- Step 2 Click **Format**. The message "Are you sure to format disk? Your data will be lost" is displaying.
- Step 3 Choose the disk group, there are four groups.
- Step 4 Click **OK** ,and the disk would be formatted
- Step 5 Enable recording overwrite, the disk will be overwrite automatically.
- Step 6 Record expiration setting. Select record expiration days from the drop-down list of record expiration. The expired time is not 0, the records will be deleted when the time is over the setting value.
- Step 7 Click **Apply** to save the settings.

**NOTE**

The disk groups can keep the recording of channels at different disks, it will improve the storage efficiency. The expired time is 0, it means the disk will be rewrite only when the disk is full .

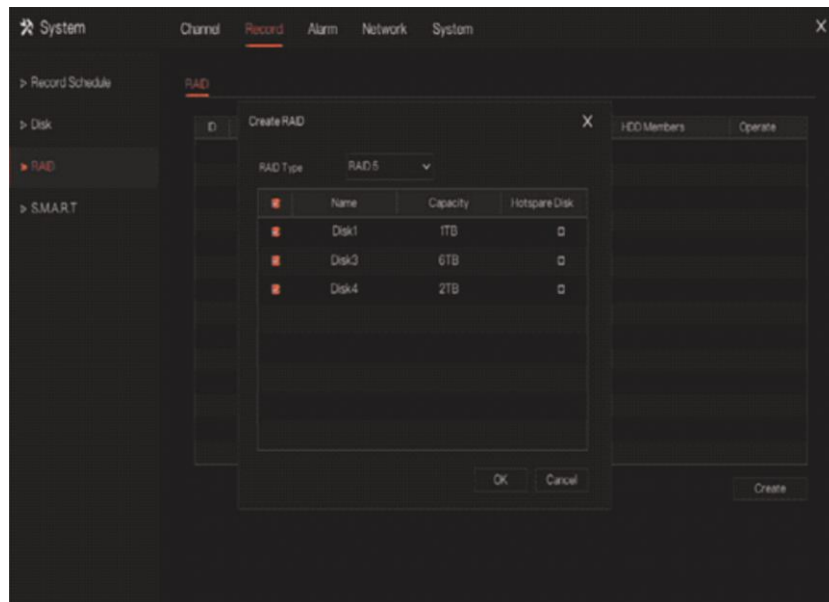
### 7.2.3 RAID

The NVR support to build/ edit/ delete the RAID. User can choose the type of RAID according to the importance of recording.

**NOTE**

RAID is only used for the device with 4 disks or more. And the disks must be enterprise level disks. The capacity of disks is better same for efficient using. RAID5 at least 3 disks can be created. RAID6 at least 4 disks can be created. RAID10 at least 4 disks can be created. Create hot spare disk need more one disk or double basic disks. The capacity of disks is better same for efficient using.

Figure 7-24 RAID



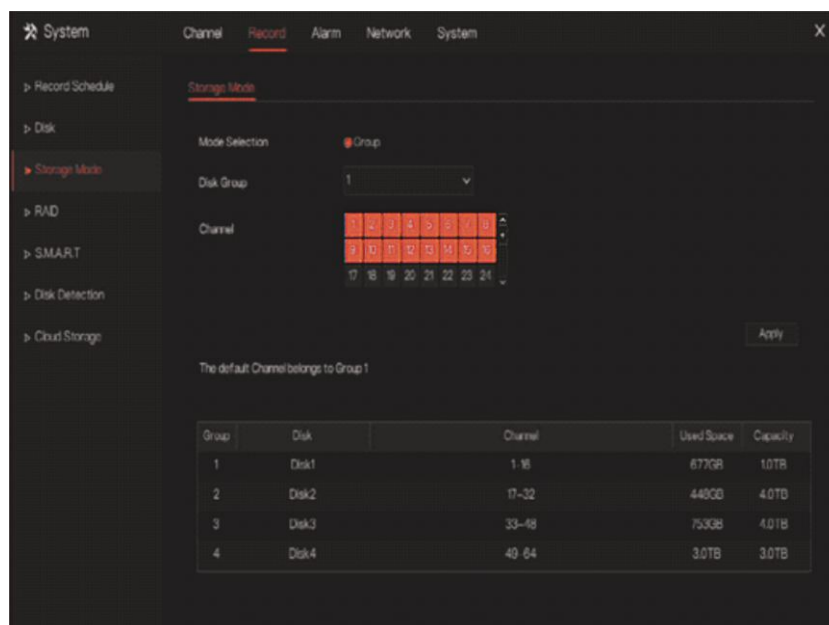
## Operation Steps

- Step 1 Click **RAID** to create the RAID.
- Step 2 Click **Create** to choose disk to create a new RAID.
- Step 3 Tick the  to back up the broken disk in case, the number of disk must more than basic disks.
- Step 4 Click  to save the creation, format the new RAID.

## 7.2.4 Storage Mode

User is based on need to distribute the channels to different disk group, and use disk capacity reasonably, as shown in Figure:7-25

Figure 7-25 Storage mode



## Operation Steps

- Step 1 Choose the disk group.
- Step 2 Select the channel to record to disk group.
- Step 3 Click **Apply** to save the settings.
- Step 4 The group list will show the detail information.

### NOTE

If the channels are not in list, it means NVR will not to record these channels, please make sure about all channels are in list. Choose number of channel number you should consider the capacity of disk group.

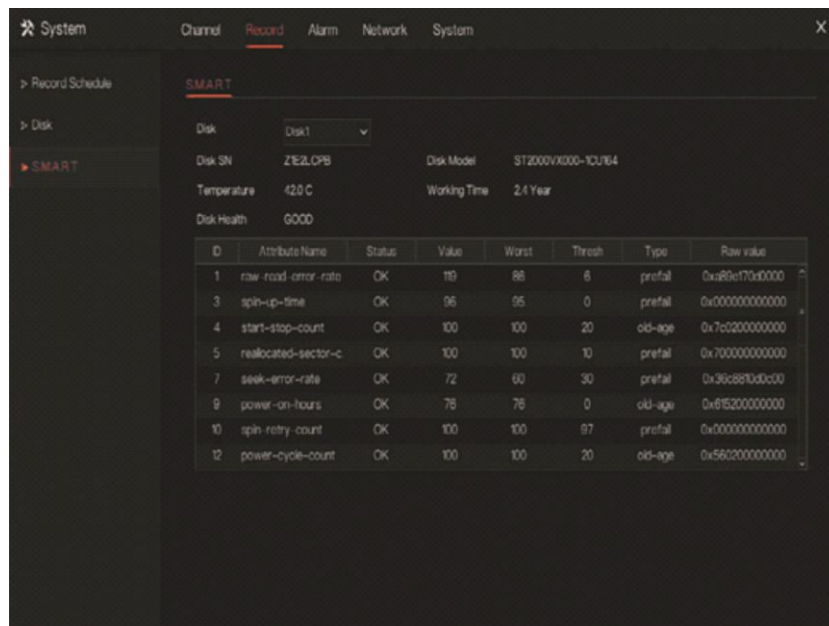


## 7.2.5 S.M.A.R.T

### 7.2.5.1 S.M.A.R.T

S.M.A.R.T is Self-Monitoring Analysis and Reporting Technology, user can view the health of disk, as shown in Figure 7-26

Figure 7-26 S.M.A.R.T



The screenshot shows the S.M.A.R.T monitoring interface. It displays the following information:

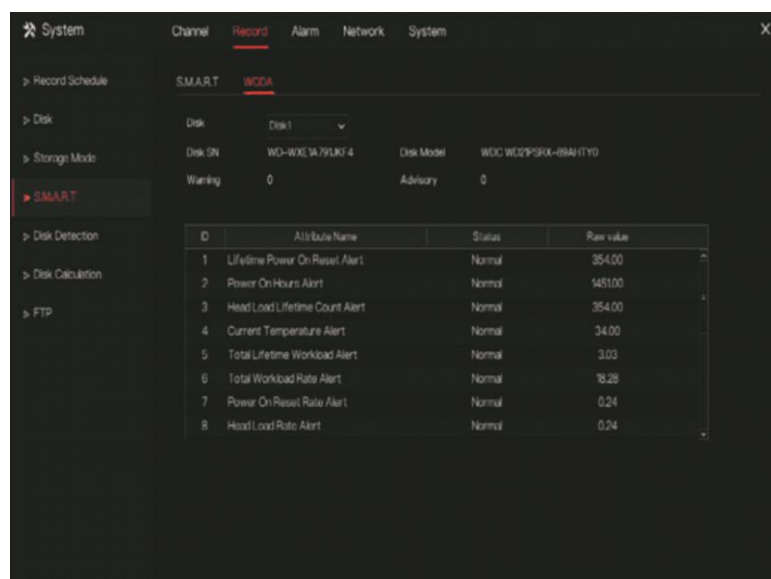
- SMART Summary:**
  - Disk: Disk1
  - Disk SN: ZEELOPB
  - Disk Model: ST2000VX000-1CU64
  - Temperature: 42.0 C
  - Working Time: 2.1 Year
  - Disk Health: GOOD
- SMART Attributes Table:**

| ID | Attribute Name       | Status | Value | Worst | Thresh | Type    | Raw value      |
|----|----------------------|--------|-------|-------|--------|---------|----------------|
| 1  | raw-read-error-rate  | OK     | 10    | 86    | 6      | prefail | 0x20e170d0000  |
| 3  | spin-up-time         | OK     | 96    | 95    | 0      | prefail | 0x000000000000 |
| 4  | start-stop-count     | OK     | 100   | 100   | 20     | old-age | 0x7c0200000000 |
| 5  | reallocated-sector-c | OK     | 100   | 100   | 10     | prefail | 0x700000000000 |
| 7  | seek-error-rate      | OK     | 72    | 60    | 30     | prefail | 0x30c8910d0c00 |
| 9  | power-on-hours       | OK     | 78    | 78    | 0      | old-age | 0x6f5200000000 |
| 10 | spin-retry-count     | OK     | 100   | 100   | 97     | prefail | 0x000000000000 |
| 12 | power-cycle-count    | OK     | 100   | 100   | 20     | old-age | 0x560200000000 |

### 7.2.5.2 WDDA

The western digital disk has the WDDA function, the NVR can read the information of disk, so that user can view the status of disk, as shown in Figure 7-27

Figure 7-27 WDDA



The screenshot shows the WDDA monitoring interface. It displays the following information:

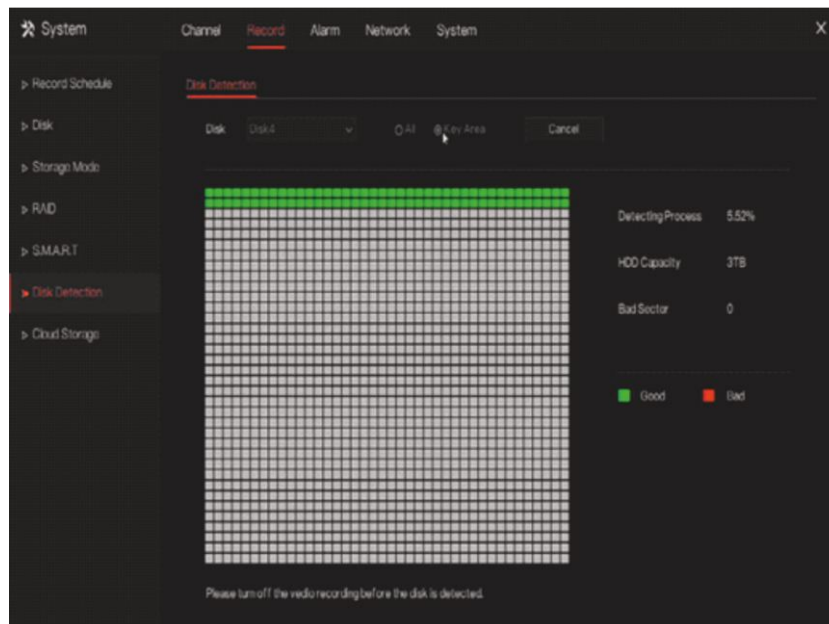
- WDDA Summary:**
  - Disk: Disk1
  - Disk SN: WD-WXEJA79UKF4
  - Disk Model: WDC WD20PURX-80A1TY0
  - Warning: 0
  - Advisory: 0
- WDDA Attributes Table:**

| ID | Attribute Name                 | Status | Raw value |
|----|--------------------------------|--------|-----------|
| 1  | Lifetime Power On/Reset Alert  | Normal | 354.00    |
| 2  | Power On Hours Alert           | Normal | 1451.00   |
| 3  | Head Load Lifetime Count Alert | Normal | 354.00    |
| 4  | Current Temperature Alert      | Normal | 34.00     |
| 5  | Total Lifetime Workload Alert  | Normal | 3.03      |
| 6  | Total Workload Rate Alert      | Normal | 78.28     |
| 7  | Power On/Reset Rate Alert      | Normal | 0.24      |
| 8  | Head Load Rate Alert           | Normal | 0.24      |

## 7.2.6 Disk Detection

Before the recording the video, user need to detect the disk to keep the data safety, as shown in Figure 7-28.

Figure 7-28 Disk Detection



### Operation Steps

- Step 1 Choose the disk from the drop-down list.
- Step 2 Tick all or key to detect the disk. Detect all need some time, detect key section maybe need a few minutes.
- Step 3 Click Scan to scan the disk.
- Step 4 The result of disk will show in interface

### NOTE

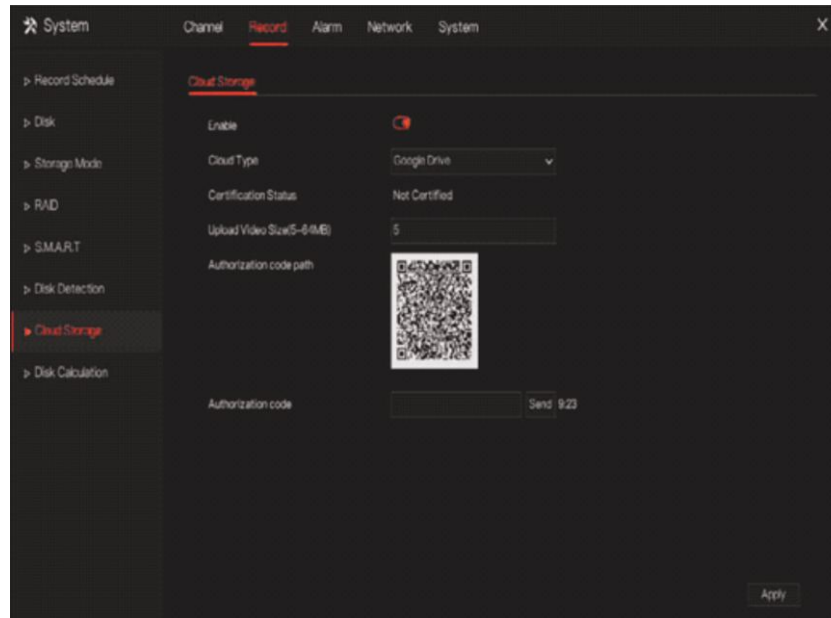
The green block means good, the red block means bad, if the red blocks are too much or at key section, please change the disk immediately.

Please turn off the video recording before the disk is detected, otherwise the recording of video maybe lost.

## 7.2.7 Cloud Storage (Only for Some Models)

The cloud storage can save the motion detection and intelligent analysis alarm, if user certificate the Google Drive.

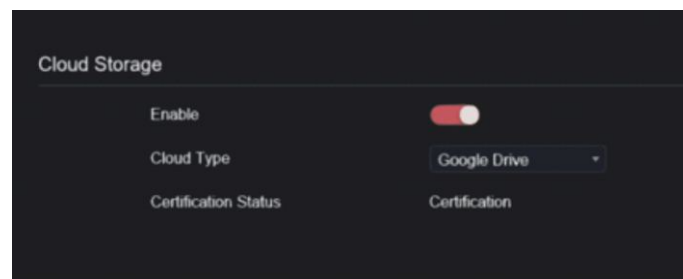
Figure 7-29 Cloud Storage



### Operation Steps

- Step 1 Enable the cloud storage, and the UUID of code path will show.
- Step 2 Choose the cloud type, the default is Google cloud.
- Step 3 Set upload video size, the video is saving in sub stream(the video size is less).
- Step 4 Use browser to scan the UUID to jump to Google drive certification, input the account and password to certificate the NVR.
- Step 5 Input the code , click Send to fish certificate, as shown in Figure 7-30

Figure 7-30 Certification



- Step 6 Click Apply to save the settings

**NOTE**

Google Cloud only needs to be authenticated once, without multiple authentications. After the authentication is completed, the cloud storage function can be turned on or off as required.

This function needs to be re-certified after the device is restored to factory settings. The UUID is the path of Google drive.

### 7.2.8 Disk Calculation

User can calculate the usage of disk, so that he can set the storage strategy reasonably, as shown in Figure 7-31. There are two modes can be set, computing capacity and computing time

Figure 7-31 Disk calculation of capacity

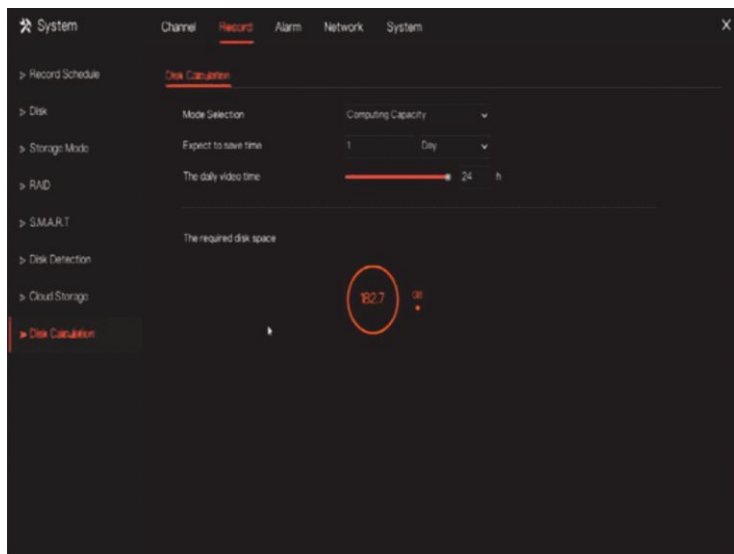
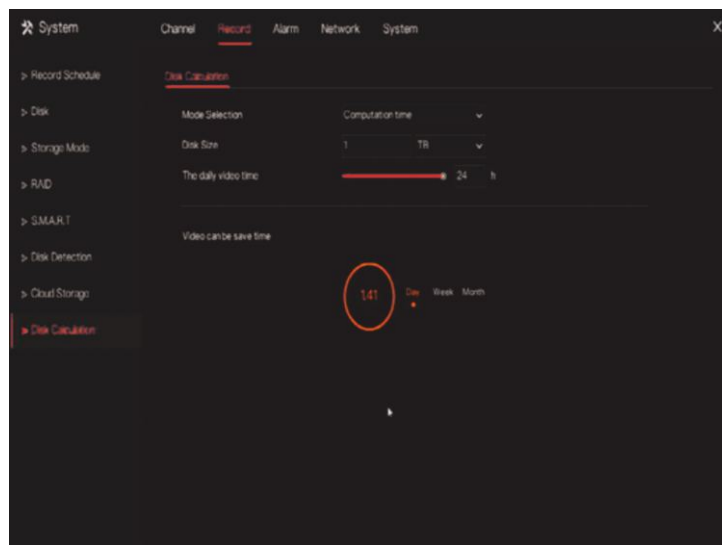


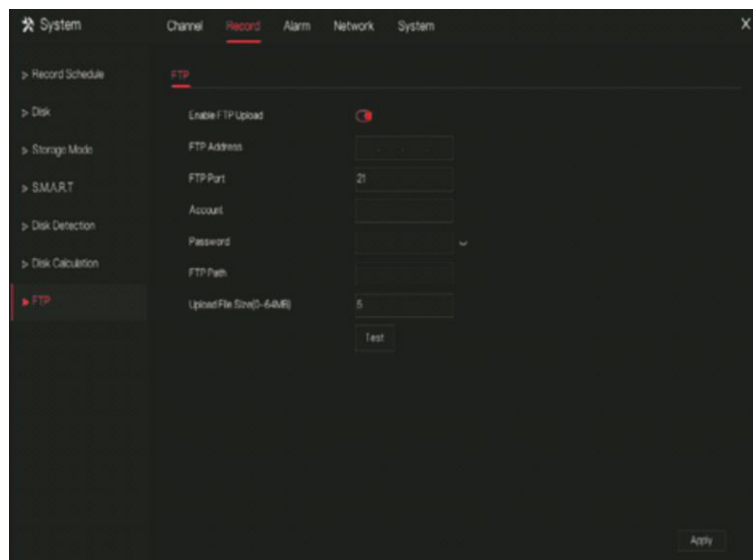
Figure 7-32 Disk calculation of time



## 7.2.9 FTP

Enable FTP upload, when the alarm happens, user can linkage the FTP upload to save the alarm recordings.

Figure 7-33 FTP



- Step 1 Enable the FTP upload.
- Step 2 Input the FTP address and port.
- Step 3 Input the account, password and FTP path.
- Step 4 Set the upload file size, it ranges from 0 to 64 MB.
- Step 5 Click "Test" to test the parameters, if test successfully, then to "Apply" to save the settings.

## 7.3 Alarm Management

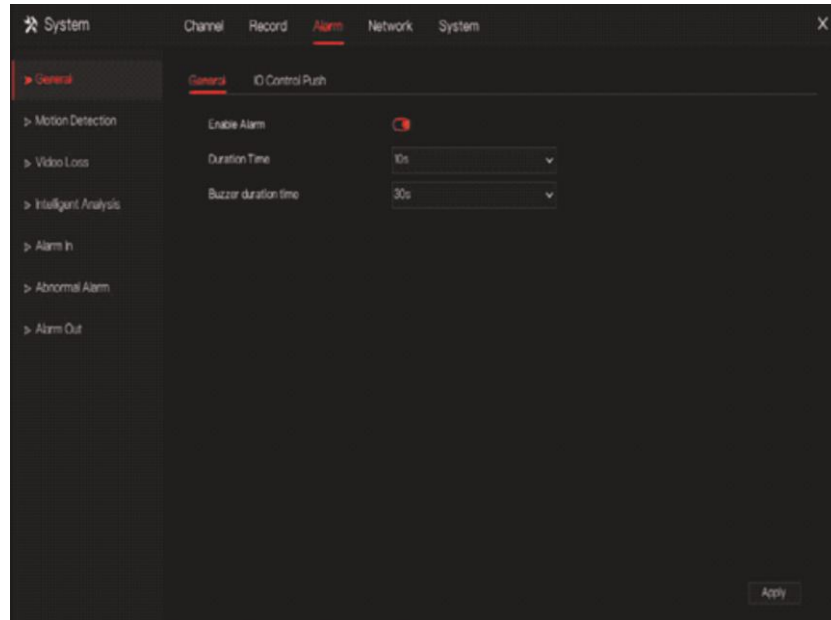
Set the **General alarm information, Motion Detection, Video Loss, Intelligent Analysis, Alarm In, Abnormal Alarm and Alarm out** in alarm management screen.

### 7.3.1 General

#### 7.3.1.1 General

Step 1 Click Alarm in the main menu (or click the alarm page of any function screen in the main menu) to access the alarm management screen, as shown in Figure 7-34

Figure 7-34 Alarm management screen



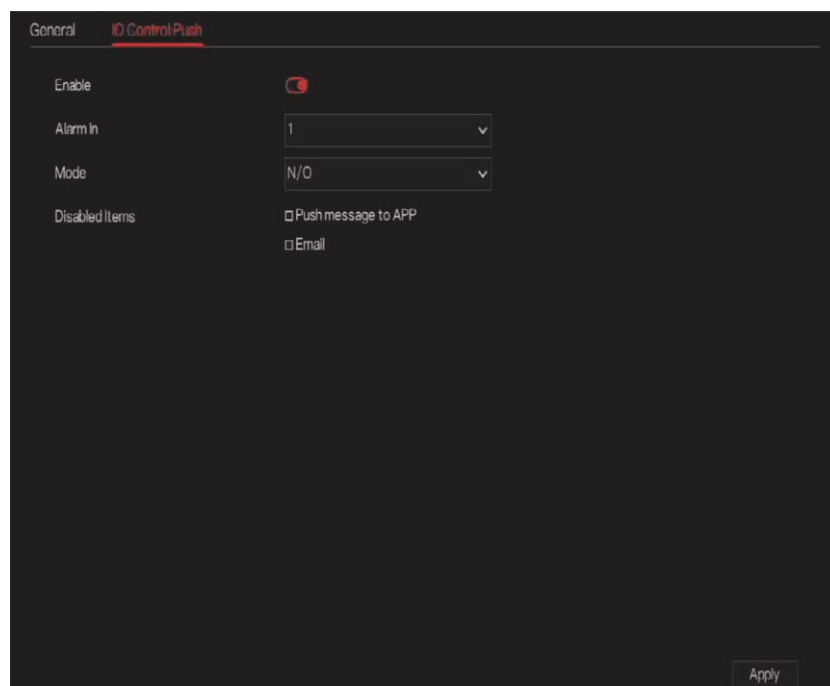
- Step 2 Enable the Enable alarm button.
- Step 3 Select a value from the drop-down list of duration time.
- Step 4 Click **Apply** to save alarm settings.

### 7.3.1.2 IO control push

If you select normally open and tick the disabled items, the alarm input 1 will not push message in the normally open state. Only when the alarm in 1 is in the normally closed, it can push alarm message.

Step 1 Enable the IO control push.

Figure 7-35 IO control push



Step 2 Choose one alarm in and mode(N/C, N/O).

Step 3 Tick the disable items, click "Apply" to save setting.

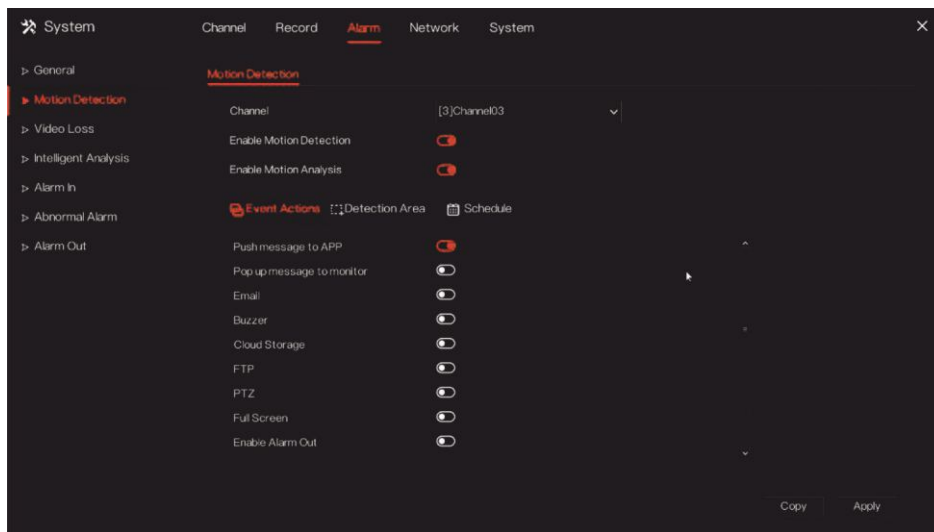
### 7.3.2 Motion Detection

The NVR will send motion detection alarm while something moving in the specific view of camera.

Operation Description

Step 1 Click **Motion Detection** in the main menu or menu of the alarm management screen and choose Motion Detection to access the **Motion Detection** screen, as shown in Figure 7-36

Figure 7-36 Motion detection screen



 **NOTE**

For Email, FTP, you should set the parameter of these in advance Enable Remote IO, the users connect the ADAM (data acquisition modules) to NVR in advanced alarm time the alarm will be duration. remote ID, the ADAM is connected to NVR's ID.

**Operation Steps**


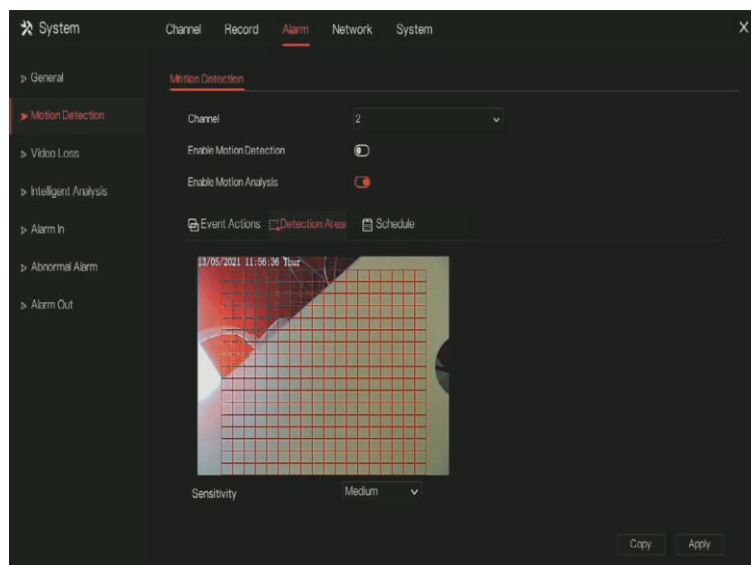
- Step 1 Select a channel from the drop-down list of channel.
- Step 2 Click  to enable motion detection.
- Step 3 Enable motion analysis, if the camera detect the motion action, the area will be block as shown in Figure 7-37.
- Step 4 Enable the Event actions include: push to APP, Email, FTP, Buzzer, Pop up message to monitor, Full screen, Cloud storage, Alarm out, Camera alarm out, Event recording, and so on.
- Step 5 Click Area page to access the motion detection area setting, as shown in Figure 7-37.

Figure 7-37 Motion detection area setting screen





**Area :**

1. Hold down and drag the left mouse button to draw a motion detection area.
2. Select a value from the drop-down list next to Sensitivity.

Step 6 Click Schedule page to access the schedule screen. For details, please see 7.2.1 Record schedule figure 7-22 Step 5 Set the record schedule

Step 7 Click **Copy** and select channels or tick all, then click **OK** to apply the motion detection settings to cameras in selected channels, click **Apply** to save motion detection alarm settings.

 **NOTE**

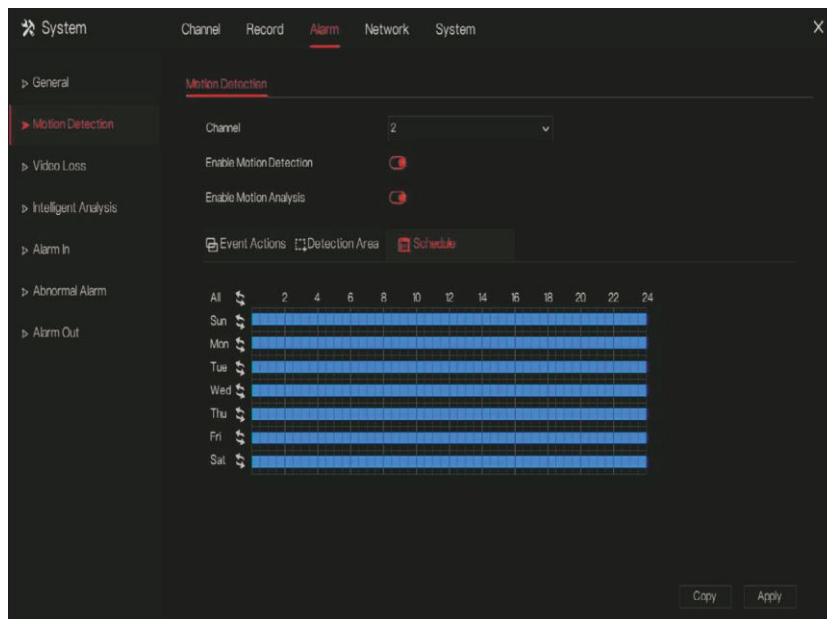
After a motion detection area is selected, double-click it to delete the selected area. The default area is whole area.

If you leave the page without applying, the tip "Do you want to save?" would show. Click save to save the settings. Click cancel to quit the settings.

Enable the alarm out, user need to set alarm time and output ID, four ID are corresponding to back panel's alarm out, 1 A and 1 B, 2 A and 2 B, 3 A and 3 B, 4 A and 4 B.

Channel alarm out is corresponding to alarm port of camera.

Figure 7-38 Alarm schedule



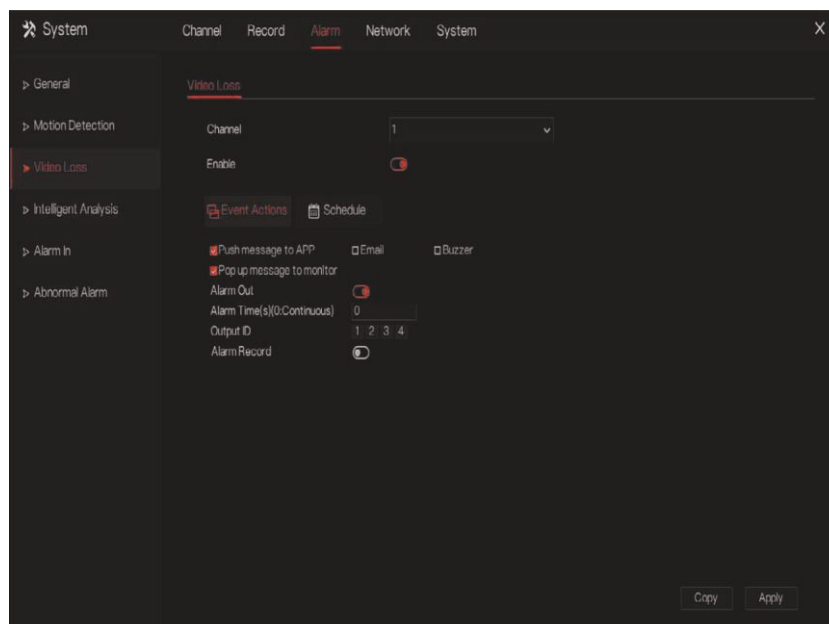
### 7.3.3 Video Loss

If a camera is disconnected to NVR, it will trigger video loss alarm.





#### Operation Description

Click **Video Loss** in the main menu or menu of the alarm management screen and choose **video Loss** to access the video loss screen, as shown in Figure 7-36.

Figure 7-39 Video Loss Screen



#### Operation Steps

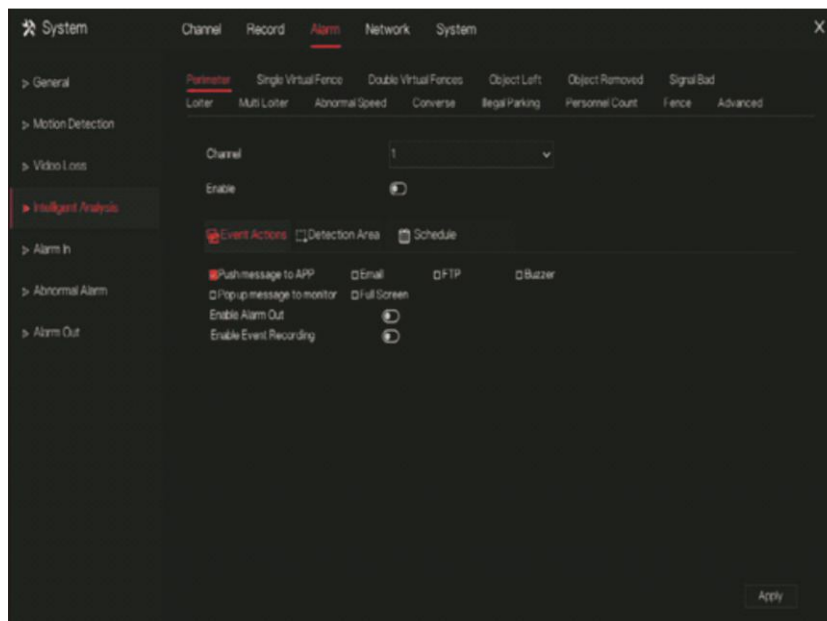
- Step 1 Select a channel from the drop-down list of channel.
- Step 2 Click  to enable video loss alarm.
- Step 3 Enable the Event actions include: buzzer, alarm out, push message, pop up message, send E-mail and post recording.
- Step 4 Click Schedule page to access the schedule screen.
- Step 5 For details, please see 7.2.1 Record Schedule Figure 7-22 Step 5 Set the record schedule.
- Step 6 Click  and select a channel, then click  to apply the parameter settings to cameras in selected channels, click  to save video loss settings.

### 7.3.4 Advanced Intelligent Analysis (Only for Some Models)

#### Operation Description

Step 1 Click **Intelligent Analysis** in the main menu or menu of the alarm management screen and choose Intelligent Analysis to access **intelligent analysis** screen, as shown in Figure 7-40


Figure 7-40 Intelligent Analysis screen



#### Operation Steps

Step 2 Select one action to set the alarm. (perimeter, single virtual fence, double virtual fences, object left, signal bad, loiter, multi loiter, abnormal speed, converse, illegal parking, personnel count, fence, advanced)

Step 3 Select a channel from the drop-down list of channel.

Step 4 Click  to enable intelligent analysis alarm.

Step 5 Enable the event actions include: buzzer, alarm out, push message, pop up message, send E-mail and post recording.

Step 6 Click Schedule page to access the schedule screen.

Step 7 For details, please see Figure 7-19 Step 5 Set the record schedule.

Step 8 Click  and select a channel, then click  to apply the parameter settings to cameras in selected channels, click  to save video loss settings.

Figure 7-41 Personnel count

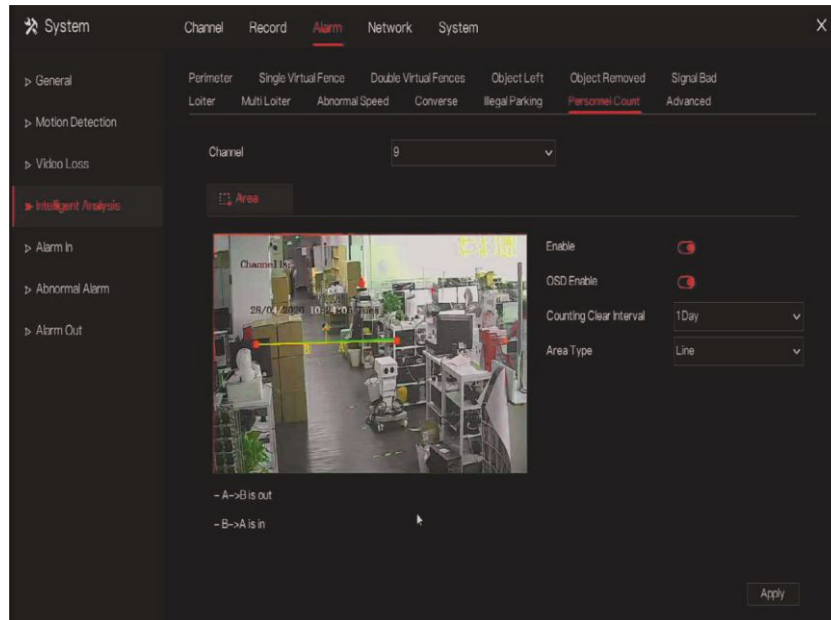


Table 7-12 Personnel count parameters

| Parameter               | Description  | Setting   |
|-------------------------|--|---|
| Enable                  | Enable the button to enable the personnel count  | [How to set]<br>Click Enable to enable.<br>[Default value]<br><b>OFF</b>      |
| OSD enable              | Enable, the statistical data of personnel count will show on OSD                       | [How to set]<br>Click Enable to enable .<br>[Default value]<br><b>OFF</b>     |
| Counting clear interval | There are five modes can be chosen, such as 10 min, half-hour, 1 hour, 12 hour, 1 day. | [Setting method]<br>Choose from drop-down list<br>[Default value]<br><b>7</b> |
| Area type               | The area to count personnel.   | [Default value]<br><b>Line</b>  |

**Fence:**

The fence is only support fence AI multi-object cameras, when the detection area is found person or car, it will alarm. When happens the fence alarm, user can choose many event actions to alarm.

Figure 7-42 Fence

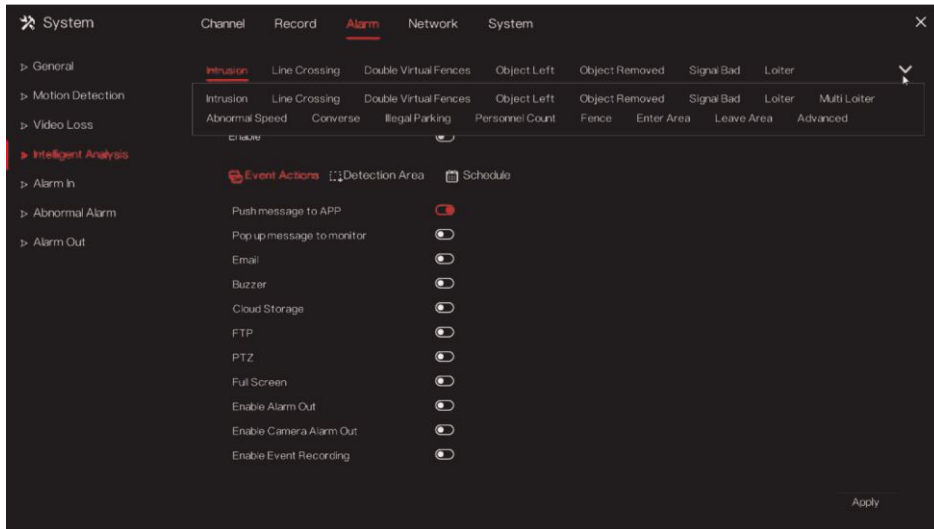
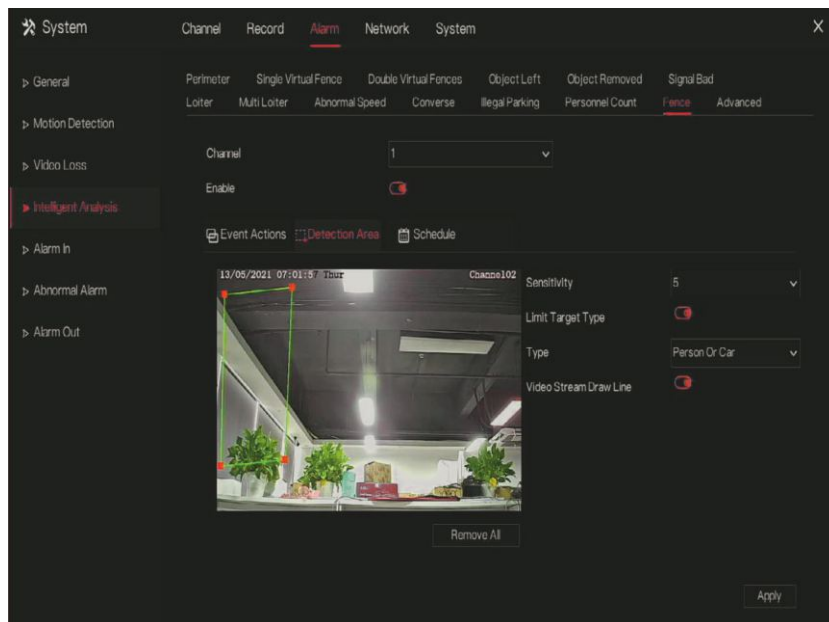


Figure 7-42 Fence detection area



Enable limit target type, choose the type(person or car, person, car).Enable video stream draw line, when detect the car or person, it will show the blue frame to mark the target.

Use the mouse to draw the detection area, user can draw serval areas depending on the real condition.

### 7.3.5 Alarm In

 **NOTE**

This function requires access to a camera that supports external alarm in.

There two types alarm in, one is the NVR's alarm in, another is the camera channel's alarm in.

Operation Description

Click Alarm in in the main menu or menu of the alarm management screen and choose Alarm in to access the alarm in screen, as shown in Figure 7-44

Figure 7-44 Alarm in screen

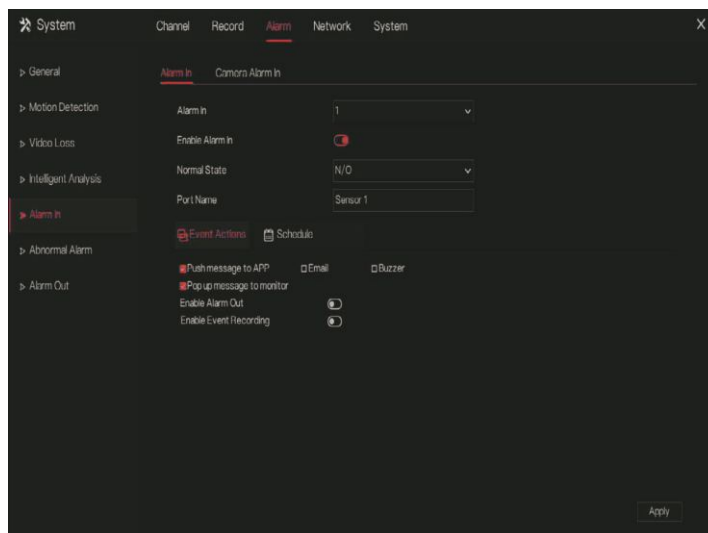
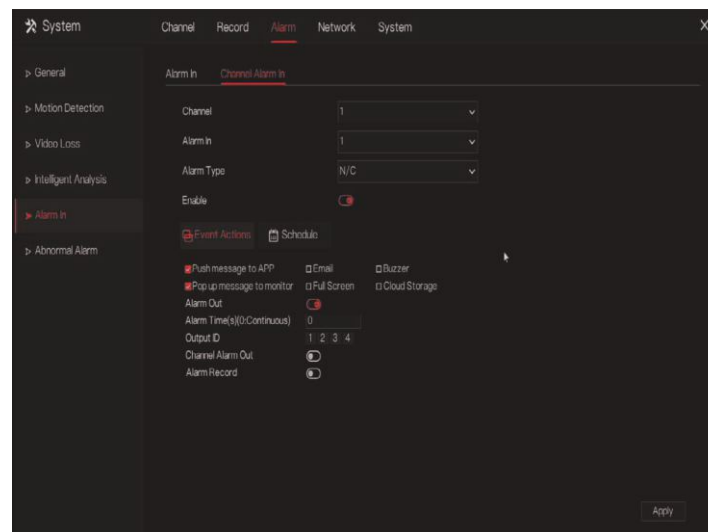



Figure 7-45 Camera alarm in

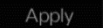


## Operation Steps

- Step 1 Select a channel in **alarm in**.
- Step 2 Click  to enable or disable the functions.
- Step 3 Select Alarm type from the drop-down list.

### NOTE

NC: Normal close the alarm  
 NO: Normal open the alarm

- Step 4 Set **name**.
- Step 5 Enable the event actions include: buzzer, alarm out, push message, pop up message, send E-mail and post recording.
- Step 6 Click **Schedule** page to access the schedule screen. For details, please see 7.2.1 Record Schedule Figure 7-22 Step5 set the record schedule.
- Step 7 Click  to save alarm in settings.

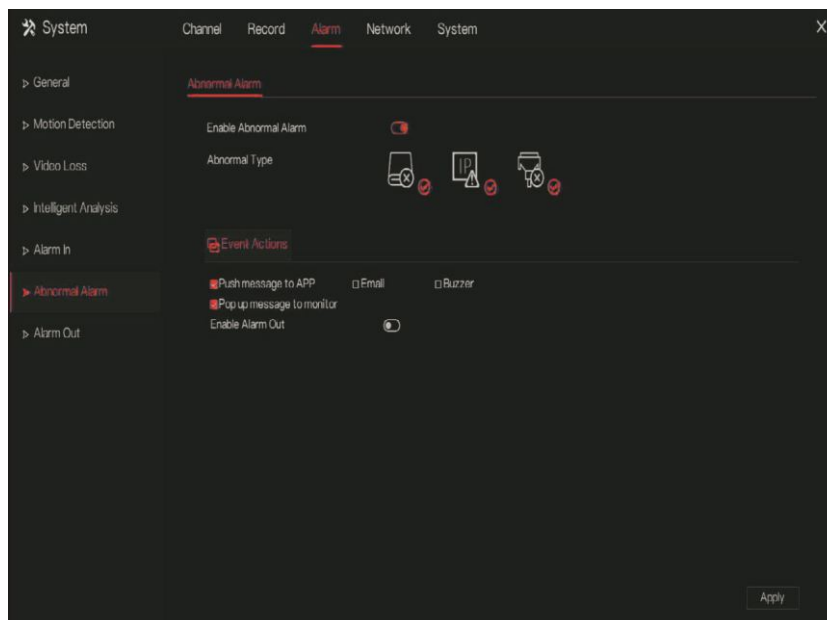
## 7.3.6 Abnormal Alarm


Abnormal alarm includes disk alarm, IP conflict and network disconnected.

- Step 1 Click **Abnormal Alarm** in the main menu or menu of the alarm management screen and choose **Abnormal Alarm** to access the abnormal alarm screen, as shown in Figure 7-46

### Operation Description after disconnected

Figure 7-46 Abnormal alarm screen



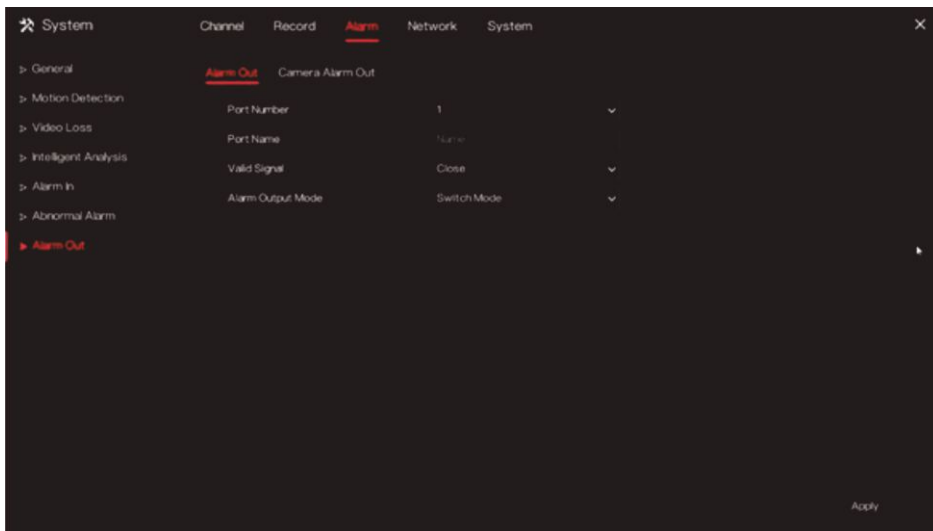
- Step 2 Tick the abnormal actions.
- Step 3 Enable the event actions include: buzzer, alarm out, push message, pop up message, send E-mail and post recording.
- Step 4 Click  to save abnormal alarm settings.

## 7.3.7 Alarm Out

### 7.3.7.1 Alarm Out

Choose one output ID as the output interface.

Figure 7-47 Alarm out



### 7.3.7.2 Camera Alarm Out

#### NOTE

This function requires access to a camera that connected to an external alarm out device

Figure 7-48 Camera Alarm out

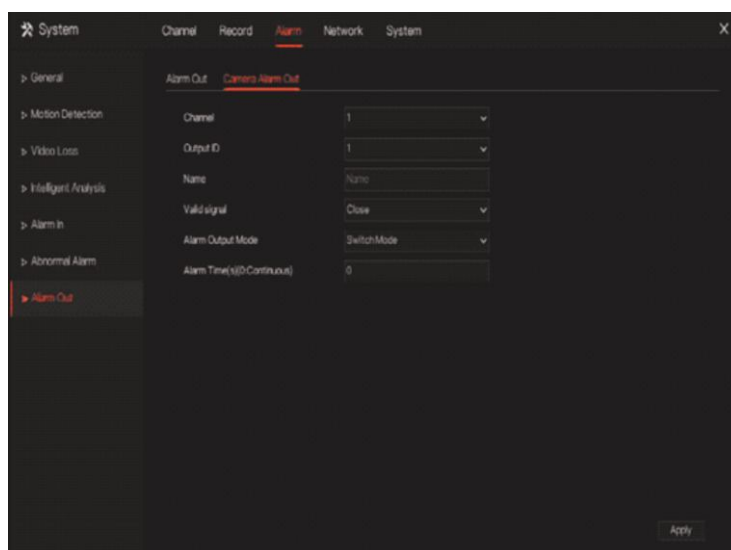




Table 7-13 Camera Alarm out

| Parameter                      | Description  | Setting  |
|--------------------------------|--|--|
| Alarm Output                   | ID of the alarm output channel.<br><br>NOTE<br><br>The number of alarm output channels depends on the device model.  | [Setting method]<br>Select a value from the drop-down list box.<br>[Default value]<br>1                    |
| Name                           | Alarm output channel name.   | [Value range]<br>0 to 32 bytes   |
| Valid Signal                   | The options are as follows: <ul style="list-style-type: none"> <li>• <b>Close:</b> An alarm is generated when an external alarm signal is received.</li> <li>• <b>Open:</b> An alarm is generated when no external alarm signal is received.</li> </ul>  | [Setting method]<br>Select a value from the drop-down list box.<br>[Default value]<br>Close                |
| Alarm Output Mode              | When the device receives I/O alarm signals, the device sends the alarm information to an external alarm device in the mode specified by this parameter. The options include the switch mode and pulse mode.<br><br>NOTE <ul style="list-style-type: none"> <li>• If the switch mode is used, the alarm frequency of the device must be the same as that of the external alarm device.</li> <li>• If the pulse mode is used, the alarm frequency of the external alarm device can be configured.</li> </ul> | [Setting method]<br>Select a value from the drop-down list box.<br>[Default value]<br>Switch Mode          |
| Alarm Time(ms) (0: Continuous) | Alarm output duration. The value 0 indicates that the alarm remains continuous valid.  | [Setting method]<br>Enter a value manually.<br>[Default value]<br>0<br>[Value range]<br>0 to 86400 seconds |
| Manual Control                 | Control the alarm output.  | N/A  |

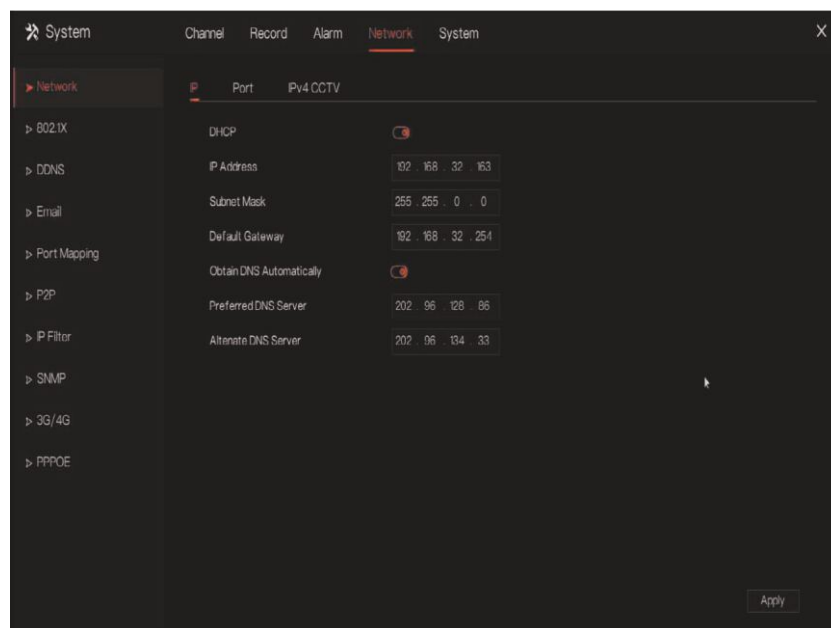
## 7.4 Network Management

Set the **Network Parameter, 802.1X, DDNS, E-mail, Port Mapping, P2P, IP Filter, SNMP 3G/4G and PPPOE, Network Traffic** in the network management screen.

### Operation Description

Step 1 Click **Network** in the main menu (or click the network page of any function screen in the main menu) to access the network management screen, as shown in Figure 7-49

Figure 7-49 Network management screen





### 7.4.1 Network

Set **DHCP** and **DNS** manually or automatically.

#### 7.4.1.1 IP

##### Operation Steps

- Step 1 Click  next to DHCP to enable or disable the function of automatically getting an IP address. The function is disabled by default.
- Step 2 If the function is disabled, click input boxes next to IP, Subnet mask, and Gateway to set the parameters as required.
- Step 3 Click  next to Obtain DNS Automatically to enable or disable the function of automatically getting a DNS address. The function is enabled by default.
- Step 4 If the function is disabled, click input boxes next to DNS 1(default 192.168.0.1) and DNS 2(default 8.8.8.8), delete original address, and enter new address.

#### Operation Steps

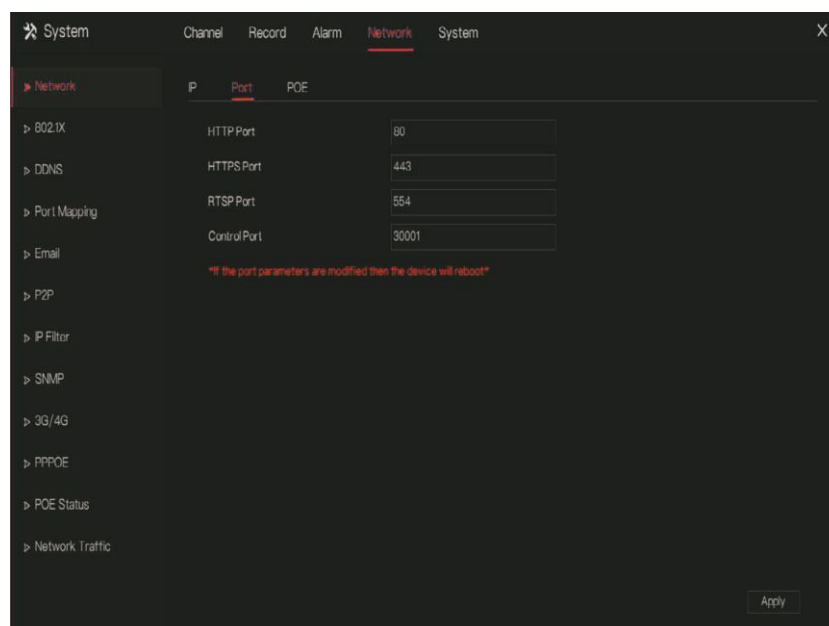
Step 1 Click **Apply** to save IP settings.

#### 7.4.1.2 Port

#### Operation Steps

Step 1 Click **Port** page to access the port setting screen, as shown in Figure 7-50

Figure 7-50 Port setting screen



Step 1 Set the HTTP port, HTTPS port, RTSP port and Control port.

Step 2 Click **Apply** to save port settings.

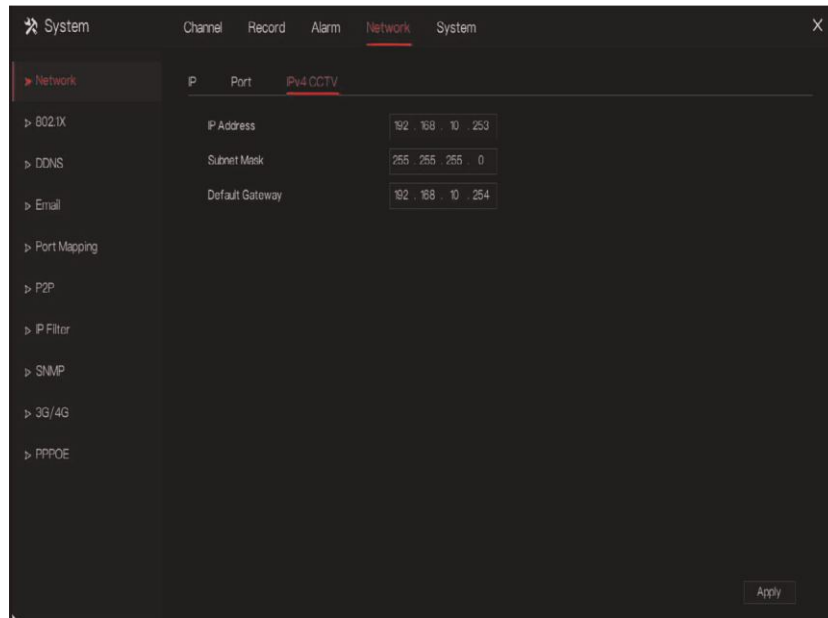
#### 7.4.1.3 IPv4CCTV (Only for Some Models)

The no PoE device has two LANs, LAN1 and LAN2.

#### Operation Steps

Step 1 Click **IPv4 CCTV** page to access the LAN2 setting screen, as shown in Figure 7-51

Figure 7-51 IPv4 CCTV



Step 2 Input the IP address, subnet mask, default gateway.

Step 3 Click **Apply** to save the settings.

#### NOTE

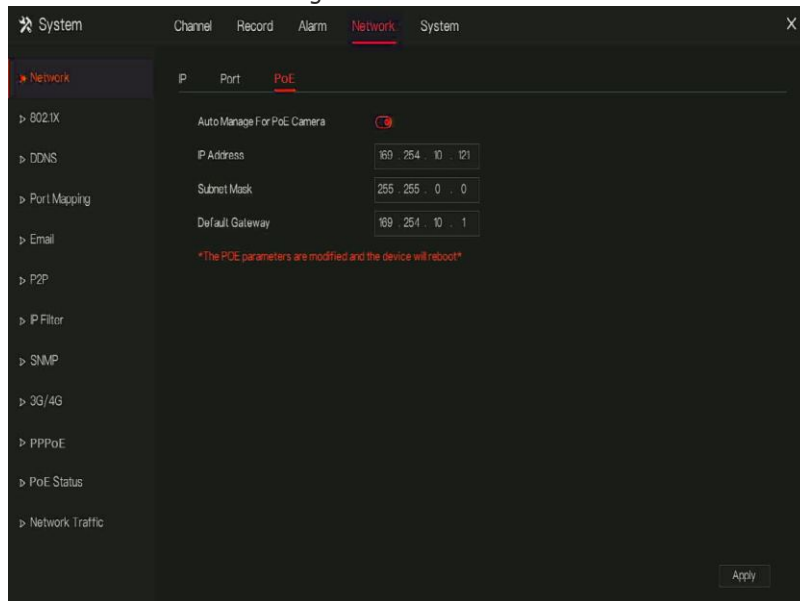
LAN1 and LAN2 can connect to different network, so that NVR can add more cameras. LAN1 usually connect to the external network, it is default gateway. LAN2 connect to internal network.

#### 7.4.1.4 PoE

##### Operation Steps

Step 1 Click **PoE** page to access the PoE setting screen, as shown in Figure 7-52

Figure 7-52 PoE Screen



Step 2 The NVR will deploy IP addresses to the cameras which connect PoE immediately.

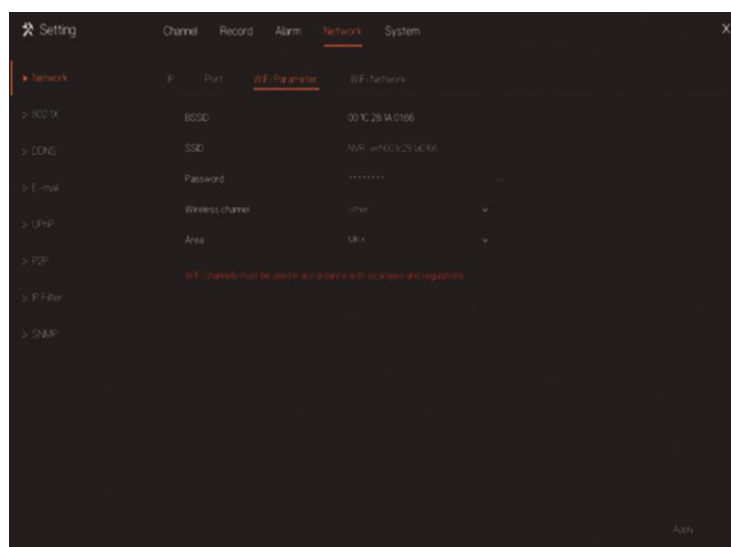
Step 3 Click **Apply** to set POE camera IP address successfully.

#### 7.4.1.5 Wi-Fi Parameter (Only for Some Models)

##### Operation Steps

Step 1 Click **Wi-Fi Parameter** page to access the Wi-Fi Parameter setting screen, as shown in Figure 7-53

Figure 7-53 Wi-Fi Parameter



Step 2 Set the parameters of Wi-Fi

Step 3 Click **Apply** to set PoE camera IP address successfully.

 **NOTE**

BSDID, default value of the device, cannot be changed.

SSID, the name can be changed to facilitate customer search.

WiFi channel, 1-13 channels, plus the other channel, can be changed according to network blocking conditions to avoid interference.

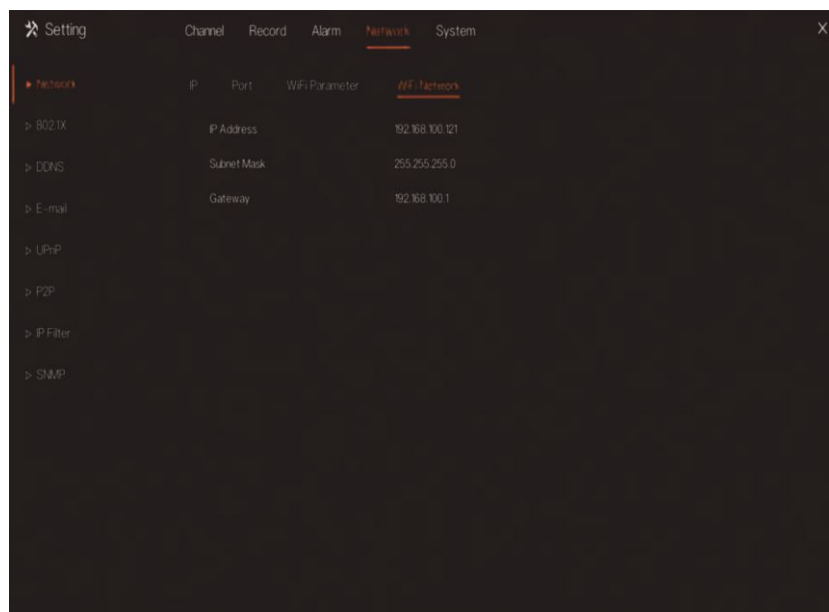
The area can be selected according to the country where it is located, MKK, ETSI1, ETSI2, FCC.

### 7.4.1.6 Wi-Fi Network (Only for Some Models)

#### Operation Steps

Step 1 Click **Wi-Fi** Parameter page to access the WiFi Parameter setting screen, as shown in Figure 7-54

Figure 7-54 Wi-Fi Network



### 7.4.2 802.1 X

#### Operation Steps


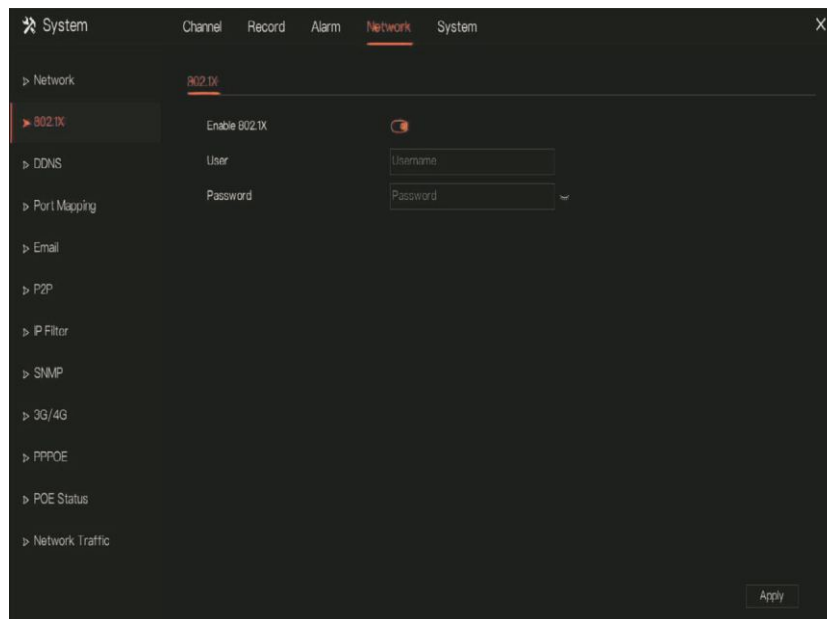

Step 1 Click  next to **802.1 X** to enable or disable the function . The default is disabled.

Figure 7-55 802.1X



Step 2 Input the user and password of 802.1X, the account is created by user.

Step 3 Click  to save the settings. The visitor to view the NVR need to input account to certify.

### 7.4.3 DDNS

Please make sure of connecting the specified camera to the Internet, and obtain the user name and password for logging into the dynamic domain name system (DDNS) from the server.

#### Operation Steps

Step 1 Click **DDNS** in the main menu or menu of the network management screen and choose **DDNS** to access the DDNS screen.


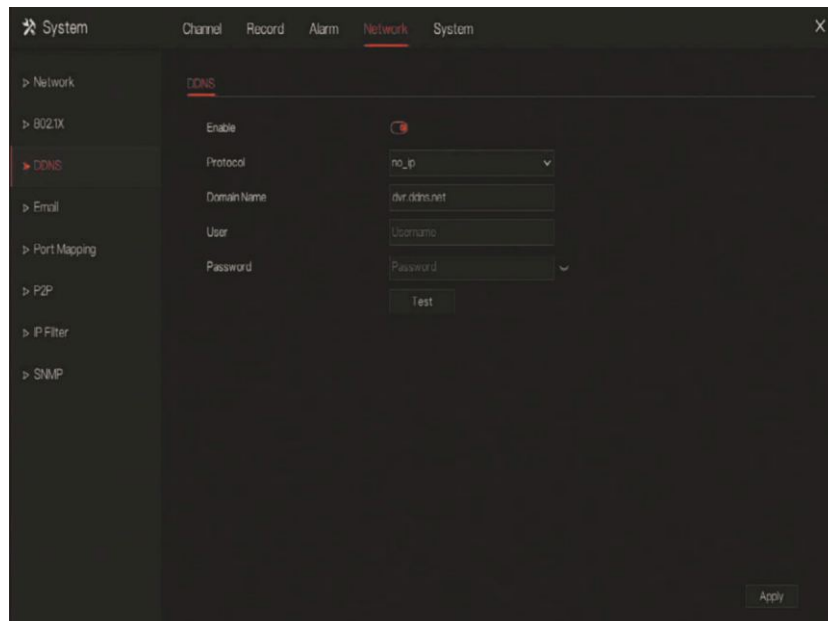
Step 2 Click  next to Enable to enable the DDNS function. It is disabled by default, as shown in Figure 7-56

Figure 7-56 DDNS setting screen



Step 3 Select a required value from the protocol drop-down list.

Step 4 Set domain name, input user and password.

Step 5 Click **Test** to check the domain name.

Step 6 Click **Apply** to save DDNS network settings.

#### NOTE

An external network can access the NVR via an address that is set in the DDNS settings.

## 7.4.4 Port Mapping

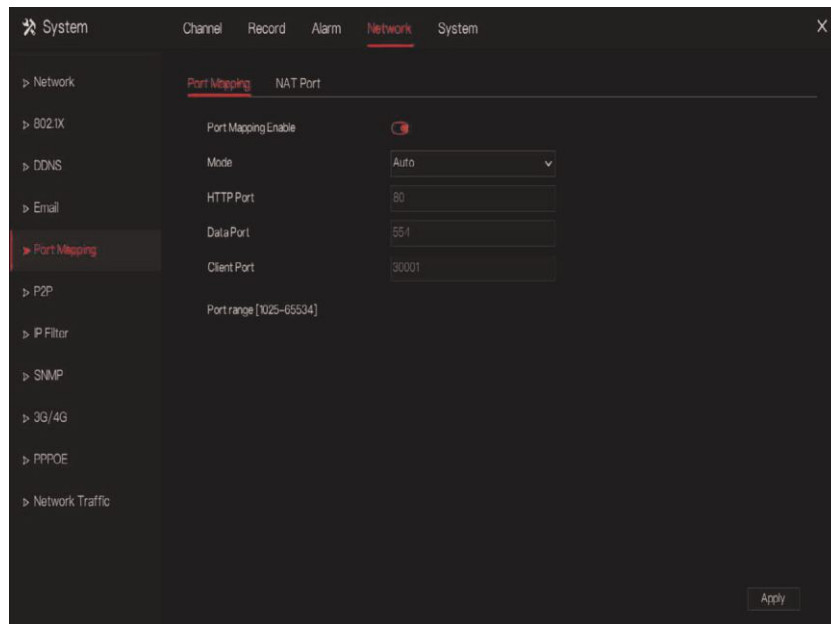
### 7.4.4.1 Port Mapping

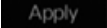
#### Operation Steps

Step 1 Click **Port Mapping** in the main menu or menu of the network management screen and choose **Port Mapping** to access the port mapping screen, as shown in Figure 7-57



Figure 7-57 Port mapping setting screen



- Step 2 Select UPnP enable type.
- Step 3 Manual UPnP: input http port, data port and client port manually.
- Step 4 Auto UPnP: device obtain the port automatically.
- Step 5 Click  to save settings.

#### 7.4.4.2 NAT Port


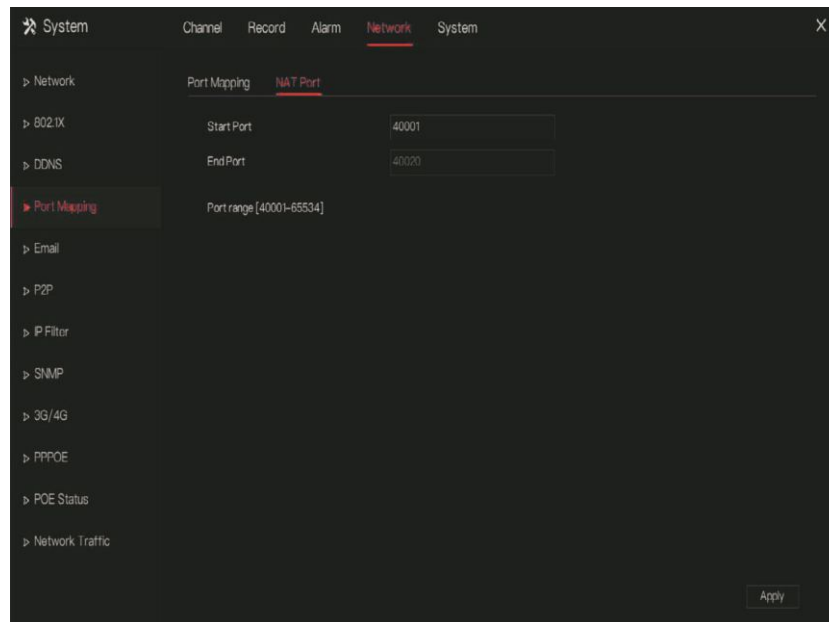
NAT port (network address translation) user can through NAT port to access the channels of NVR. User can set the start port, and it will generate the end port automatically. We will view the NAT port when we access the channel through clicking  icon at Web interface.

Figure 7-58 NAT Port



## 7.4.5 E-mail

If the simple mail transfer protocol (SMTP) function is enabling, the device automatically sends alarm information to specified email addresses when an alarm is generated. User can use two mailbox to send information.

### Operation Steps

- Step 1 Click **E-mail** in the main menu or menu of the network management screen and choose E-mail to access the **E-mail** screen, as shown in Figure 7-59

Figure 7-59 E-mail setting screen

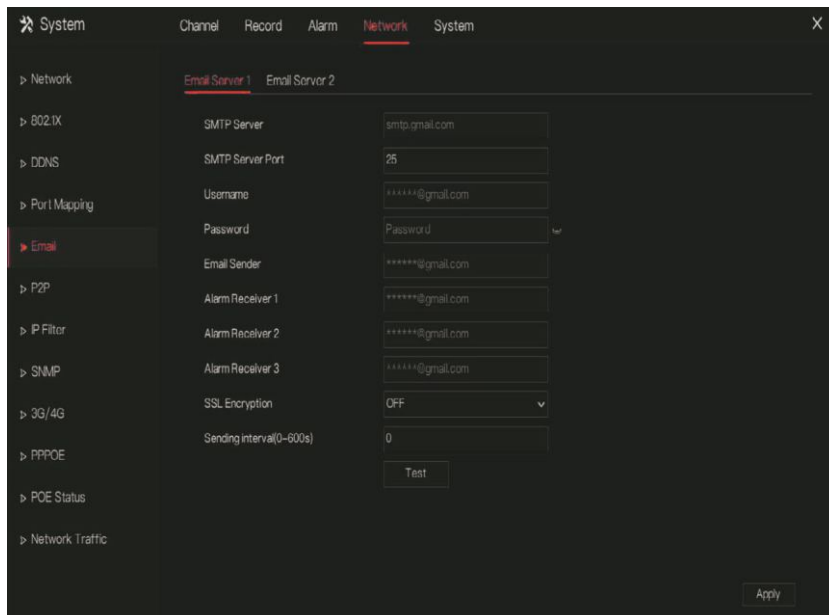
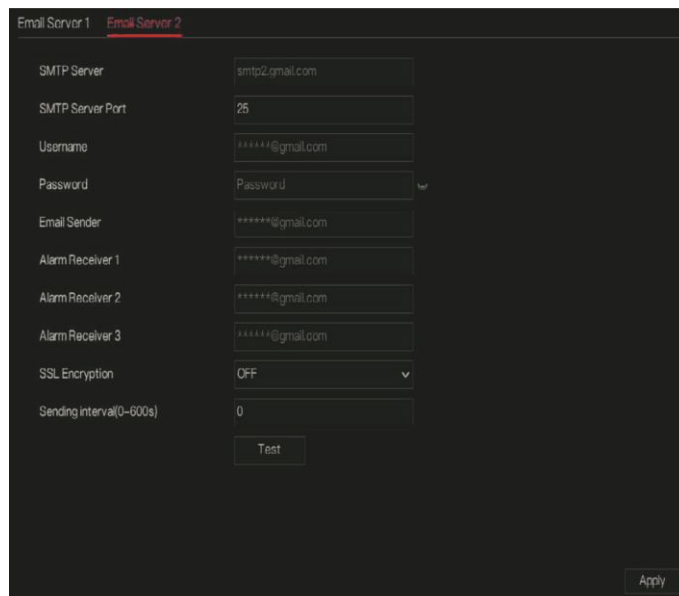



Table 7-14 E-mail server 2



- Step 2 Set SMTP server and SMTP server port manually.
- Step 3 Input E-mail sender, user name and password manually.
- Step 4 Set E-mail for receive alarm. the message **"Mail has been sent, please check"** is displaying. Open the mail, if the verification code is received, that shows the E-mail is set successfully.
- Step 5 Set E-mail for retrieve the password. the message "Mail has been sent, please check" is displaying. Open the mail, if the verification code is received, that shows the E-mail is set successfully.
- Step 6 Set SSL encryption for encrypting mail or not, set sending interval.
- Step 7 Click  to save settings.

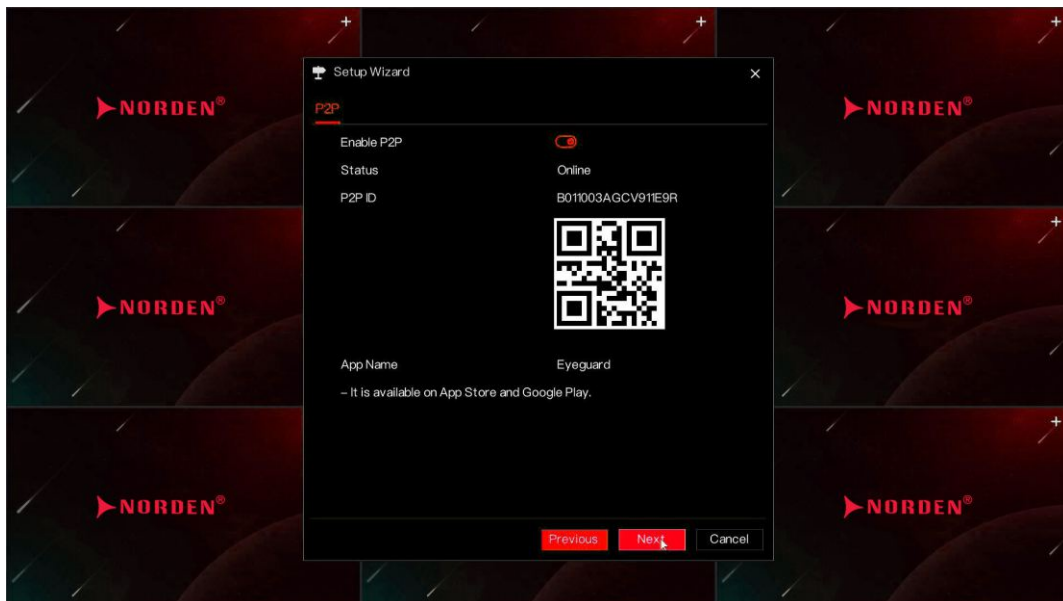
## 7.4.6 P2P



Show the UUID code and set the P2P status of the device.

### Operation Steps

- Step 1 Click **P2P** in the main menu or menu of the network management screen and choose **P2P** to access the P2P screen, as shown in Figure 7-60

Figure 7-60 P2P screen



- Step 2 Click  to enable the P2P function.
- Step 3 Click  to save P2P network settings or click Cancel to cancel settings.
- Step 4 After the **Inview Pro4** is installed in mobile phone, run the APP and scan the QR to add and access the NVR when the device is online.

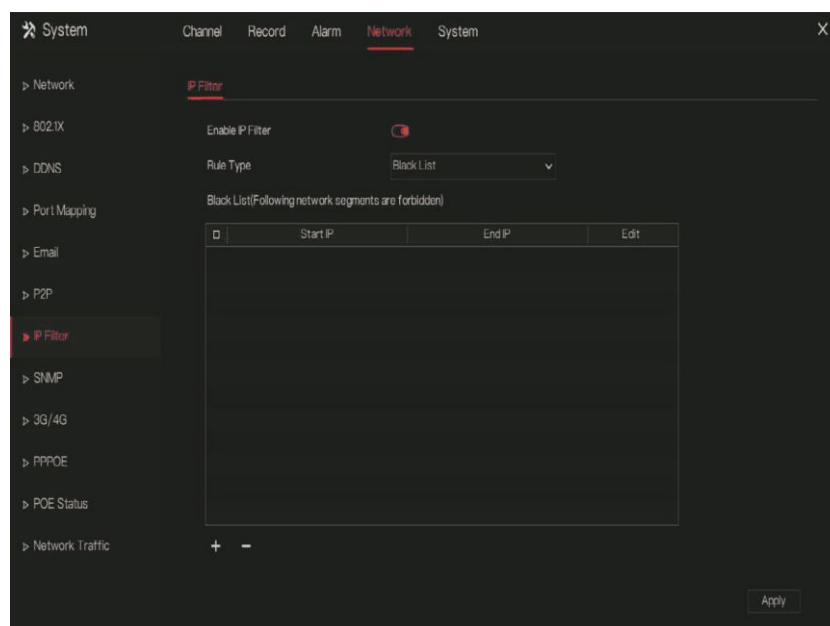
### 7.4.7 IP Filter

Set the IP address in specified network segment to allow or prohibit access.

#### Operation Steps

- Step 1 Click IP Filter in the main menu or menu of the network management screen and choose IP Filter to access the IP filter screen, as shown in Figure 7-61.

Figure 7-61 Filter setting screen



- Step 2 Click  next to IP Filter to enable the function of IP Filter.

- Step 3 Select black list or white list drop-down list.


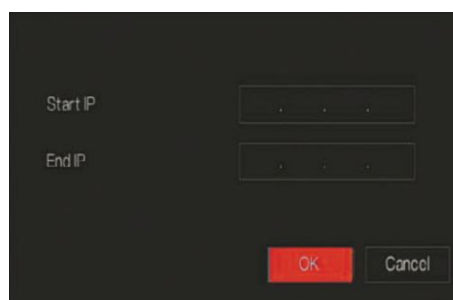
- Step 4 Click  to set black & white list IP segment screen is displaying, as show in Figure 7-62

Figure 7-62 Address Segment screen



Step 5 Enter value manually for start IP address, end IP address.

Step 6 Click  . The system saves the settings. The black and white lists IP segment listed in the black (white) list.

 **NOTE**

Black list: IP address in specified network segment to prohibit access.

White list: IP address in specified network segment to allow access Select a name in the list and click Delete to delete the name from the list. Select a name in the list and click Edit to edit the name in the list. Only one rule type is available, and the last rule type set is efficient.

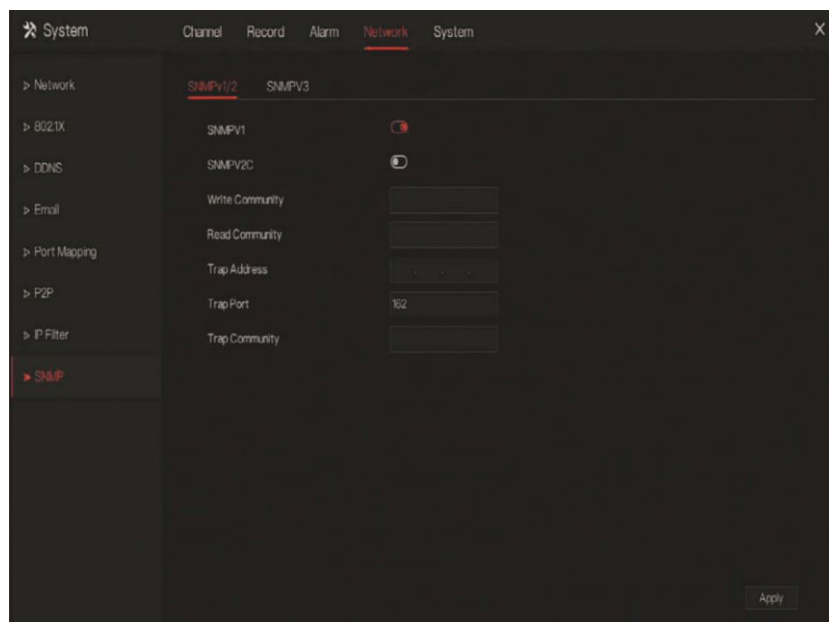
### 7.4.8 SNMP

There are three versions of simple network management protocol at interface.

Operation Steps

Step 1 Click **IP Filter** in the main menu or menu of the network management screen and choose **IP Filter** to access the IP filter screen, as shown in Figure 7-63

Figure 7-63 SNMP settings screen



Operation Steps


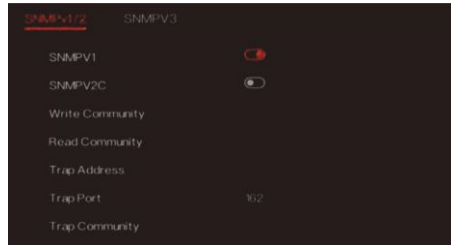
Step 1 Click  next to **SNMPV 1** to enable the function . The interface is shown as Figure 7-64

Figure 7-64 SNMPV 1/2 interface



Step 2 Input the parameters of protocol.

Step 3 Click **Apply** to save settings or click **Cancel** to cancel settings.

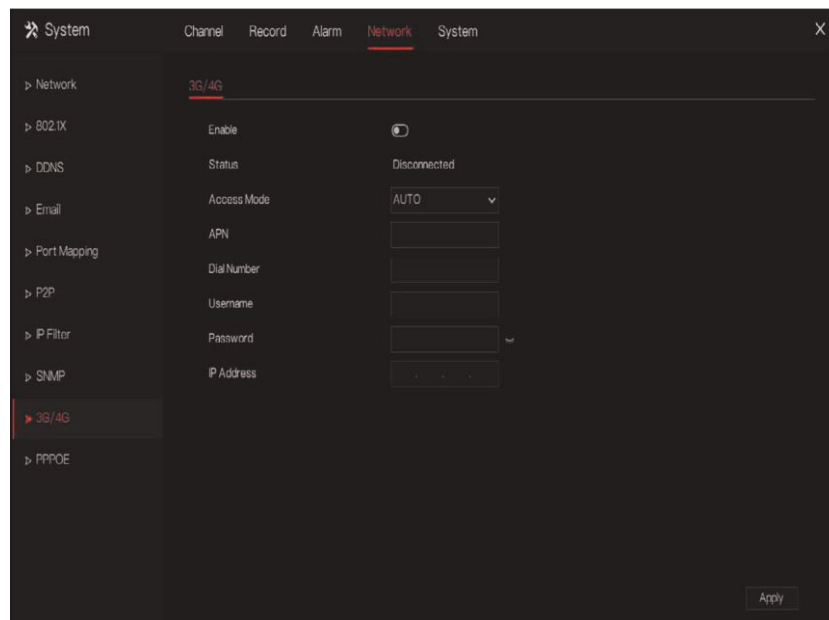
## 7.4.9 3G/4G

User can use modem to connect to data network.

Operation Steps

Step 1 Plug the modem to NVR, and enable the 3G/4G function, as shown in Figure 7-65

Figure 7-65 3G/4G setting screen



Step 2 The status is connected to set the other parameters.

Step 3 Choose access mode, the default is AUTO. There are five modes can be chosen, such as AUTO, LTE, TD-SCDMA, WCDMA, GSM/GPRS.

Step 4 Input the APN, dial number, username, password, IP address. At auto mode, all these parameters can be obtained automatically.

Step 5 Click **Apply** save settings.

**NOTE**

Modify the access mode, if the status is all disconnected in five minutes, please unplug the modem to restart the modem immediately.

Users are familiar with the relevant network (different service provider parameters are different) and modem information before manually switching to other modes, we recommend access mode to choose auto.

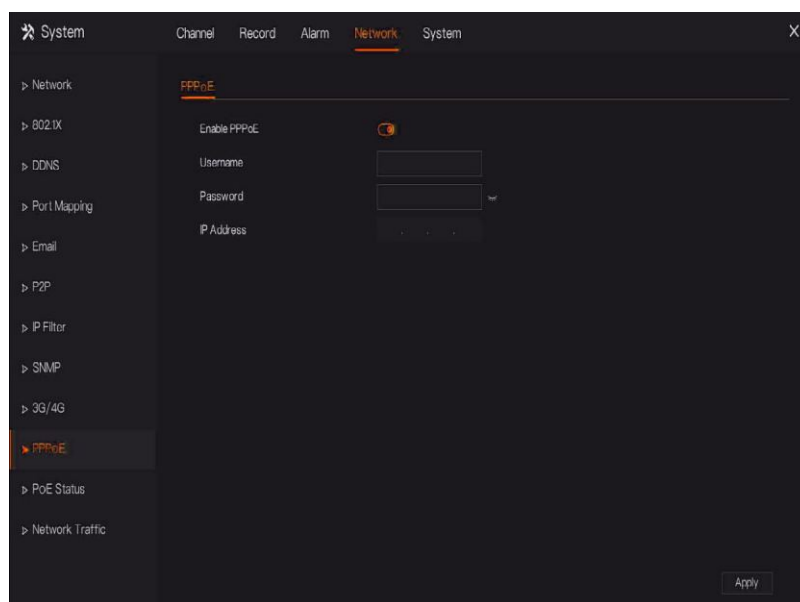
When using the 3G / 4G function, you need to manually close the PPPoE function. Only one function can be used at a time.

If the Internet access type is LTE (4G network), you do not need to dial the number, user name and password.

### 7.4.10 PPPoE

PPPoE point to point protocol Ethernet, user use the PPPoE to access network immediately, as shown in Figure 7-66

Figure 7-66 PPPoE



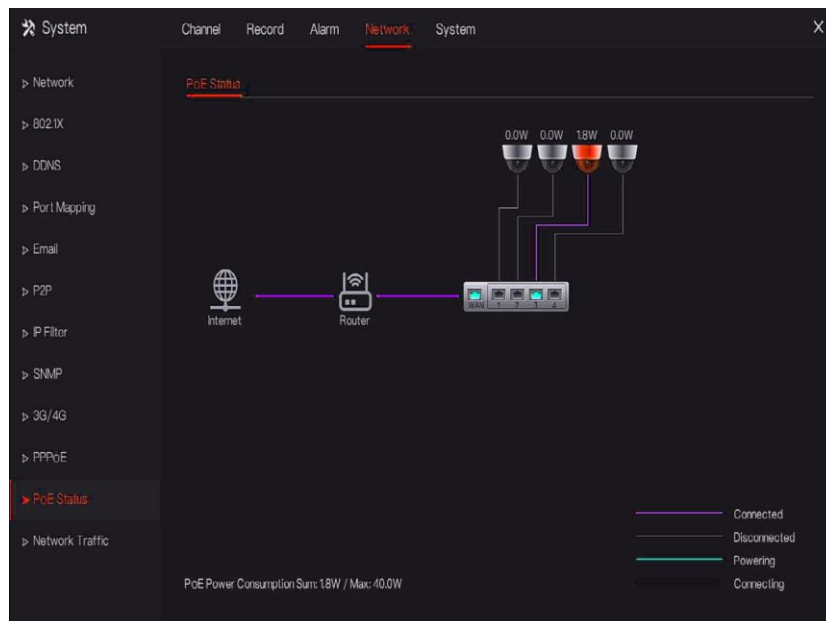
- Step 1 Enable the PPPoE function.
- Step 2 Input the username, password(Network operator provides).
- Step 3 Click **Apply** to save settings, and the IP is obtained automatically.
- Step 4 User input the IP to access NVR web immediately.



### 7.4.11 PoE Status (Only for Some Models)

User can view the status of PoE intuitively, as shown in Figure 7-67

Figure 7-67 PoE Status



There are two rates, transmit rate and receive rate.

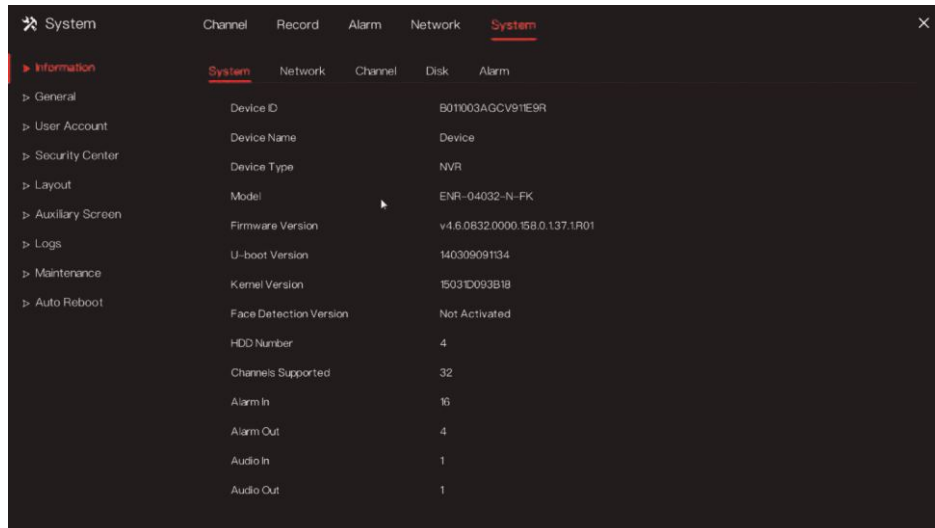
## 7.5 System Management

View the device **Information** and set **General** information, **User Account**, **Security Center**, **Layout**, **Logs**, **Maintenance** and **Auto Reboot** for the system setting.

### Operation Description

Click **System** in the main menu (or click the system page of any function screen in the main menu) to access the system setting screen, as shown in Figure 7-68

Figure 7-68 System setting screen



## 7.5.1 Information

View the device ID, device name, device type, model, firmware version, kernel version, face detection version, HDD volume, channel support, alarm in, and alarm out, audio in, audio out in information screen, as shown in Figure 7-69

Figure 7-69 Information-system interface

|                        |                               |
|------------------------|-------------------------------|
| Device ID              | B011003AGCV91E9R              |
| Device Name            | Device                        |
| Device Type            | NVR                           |
| Model                  | ENR-04032-N-FK                |
| Firmware Version       | v4.6.0832.0000.158.0.137.1R01 |
| U-boot Version         | 140309091134                  |
| Kernel Version         | 15031D093B18                  |
| Face Detection Version | Not Activated                 |
| HDD Number             | 4                             |
| Channels Supported     | 32                            |
| Alarm In               | 16                            |
| Alarm Out              | 4                             |
| Audio In               | 1                             |
| Audio Out              | 1                             |

Network: status, IP address, subnet mask, default gateway, MAC address, DHCP, preferred DNS server, Alternate DNS server, total band width, received packets, and so on, as shown in Figure 7-70

Figure 7-70 Information-network interface

| System               | Network          | Channel | Disk | Alarm |
|----------------------|------------------|---------|------|-------|
| Status               | Online           |         |      |       |
| IP Address           | 192.168.32.69    |         |      |       |
| Subnet Mask          | 255.255.0.0      |         |      |       |
| Default Gateway      | 192.168.32.254   |         |      |       |
| MAC Address          | 00:1E:A4:00:4285 |         |      |       |
| DHCP                 | On               |         |      |       |
| Preferred DNS Server | 192.168.0.1      |         |      |       |
| Alternate DNS Server | 8.8.8.8          |         |      |       |
| Total Bandwidth      | 100.00 Mbps      |         |      |       |
| Received Packets     | 7.76 Mbps        |         |      |       |

Channel: channel, name, status, video format, resolution, bitrate (kbps), and so on, as shown in Figure 7-71

Figure 7-71 Information-channel interface

| System  | Network  | Channel | Disk         | Alarm             |               |
|---------|----------|---------|--------------|-------------------|---------------|
| Channel | Name     | Status  | Video Format | Resolution        | Bitrate(kbps) |
| CH1     | ut       | Online  | H.265/H.264  | 1920*1080/704*576 | 4096/1024     |
| CH2     | Channel2 | Online  | H.265/H.265  | 1920*1080/704*480 | 4096/1024     |
| CH3     | Channel3 | Online  | H.265/H.265  | 1920*1080/104*576 | 4096/1024     |
| CH4     | dfghj    | Online  | H.265/H.265  | 1920*1080/704*480 | 4096/1024     |

Disk: disk name, capacity, used, SN, disk model, status, and so on, as shown in Figure 7-72

Figure 7-72 Information-disk interface

| Channel | Name      | Status | Video Format | Resolution        | Bitrate(kbps) |
|---------|-----------|--------|--------------|-------------------|---------------|
| CH1     | ult       | Online | H.265/H.264  | 1920*1080/704*576 | 4096/1024     |
| CH2     | Channel12 | Online | H.265/H.265  | 1920*1080/704*480 | 4096/1024     |
| CH3     | Channel29 | Online | H.265/H.265  | 1920*1080/704*576 | 4096/1024     |
| CH4     | arghj     | Online | H.265/H.265  | 1920*1080/704*480 | 4096/1024     |

Alarm: channel, name, mode, enable, recording channel, and so on, as shown in Figure 7-74

Figure 7-73 Information-alarm interface

| Channel | Name     | Mode  | Enable | Recording Channel |
|---------|----------|-------|--------|-------------------|
| Lock-1  | Sensor 1 | N/O   | On     |                   |
| Lock-2  | Sensor 2 | N/O   | On     |                   |
| Lock-3  | Sensor 3 | N/O   | On     |                   |
| Lock-4  | Sensor 4 | N/O   | On     |                   |
| Lock-5  |          | Close |        |                   |

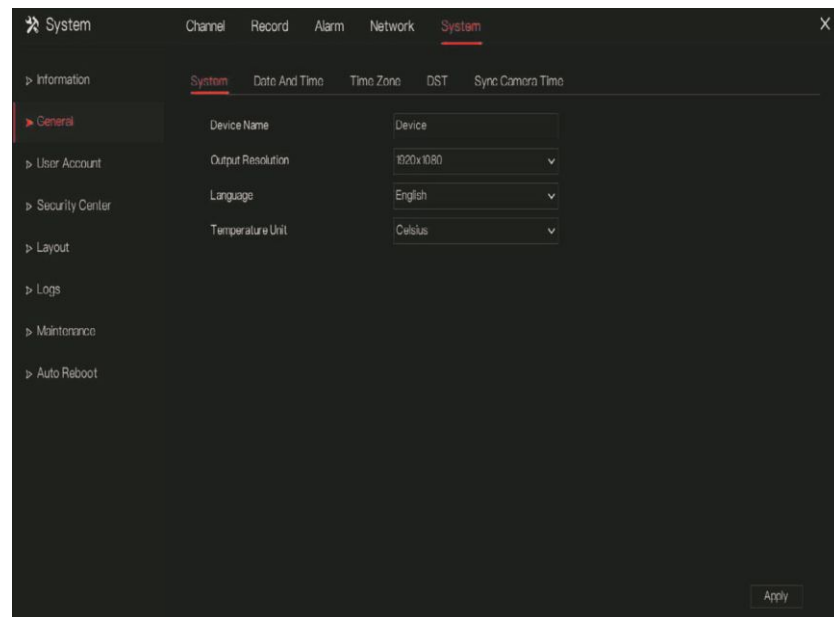
## 7.5.2 General

### 7.5.2.1 System

#### Operation Steps

- Step 1 Click **General** in the main menu or menu of the system management screen and choose **General** to access the system screen, as shown in Figure 7-74

Figure 7-74 system setting screen



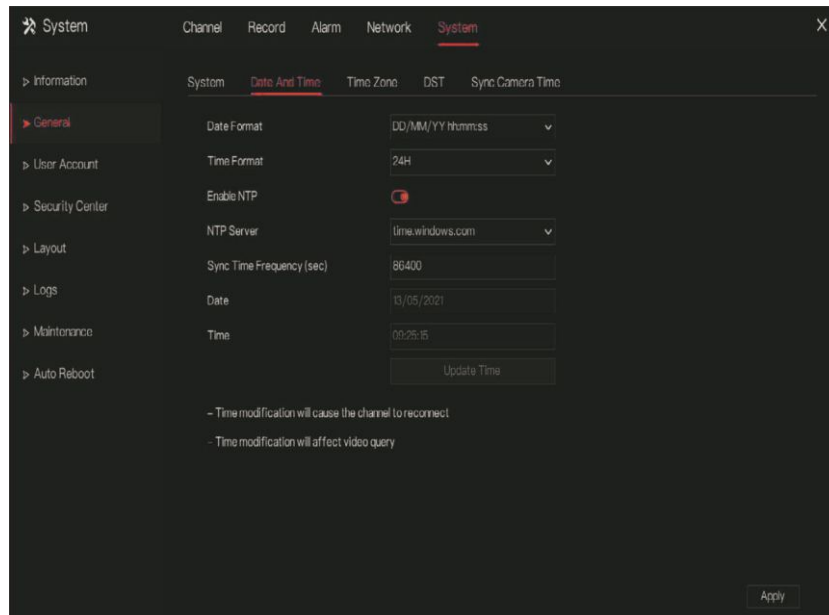
- Step 2 Enter device name for selected device.
- Step 3 Select a proper resolution from the output resolution drop-down list.
- Step 4 Select a required language from the Language drop-down list.
- Step 5 Set the temperature unit.
- Step 5 Click **Apply** to save settings.

### 7.5.2.2 Date & Time

#### Operation Steps

- Step 1 Click **Date and Time** page to access the date and time setting screen, as shown in Figure 7-75

Figure 7-75 Date and Time setting screen



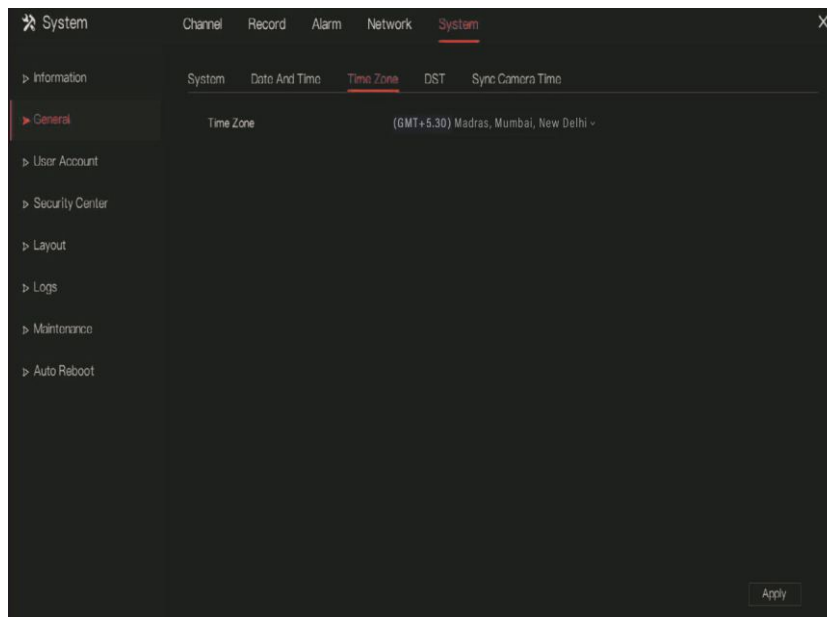
- Step 2 Select required format from the Date Format and time format drop-down list.
- Step 3 Click  next to NTP Sync to disable time synchronization. Time synchronization is enabled by default. Time is synchronized with the NTP.
- Step 4 After NTP Sync is disabled, you can manually set the system time:
  - Click **Date** and scroll the mouse scroll wheel to select the year, month, and date.
  - Click **Time** and scroll the mouse scroll wheel to select the hour, minute, and second.
  - Click **Modify Time** to save the time settings.
- Step 5 Click Apply to save settings.

### 7.5.2.3 Time Zone

#### Operation Steps

- Step 1 Click **Time zone** page to access the time zone setting screen, as shown in Figure 7-76

Figure 7-76 Time zone setting screen



- Step 2 Select a required time zone from the Time Zone drop-down list.
- Step 3 Click **Apply** to save settings.

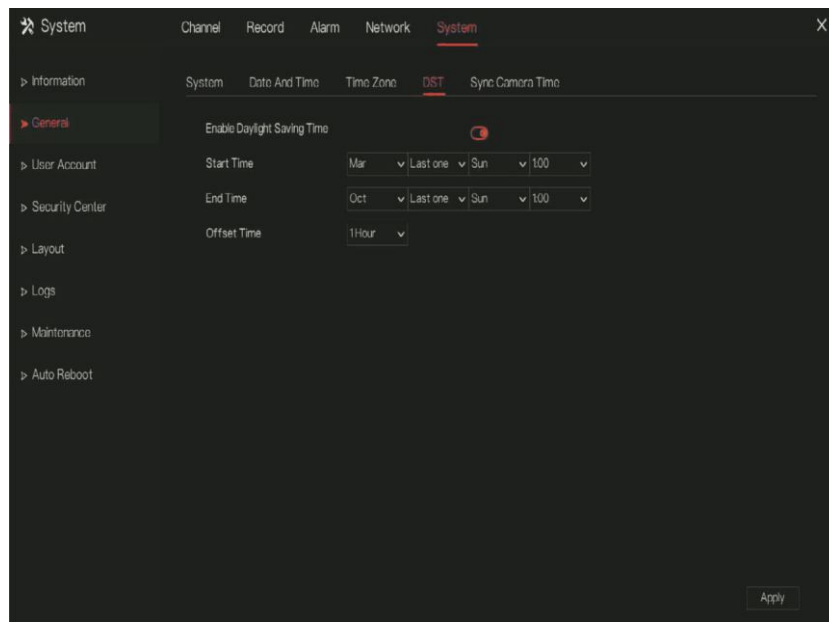
#### 7.5.2.4 DST

When the DST start time arrives, the device time automatically goes forward one hour (offset time). When the DST end time arrives, the device time automatically goes backward one hour. The offset time can change if local rule is different.

#### Operation Steps

- Step 1 Click **DST** page to access the DST setting screen, as shown in Figure 7-77

Figure 7-77 DST setting screen



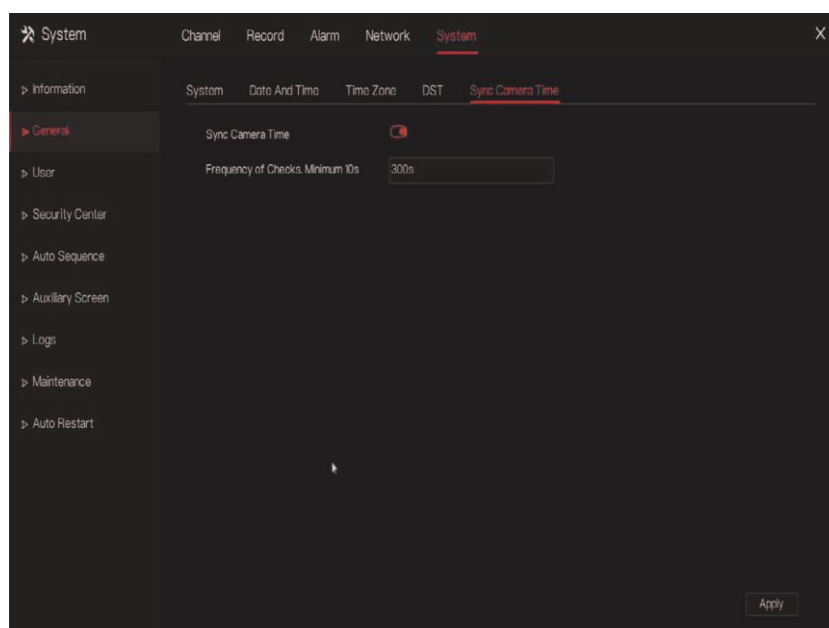
Step 2 Click  next to DST to enable DST.

Step 3 Select start time, end time, offset time from the drop-down list respectively, that basis on the local rules.

Step 4 Click  to save settings.

### 7.5.2.5 Sync Camera Time

User enable the sync camera time, the channels will show the sync time, and can set the frequency of check.





## 7.5.3 User Account

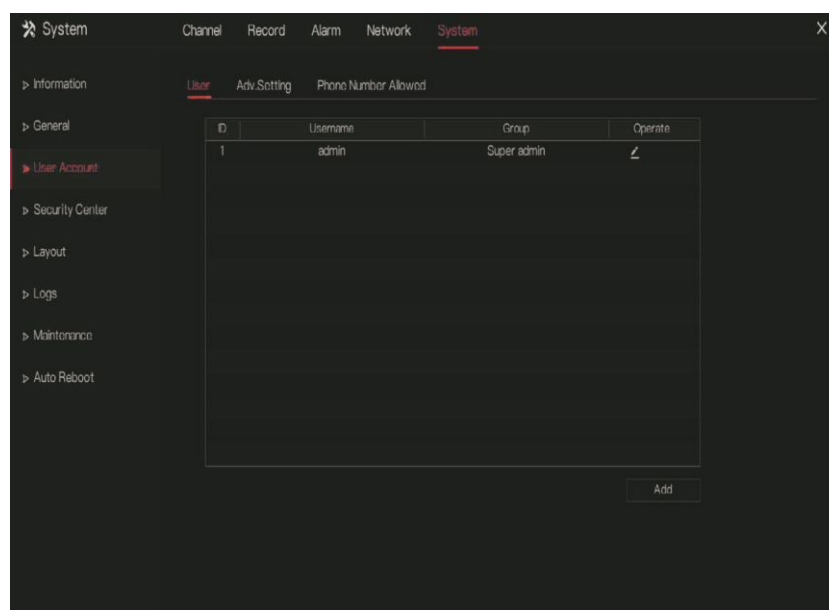
Add, modify, and delete a user and privilege in user screen, admin user can dispose privilege to different user.

### 7.5.3.1 User

#### Operation Steps

Step 1 Click **User** in the main menu or menu of the system management screen and choose **User** to access the user screen, as shown in Figure 7-78

Figure 7-78 User management screen

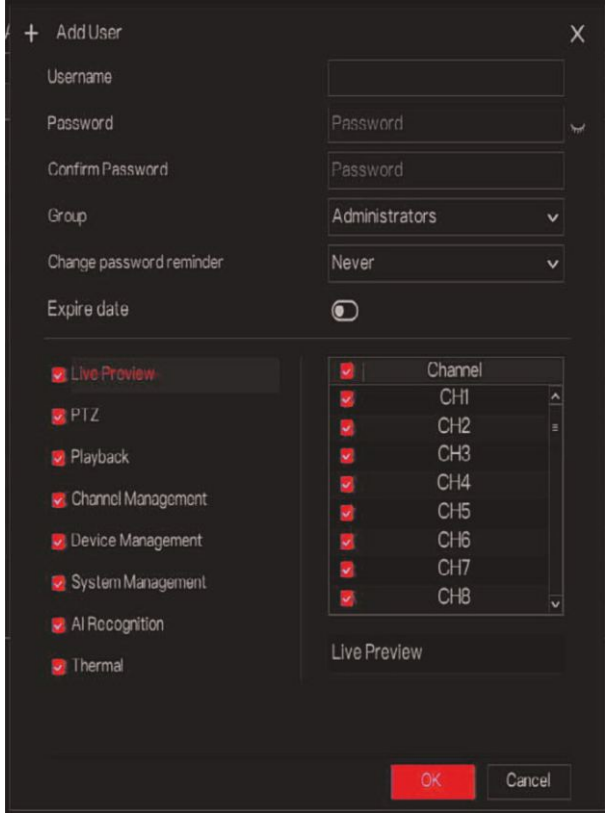


Step 2 Add or delete a user.

- Add a user

Click **Add**, the **Add User** dialog box appears, as shown in Figure 7-79


Figure 7-79 Add user screen





Input a username, password and confirm password, choose group and change password reminder, set the expire date.

 **NOTE**

The password should include letter, character and number, at least two types.  
The password should be 6~32 characters.

- Step 1 Select a Group from the drop-down list box.
- Step 2 Select a Change password reminder value from the drop-down list box.
- Step 3 Enable the expire date to set the new user's authority time.
- Step 4 Select the operation privileges and channels in the list of the add user screen.
- Step 5 Click  The user is set successfully.

 **NOTE**

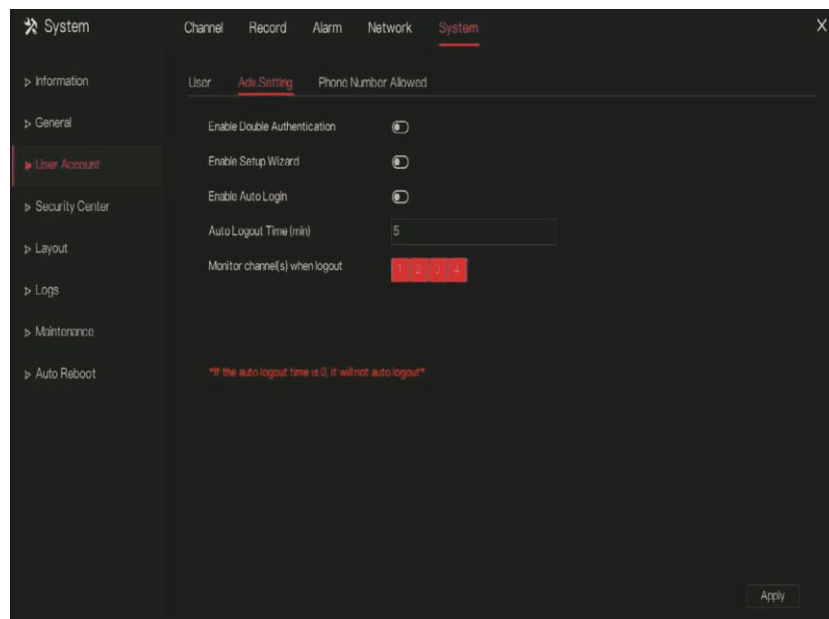
The default user is Administrator and cannot be deleted or modified.  
Select a user from user list and click  to edit, or click  to delete a user.

### 7.5.3.2 Advance Setting

#### Operation Steps

- Step 1 Click **User** in the main menu or menu of the system management screen and choose **Adv Setting** to access the user screen, as shown in Figure 7-80

Figure 7-80 Advance setting screen

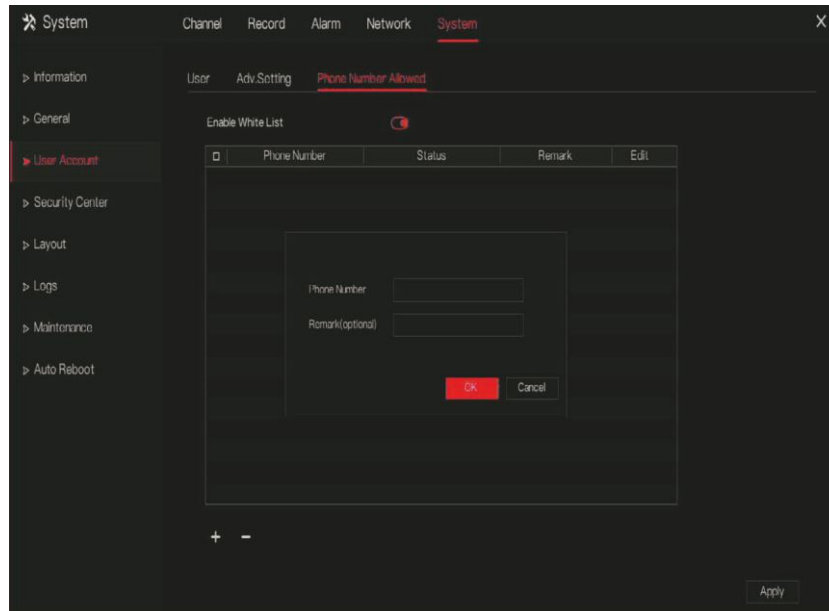


- Step 2 Enable or disable Auto login, Password double authentication, Boot Wizard. Set the logout time if the user disable the auto login.
- Step 3 Choose monitor channels when logout, the default is all channels.
- Step 4 Click **Apply** to save settings.

### 7.5.3.3 App Verification

Add the digital number to white list, when the user login the cellphone App to manage the NVR, it must be input one series number in the white list to test and verify to keep the security.

Figure 7-81 Phone number allowed



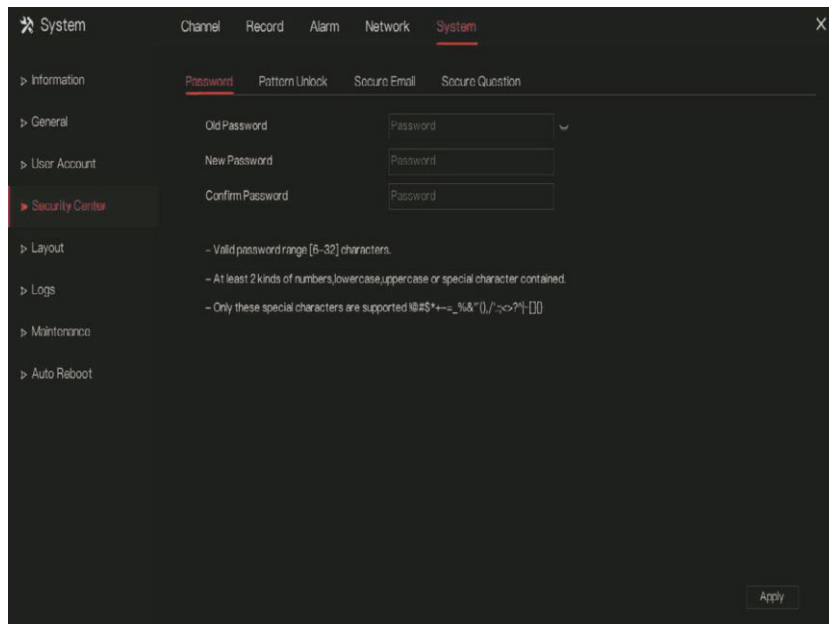
Up to 20 phone numbers can be added, and can modify the remarks for them.  
 Tick the numbers, click "-" to delete the numbers.  
 Click **Apply** to save settings.

### 7.5.3.4 Password

#### Operation Steps

Step 1 Click **Security Center** in the main menu or menu of the system management screen and choose **Password** to access the modify password screen, as shown in Figure 7-82

Figure 7-82 Password modification screen



Step 2 Input the correct old password, new password, and confirm password.

#### NOTE

The password should include at least two kinds of letter, character and number.  
The password should be 6~32 characters.  
Only special characters (! @#&\*+ = - % & " ( ) , / . : ; < > ? ^ | ~ [ ] { }) are supported,

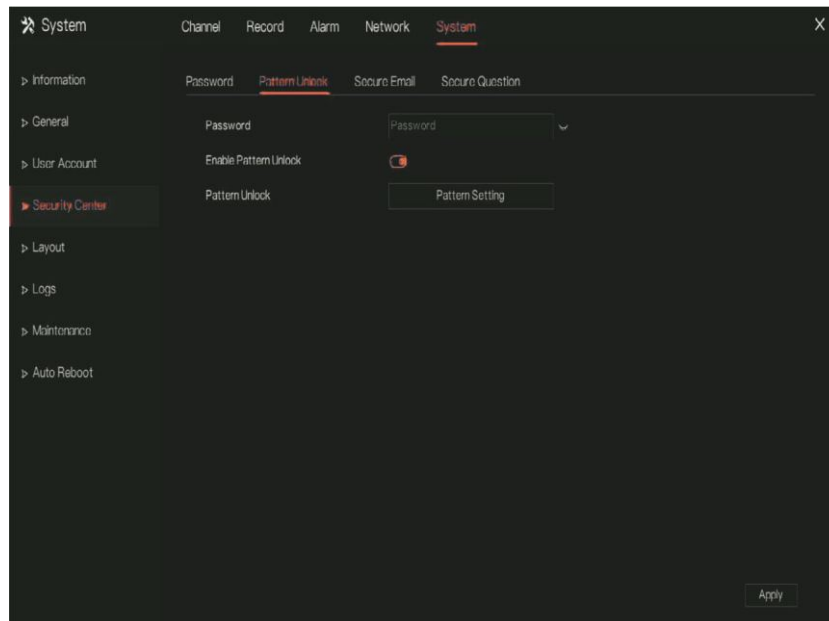
Step 3 Click  to save modified password settings.

### 7.5.3.5 Pattern Unlock

#### Operation Steps

Step 1 Click **Security Center** in the main menu or menu of the system management screen and choose **Pattern Unlock** to access the modify pattern unlock screen, as shown in Figure 7-83

Figure 7-83 Pattern unlock screen

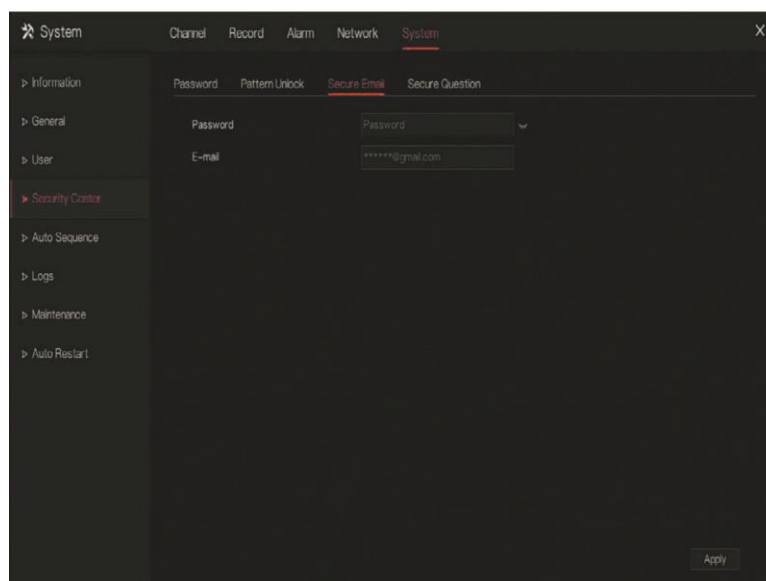


- Step 2 Input the password, enable pattern unlock.
- Step 3 click **Setting Pattern** to set a new pattern unlock.
- Step 4 Draw the pattern, then it will remind to draw the confirmation pattern again.
- Step 5 Click **OK** to save the pattern unlock.

### 7.5.3.6 Secure Email

Set the email to receive the verification code to create new password, as shown in Figure 7-84

Figure 7-84 Secure Email

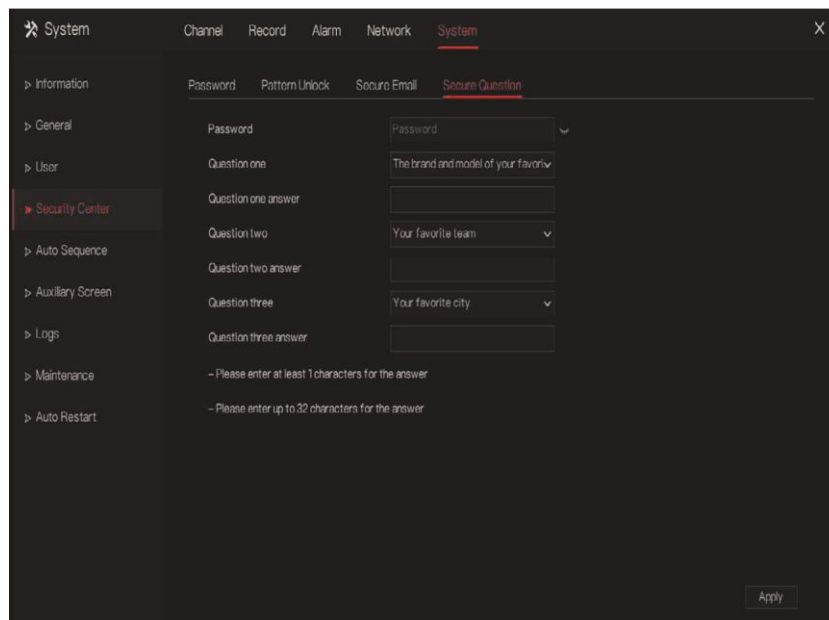


- Step 1 Input the password of NVR.
- Step 2 Set the Email which will receive email of the verification code.
- Step 3 Click **Apply** to save settings

### 7.5.3.7 Secure Question

Set the questions to create new password, as shown in Figure 7-85

Figure 7-85 Secure Question



- Step 1 Input the password of NVR.
- Step 2 Choose the question from drop-down list.
- Step 3 Input the answer, click **Apply** to save setting.

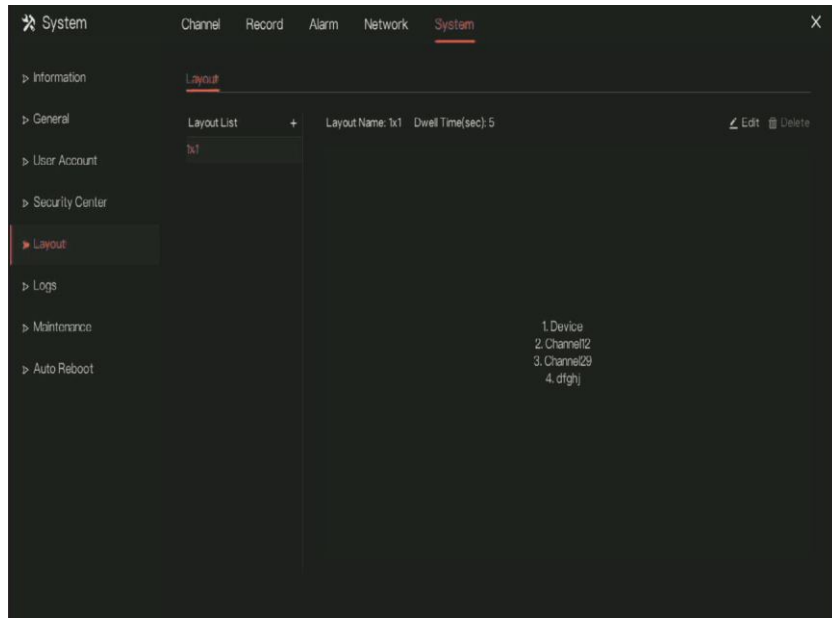
### 7.5.4 Layout

Set viewing video mode, dwell time in display screen. The layout is set multiple pages to auto sequence.

#### Operation Steps

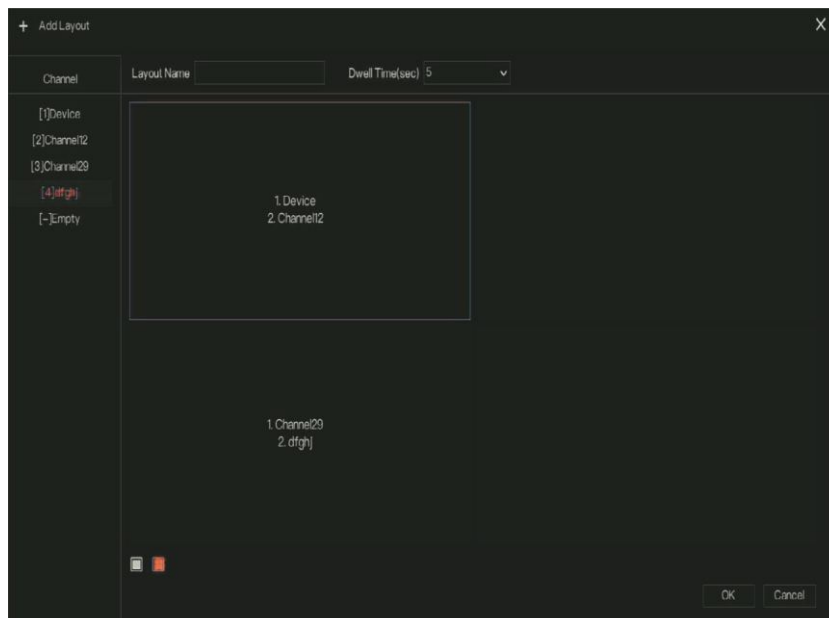
- Step 1 Click **Layout** in the main menu or menu of the system management screen and choose **Layout** to access the display screen, as shown in Figure 7-86

Figure 7-86 Auto Sequence screen




Step 2 Click "+" to add a new layout. The default layout is one splitting screen.

Figure 7-87 Add a new layout.





- Step 3 Input the layout name, select dwell time from the **SEQ** Dwell time drop-down list(the display screen will loop play the real time video according to setting time).
- Step 4 Choose the mode of splitting screen at the page bottom; set the display mode of channels by dragging channel to the specific location, or choose the location first, then click the channels to place. One splitting screen can play several channels, the auto sequence is playing as the set pages, for example the first split screen is set two pages (channel 1 and 2), the second split screen is set one page (channel 3), when enable to auto sequence, the showing is channel 1 and channel 3, then show channel 2 and channel 3.
- Step 5 Click  to save dwell settings.

 **NOTE**

User can add up to 16 layouts.

## 7.5.5 Auxiliary Screen (Only for Some Models)

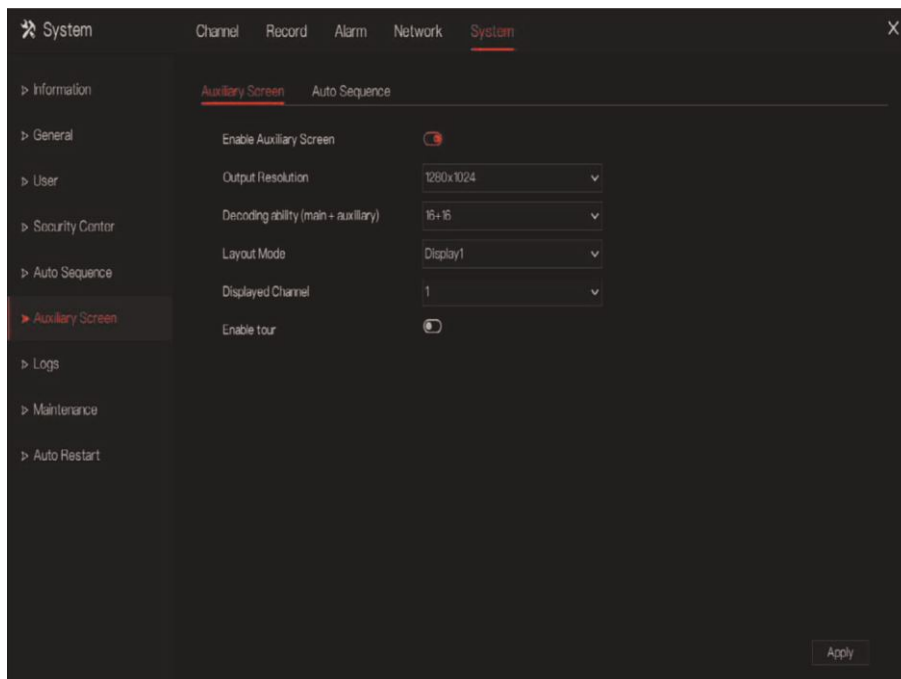
### NOTE

This function only can be used for the devices are 8 or more than channels. The main screen is connected by HDMI (HD-OUT 2), auxiliary screen is connected by VGA.

### Operation Steps

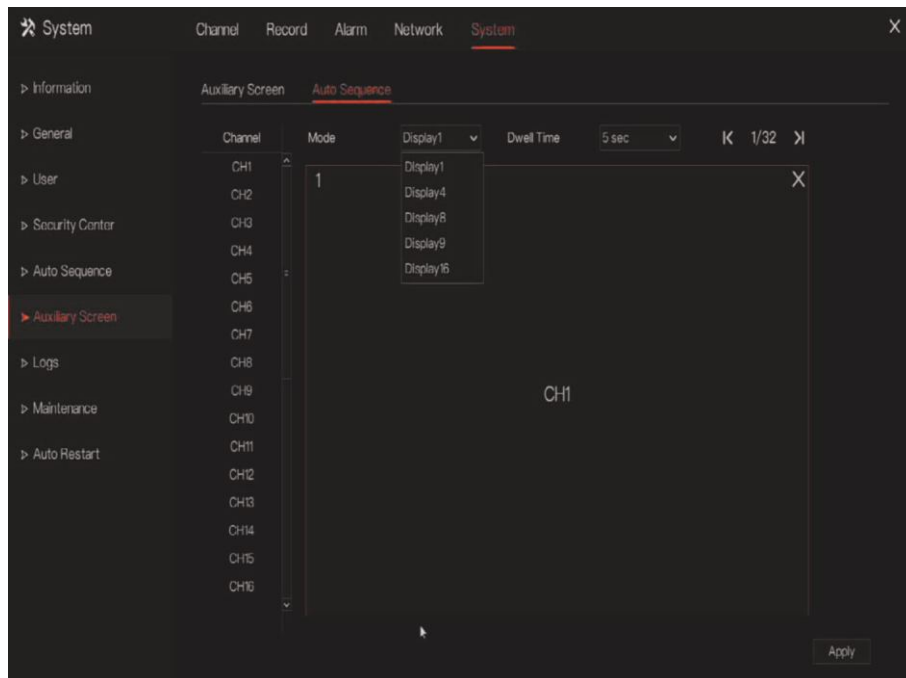
- Step 1 Click **Auxiliary Screen** in the main menu or menu of the system management screen.
- Step 2 Enable the auxiliary screen, as shown in Figure 7-88

Figure 7-88 Auxiliary screen



- Step 3 Set the Output Resolution, Decoding Ability(main + auxiliary), Layout Mode, Display Channel.
- Step 4 Enable tour to set **Auto Sequence** of auxiliary scree as shown in .

Figure 7-89 Auto sequence of auxiliary screen



Step 5 Click **Apply** to save settings.

#### NOTE

The auxiliary screen shows different channels with main screen, and the auto sequence show all channels.  
The auxiliary screen will show the personnel counting information if it is enabling.

## 7.5.6 Logs

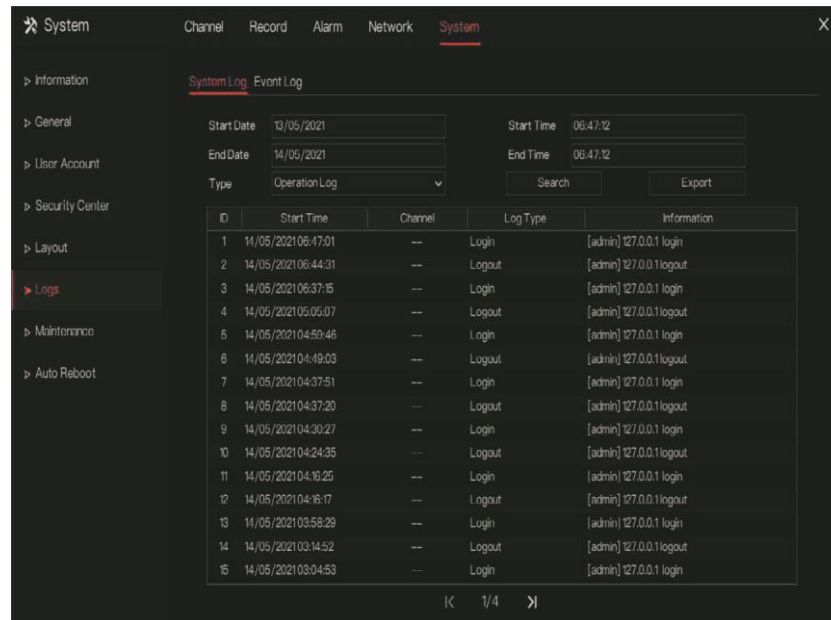
### 7.5.6.1 System Log

Search for logs information and export the information of logs.

#### Operation Steps

Step 1 Click **Logs** in the main menu or menu of the system management screen and choose **Logs** to access the log screen, as shown in 7-90

Figure 7-90 Log screen

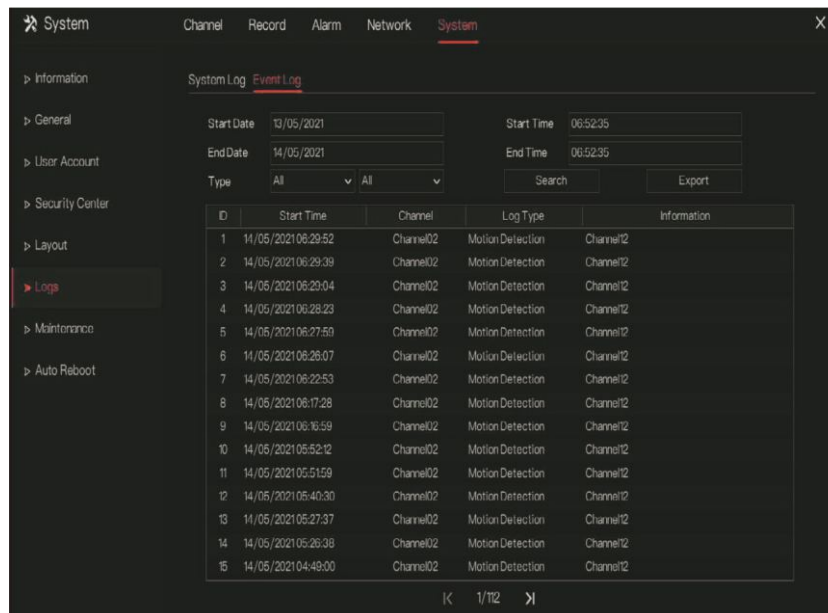


- Step 2 Set the logs start date, end date, start time and end time on log screen.
- Step 3 Select logs type from the drop-down list.
- Step 4 Click **Search** to query logs.
- Step 5 Click **Export** to export logs to flash disk.
- Step 6 the logs can save to flash disk and hard disk at the same time, the newest logs is save to flash disk, and the old logs will be transferred to hard disk.

### 7.5.6.2 Event Log

The event logs are divided to more detail type, user can find the information quickly. The operation is same as system logs, please refer to chapter 7.5.6.1

Figure 7-91 Event

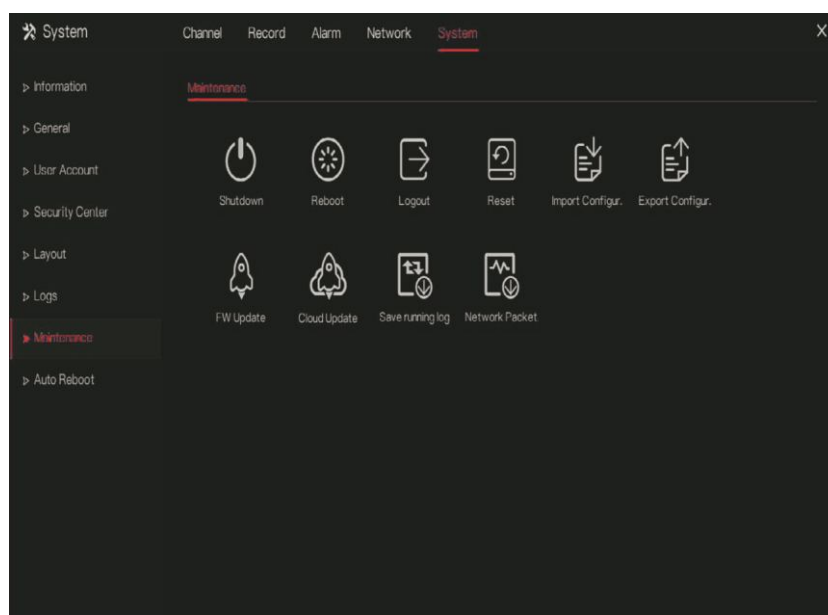


## 7.5.7 Maintenance

### Operation Steps

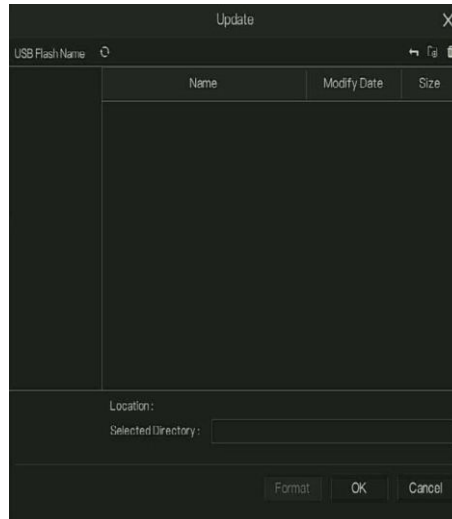
- Step 1 Click **Maintenance** in the main menu or menu of the system management screen and choose **Maintenance** to access the maintenance screen, as shown in Figure 7-92

Figure 7-92 Maintenance screen



- Step 2 Click Shutdown , Reboot , Logout , Exit system , Reset or update to operate NVR if you need.

Figure 7-93 Firmware update



- Step 3 Click import configuration or export configuration to view the message “ **Are you sure to import the configuration?**” user should make flash driver is working.
- Step 4 The tip will show on screen, click ok to ensure choice.
- Step 5 Click **Import Config** to import the configuration to flash drive.
- Step 6 Import the configuration, the device would restart immediately.
- Step 7 Click **Export Config** to export the configuration from flash drive.

#### **NOTE**

When the NVR finishes updating, the device would restart.

Network packet capture: the NVR is plugged the USB disk, click the network packet capture, and set the relevant parameters of the packet capture. The captured data can be downloaded and used for device problem analysis.

FW Update, firmware update; user plug in the U disk with the update software, choose the file to update.

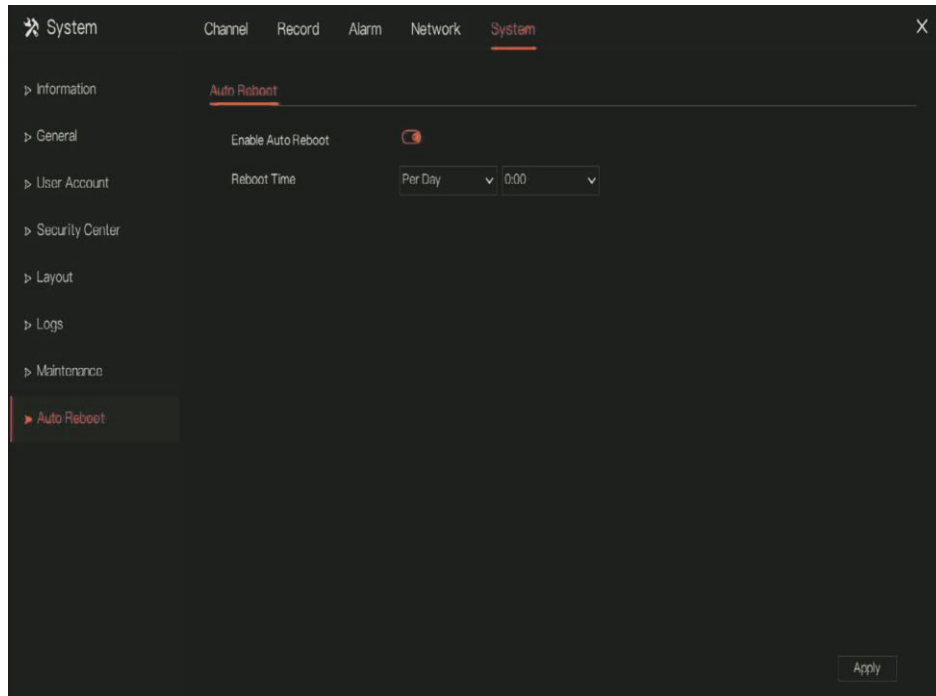
Save running log: user should plug in the U disk to save the running log.

## 7.5.8 Auto Reboot

### Operation Steps

- Step 1 Click **Auto reboot** in the main menu or menu of the system management screen and choose **Auto reboot** to access the maintenance screen, as shown in Figure 7-94

Figure 7-94 Auto restart screen



- Step 2 Enable the function, restart time is showing as figure
- Step 3 Restart the NVR per day, week or month.
- Step 4 Select the restart time from the drop-down list.



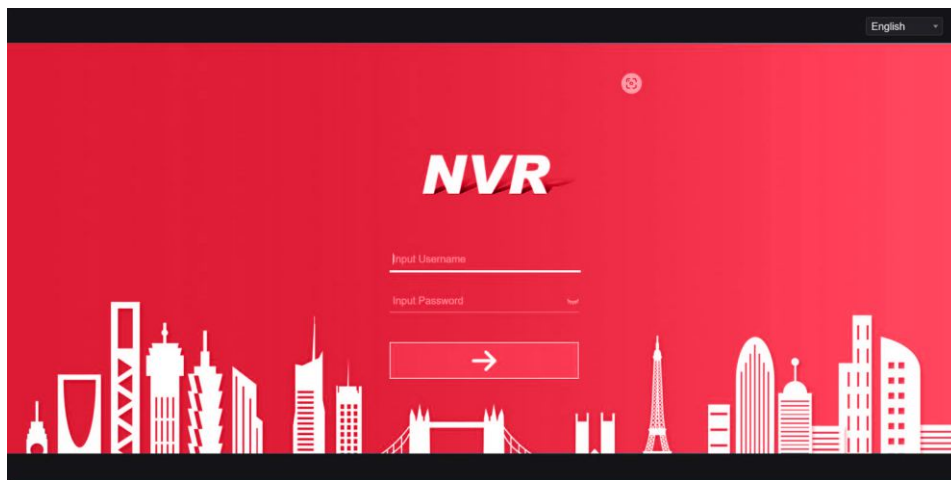
## 8.WEB Quick Start

The functions of Web are another form of UI system setting, all functions can be referred to chapter 7 UI system setting.

### 8.1 Activation

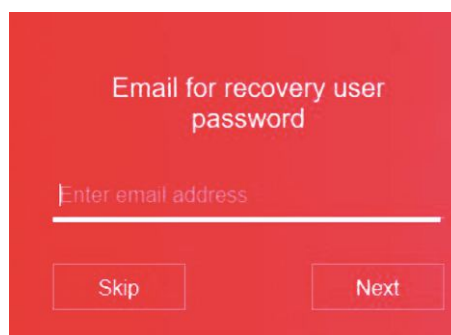
If you don't set the password at UI interface, user need activate the device, as shown in Figure 8-1

Figure 8-1 Activation



- Step 1 Set the password, confirm the password.
- Step 2 Input the channel password.
- Step 3 Set the email of recovery the password.

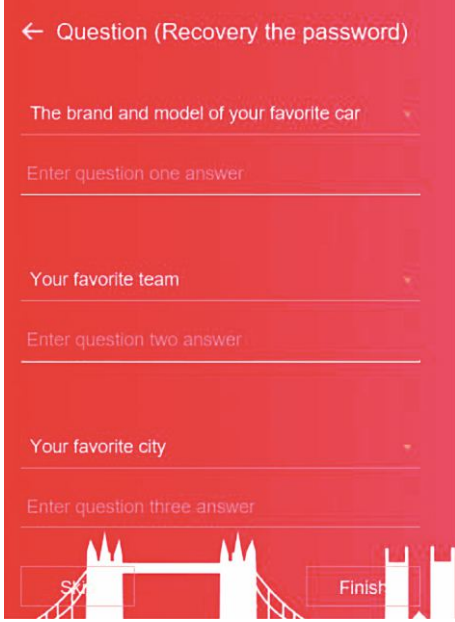
Figure 8-2 Activation



- Step 4 Set the question of recovery the password.



Figure 8-3 Question



 **NOTE**

If you don't to set the email or question, you can skip the steps.

## 8.2 Login and Logout

 **CAUTION**

You must use below Firefox 53 or below Chrome 45 to access the Web interface. Otherwise, the interface functions cannot be used normally. The win 7/ win 10 system supports Firefox/Chorme, but the XP system does not. Brower supports 32 bits.

Descriptions of browser:

To access the client by using Chrome 42-44, you need to enable manually Npapi in the browser according to following steps:

- In the Chrome address bar, enter `chrome://flag/#enable-npapi`.
- Go to the experimental features management page.
- Enable NAPAPI Mac, Windows.
- Click **Enable** (NPAPI plugin is enabled).
- Re-launch Chrome.

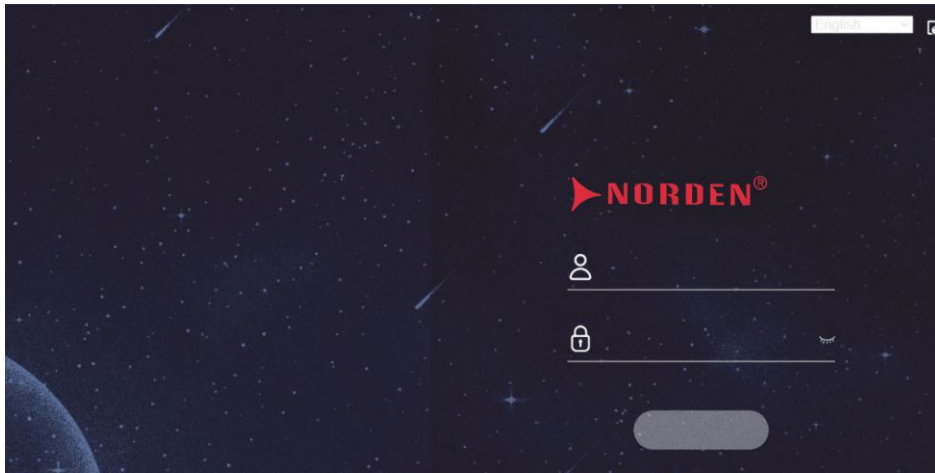
Here we take IE 10 as an example for videos viewing.

## Login

- Step 1 Open IE browser, enter the IP address of the NVR (default value: 192.168.1.200) in the address box, and press **Enter**.

The login page is displayed, as shown in Figure 8-4

Figure 8-4 Login page interface



- Step 2 Input the user name and password.

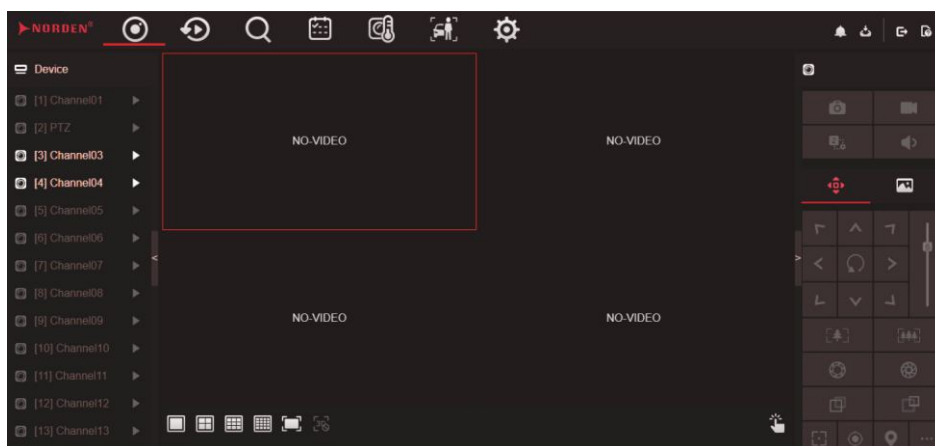
### NOTE

The default user name and password both are admin. The password incorrect more than 3 times, please login again after 5 minutes. User can change the system display language on the login page.


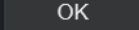
The modify password page pop-up window would show when login the NVR for the first time.

- Step 2 Click Login to access the homepage, as shown in Figure 8-5

Figure 8-5 Homepage interface



## Logout

To logout of the system, click  in the upper right corner of the homepage. The pop-up message shows **"Do you want to exit?"** Click  and the login page will display.

## Homepage Layout

NVR allows you to use the Web interface in a PC for implementation of such functions as live video, playback, retrieval, setting, image parameters access, configuration, PTZ control and so on. Figure 6-7 shows the overall layout of the interface. For descriptions of the interface, please refer to Table 8-1

Figure 8-6 Homepage layout

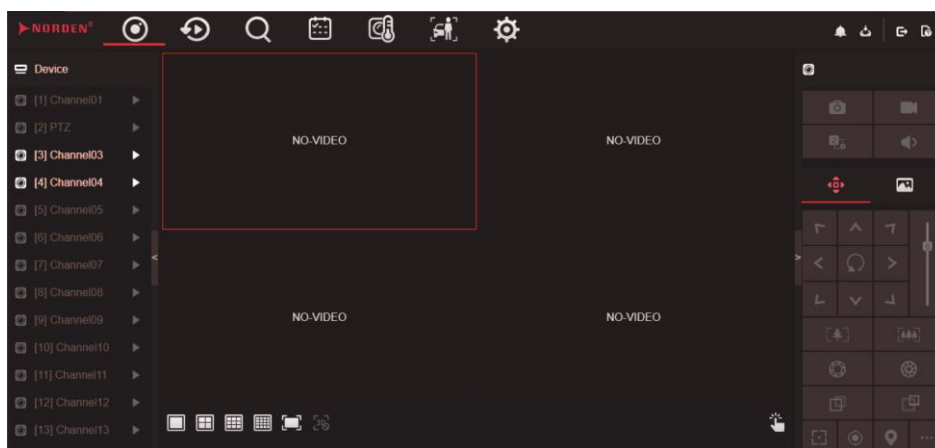




Table 8-1 Descriptions of homepage

| No | Function                | Description   |
|----|-------------------------|---|
| 1  | Function navigation bar | Main functions navigation bar of the device, it includes Live Video, Playback, Alarm Search, Face Recognition, Attendance and System Setting.   |
| 2  | Alarm                   | Alarm notification. User can tick pop-up message to monitor, system alarm and channel alarm.  |
| 3  | Logout button           | User can click Logout to exit the current account and return to the login interface.  |
| 4  | Help                    | Help for running environment, plug-in installation and activation.  |
| 5  | Device's list           | Display a list of the channels of the managed NVR and the channels managed by NVR.  |
| 6  | Real-time video         | Display the real-time videos of the channels managed by NVR.  |
| 7  | Channel Operation       | Include snapshot, record, stream switch and audio on/off.   |
| 8  | PTZ control button      | Click  to show PTZ control buttons in zone 10, you can control the PTZ equipment in the current channels. That function only use for IP dome camera. |

|    |                        |  |
|----|------------------------|--|
| 9  | Color parameter button | Click  to show color parameter setting buttons in zone 9, you can set and adjust the color parameters, for example, brightness, contrast, saturation, and sharpness. Click More to access image settings. |
| 10 | Operation zone         | The operation zone of PTZ control and image parameter setting.   |
| 11 | Layouts                | Select the one-screen, four-screen, nine-screen or sixteen- screen to switch the layout.   |
| 12 | Manual alarm           | Trigger and close the external alarm device manually.  |

## 8.3 Browsing Videos

### 8.3.1 Browsing Real-Time Videos

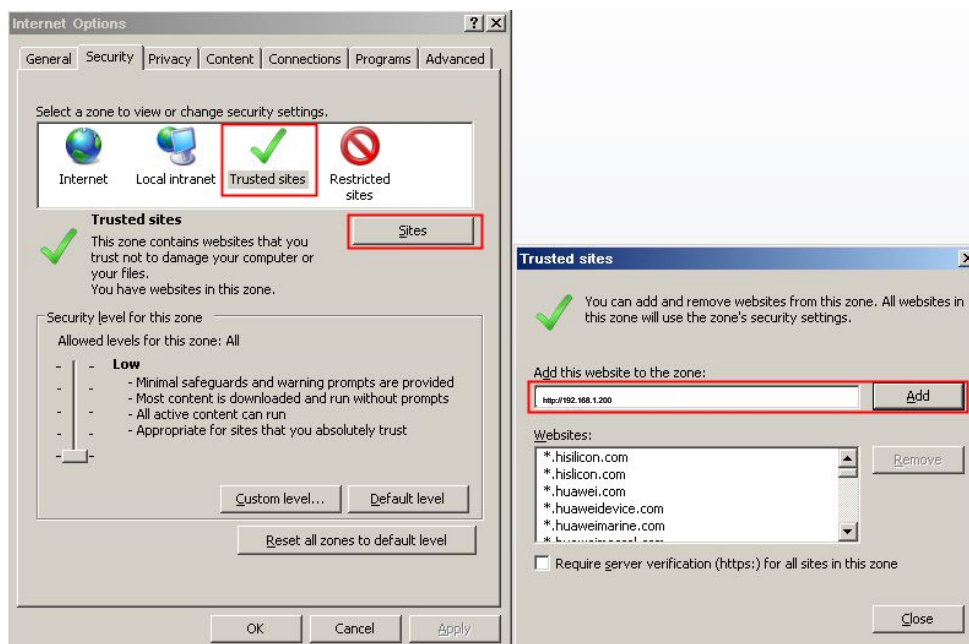
You can browse real-time videos in the web management system.

#### Preparation

To ensure that real-time videos can be played properly, user must perform the following operations when you log in to the web management system for the first time:

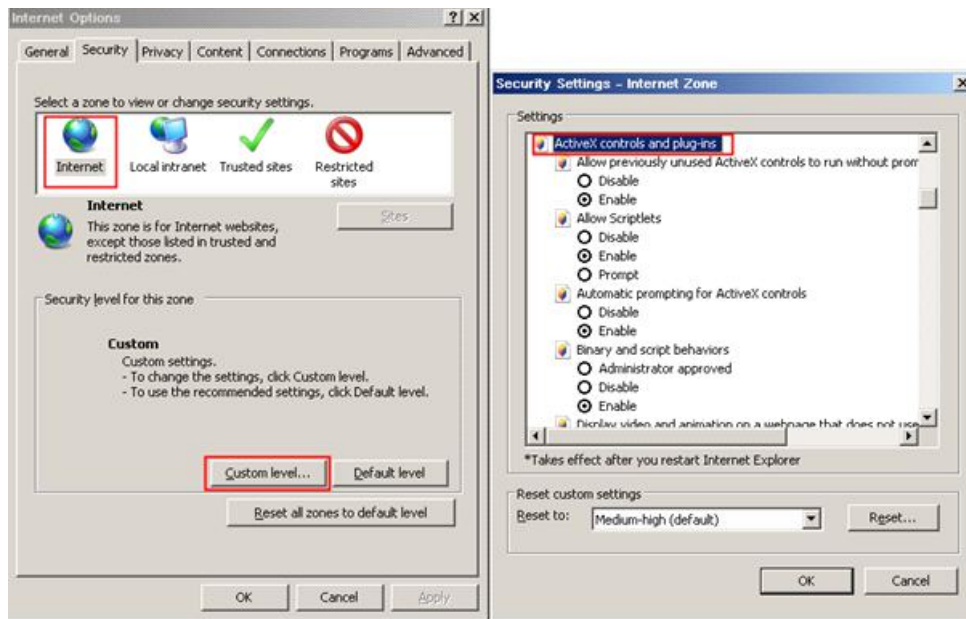
Step 1 Open Internet Explorer. Choose **Tools > Internet Options > Security > Trusted sites > Sites**. In the displayed dialog box, click **Add**, as shown in Figure 8-7

Figure 8-7 Adding a trusted site



Step 1 In Internet Explorer, choose **Tools > Internet Options > Security > Customer level**, and set Download unsignedActiveX controls and Initialize and script ActiveX controls not marked as safe for scripting under ActiveX controls and plug-ins to Enable, as shown in Figure 8-8

Figure 8-8 Configuring ActiveX controls and plug-ins



Step 3 Download and install the player control as prompted. During installing, you need to close the browser.

 **NOTE**

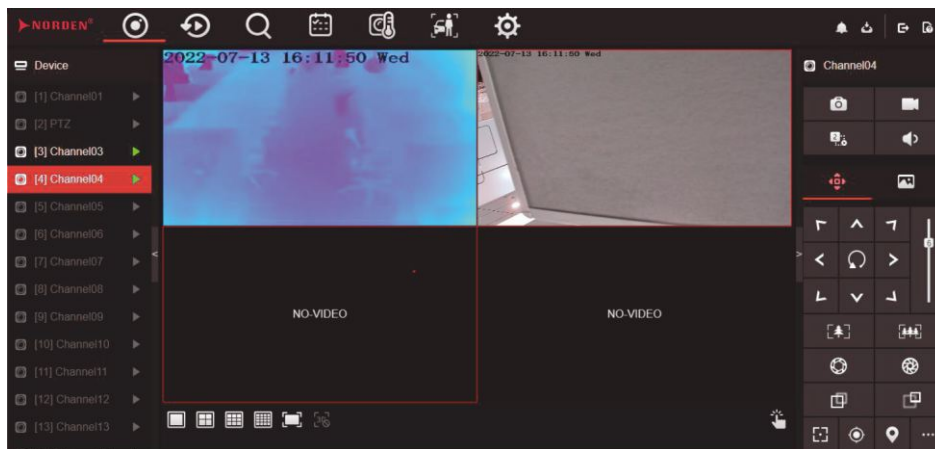
If the repair tips displayed when installing the control , close the browser and continue the installation, reopen the login page when the control is installed.

### 8.3.2 Live Video

#### Descriptions

After login the device, click online channel, you can view the real-time videos, as shown in Figure 8-9

Figure 8-9 Real-time videos interface







### 8.3.3 Channel Operation

#### Descriptions

Channel operation includes snapshot, record, stream switch and audio on/off. Table 8-2 describes the operations.

Table 8-2 Descriptions of homepage

| Buttons   | Button Description   | How to operate  |
|---|----------------------|---|
|  | Snapshot             | Click button to take snapshots of the current image                       |
|  | Record               | Click button to start recording and click button again to stop recording. |
|  | Switch stream        | Click button to switch stream 1 (main stream) and stream 2(sub stream).   |
|  | Enable/Disable video | Click button to enable the audio and click again to disenable the video.  |

### 8.3.4 PTZ Control and Setting

#### Descriptions

The PTZ control and setting function applies only to Network Dome or camera connected to an external PTZ.

#### PTZ Setting

If a Network Dome or a camera connected to PTZ had been added to the NVR channel, user can control the PTZ rotation to adjust their shooting angle when you are viewing the video. This allows you to perform Omni-directional video surveillance.


Click  the PTZ operation and setting interface is displaying, as shown in Figure 8-10. Table 8-3 describes the operations.

Figure 8-10 PTZ control interface

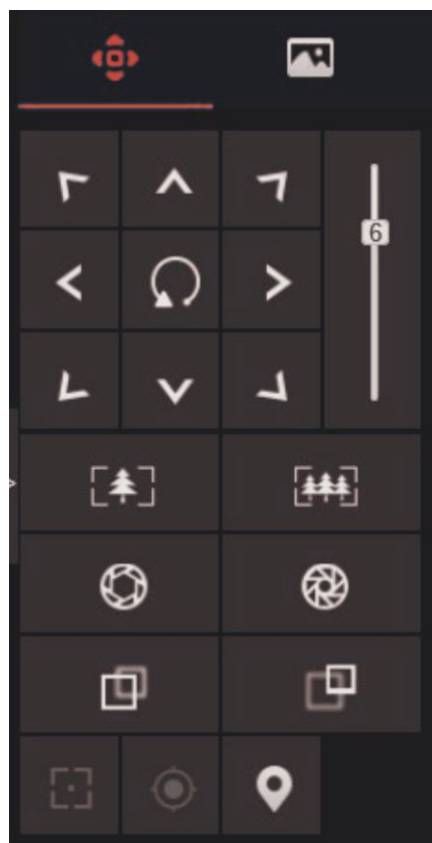














Table 8-3 Device parameters

| Buttons   | Button description | How to operate  |
|---|--------------------|---|
|    | Direction key      | Click button to control omnidirectional movement of the PTZ.                        |
|    | Speed slider       | Drag the slider to adjust the value of PTZ rotation speed.                          |
|    | Zoom in            | Click buttons to adjust the focal length.   |
|    | Zoom out           |   |
|    | Iris+              | Click buttons to adjust the aperture  |
|    | Iris-              |   |
|   | Far focus          | Click buttons to adjust the focal length.   |
|  | Near focus         |   |
|  | Auto focus         | Click button to focus automatically.  |
|  | Home preset        | N/A   |
|  | Preset             | The camera is set the tour, click the button and dome camera rotate as the setting. |
|  | More               | More settings, scan and tour  |

### 8.3.5 Sensor Setting

#### Descriptions

The sensor setting can adjust scene, brightness, sharpness, contrast and saturation, click setting, as shown in Figure 8-11. Table 8-4 describes the operations.



to access image



Figure 8-11 Image parameter interface

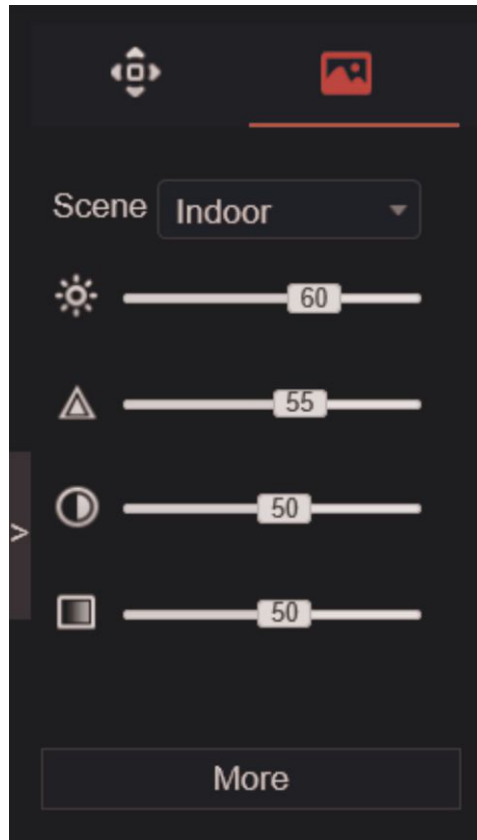




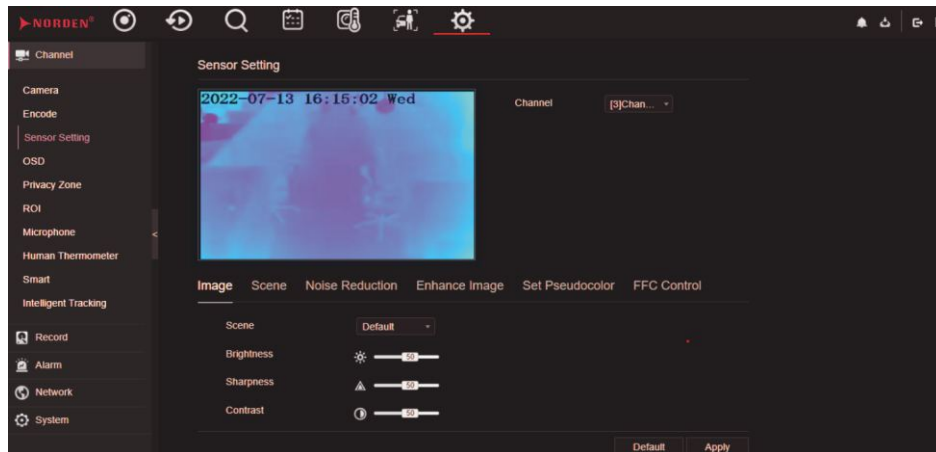


Table 8-4 Device parameters


| Buttons   | Button description | How to operate  |
|---|--------------------|---|
|  | Brightness         | Click button to adjust the image brightness.              |
|  | Sharpness          | Click button to adjust the image definition.              |
|  | Contrast           | Click button to adjust the transparency of the image.     |
|  | Saturation         | Click button to adjust the chromatic purity of the image. |

Click more will be access to system sensor setting. As shown in Figure 8-12 , more detail please refer to chapter Figure 4-7

Figure 8-12 Sensor setting interface



### 8.3.6 Layout

Click  at the bottom left corner of real-time videos interface, the buttons indicate 1 screen, 4 screens and 9 screens from left to right. More PoE port will be 16 screens.

## 8.4 Playback

### 8.4.1 Video Playback

Video playback refers to playing of videos stored in local hard disks.

Procedure


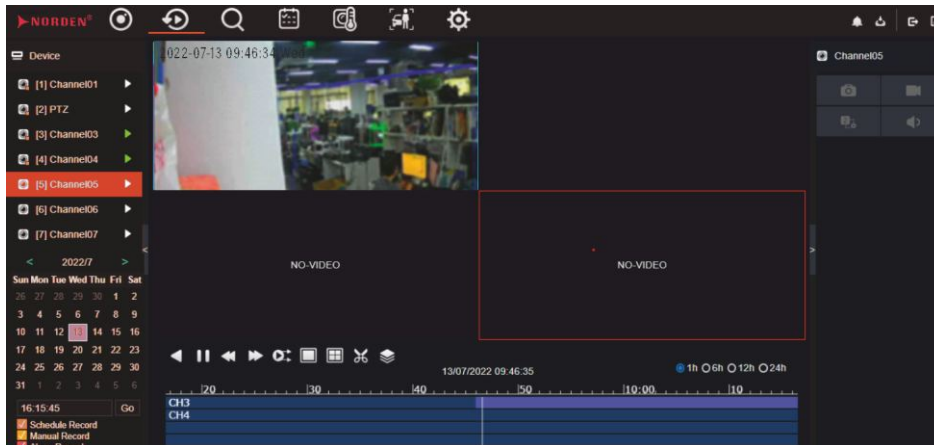


Step 1 Click  in the function navigation bar, the video playback interface is displayed, as shown in Figure 8-13

Figure 8-13 Video playback



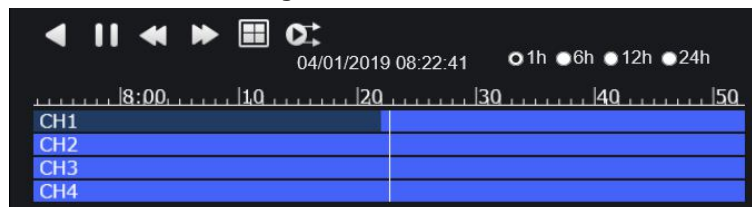
- Step 2 Select a channel. Click a device in the device list. A selected device is marked with . An unselected device is marked with .
- Step 3 Select a date from calendar at left bottom, the date will be colored if it has record as shown in upper figure.
- Step 4 Tick the type of record, such as schedule record, manual record and alarm record.
- Step 5 Display videos.


After a device and date are selected, video information is displayed below the video pane. The time scale above the file axis shows the different time points of video recording. The time in blue in the middle is the time of the video playing. The file axis displays videos. The blue file axis indicates a video exists, grey file axis indicates no video exists. You can drag the axis to play recording quickly.


Step 6 Play a video.


You can play a video after selecting a device and date Figure 8-14 shows the control bar of video playback.


Figure 8-14 Control bar




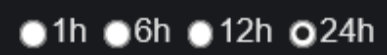
 :reversed.

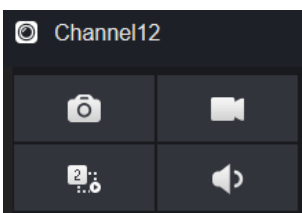
 :play/pause.

 :triple speed.

 :split screen. One or four screens.

 :sync/async. You can set the different channels to play synchronously or asynchronous. Sync mode indicates the selected channels play video synchronously. Async mode indicates user play different time period record

 :types of time bar.



user can operate the record as same as live video.

## 8.5 Alarm Search

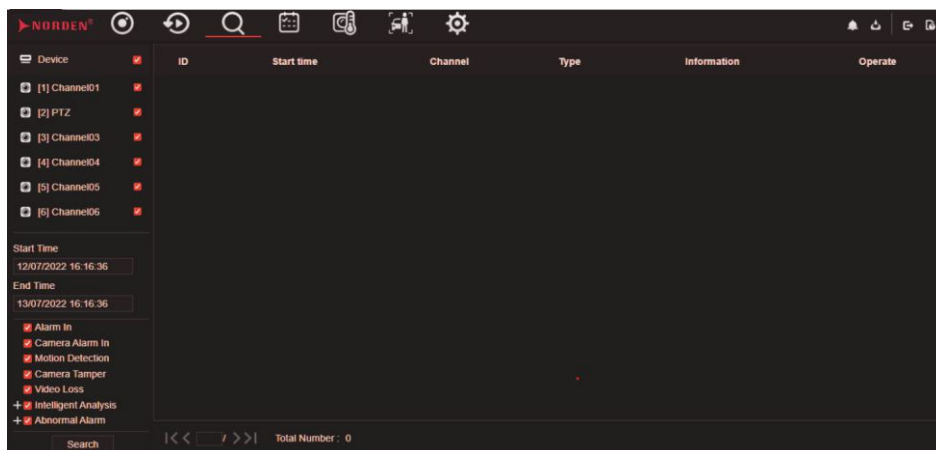
You can search for channel alarm and system alarm in the alarm search interface.

### 8.5.1 Channel Alarm

Procedure

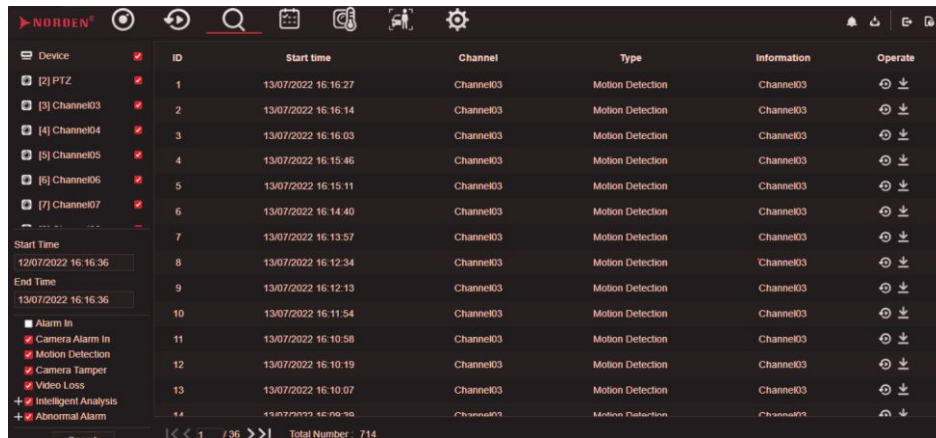
Click  in the function navigation bar, the channel alarm interface is displayed, as shown in Figure 8-15

Figure 8-15 Channel alarm interface



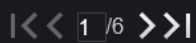
- Step 1 Choose the alarm type to search.
- Step 2 Click Search, the result will be displayed as shown in Figure 8-16

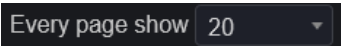
Figure 8-16 Channel alarm result



| Device        | ID | Start time          | Channel   | Type             | Information | Operate |
|---------------|----|---------------------|-----------|------------------|-------------|---------|
| [2] PTZ       | 1  | 13/07/2022 16:16:27 | Channel03 | Motion Detection | Channel03   |         |
| [3] Channel03 | 2  | 13/07/2022 16:16:14 | Channel03 | Motion Detection | Channel03   |         |
| [4] Channel04 | 3  | 13/07/2022 16:16:53 | Channel03 | Motion Detection | Channel03   |         |
| [5] Channel05 | 4  | 13/07/2022 16:15:46 | Channel03 | Motion Detection | Channel03   |         |
| [6] Channel06 | 5  | 13/07/2022 16:15:11 | Channel03 | Motion Detection | Channel03   |         |
| [7] Channel07 | 6  | 13/07/2022 16:14:40 | Channel03 | Motion Detection | Channel03   |         |
|               | 7  | 13/07/2022 16:13:57 | Channel03 | Motion Detection | Channel03   |         |
|               | 8  | 13/07/2022 16:12:34 | Channel03 | Motion Detection | Channel03   |         |
|               | 9  | 13/07/2022 16:12:13 | Channel03 | Motion Detection | Channel03   |         |
|               | 10 | 13/07/2022 16:11:54 | Channel03 | Motion Detection | Channel03   |         |
|               | 11 | 13/07/2022 16:10:58 | Channel03 | Motion Detection | Channel03   |         |
|               | 12 | 13/07/2022 16:10:19 | Channel03 | Motion Detection | Channel03   |         |
|               | 13 | 13/07/2022 16:10:07 | Channel03 | Motion Detection | Channel03   |         |
|               | 14 | 13/07/2022 16:09:56 | Channel03 | Motion Detection | Channel03   |         |

NOTE

Click  to select the page of alarm list.

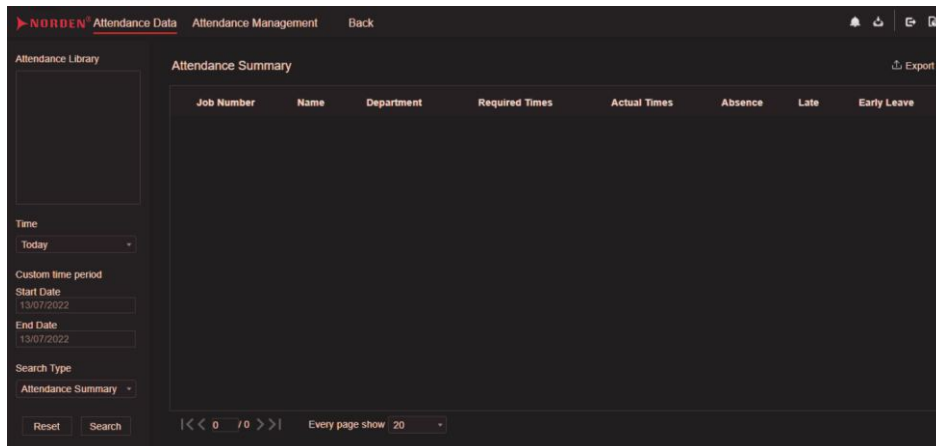
 shows the rows shown in every page.

## 8.6 Attendance (Only for Some Models)

### 8.6.1 Attendance Data

Click to enter attendance data interface, as shown in Figure 8-17

Figure 8-17 Attendance data



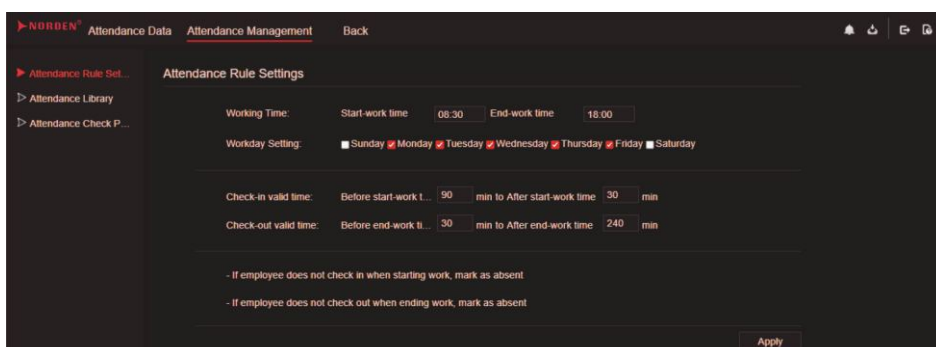
### Operation Steps

- Step 1 Tick the attendance library.
- Step 2 Choose time mode, such as today, this week, this month and custom time.
- Step 3 Choose search type, such as attendance summary and attendance details.
- Step 4 Click search, the result will show in interface.
- Step 5 Click Export to export the query result.

## 8.6.2 Attendance Management

In attendance management, user can set attendance rule, library and check point, as shown in Figure 8-18

Figure 8-18 Attendance rule settings



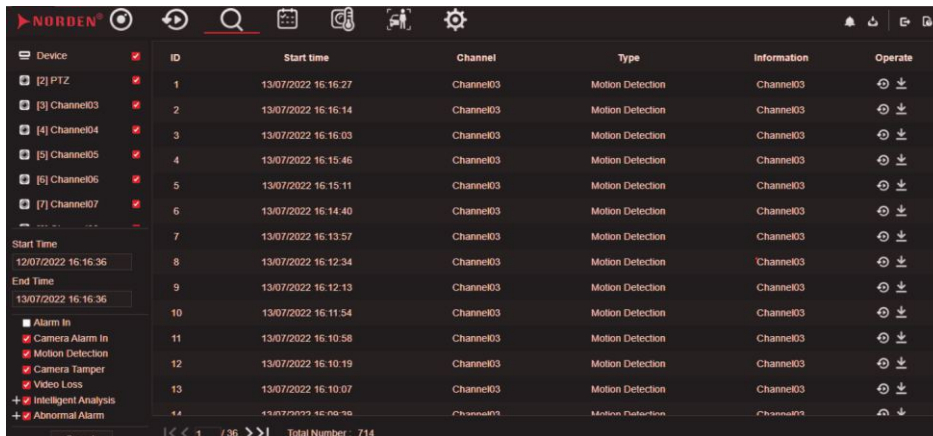
## Operation Steps

- Step 1 Set start work time and end work time.
- Step 2 Tick the workday
- Step 3 Set valid time of check in and check out.
- Step 4 Click Save to save the setting.

## Attendance library

- Step 1 Click **Attendance Library** to add library, the attendance library can call the face database directly.

Figure 8-19 Attendance library



| Device               | ID | Start time          | Channel   | Type             | Information | Operate |
|----------------------|----|---------------------|-----------|------------------|-------------|---------|
| [2] PTZ              | 1  | 13/07/2022 16:16:27 | Channel03 | Motion Detection | Channel03   | 🔄 ⬇️    |
| [3] Channel03        | 2  | 13/07/2022 16:16:14 | Channel03 | Motion Detection | Channel03   | 🔄 ⬇️    |
| [4] Channel04        | 3  | 13/07/2022 16:16:03 | Channel03 | Motion Detection | Channel03   | 🔄 ⬇️    |
| [5] Channel05        | 4  | 13/07/2022 16:15:46 | Channel03 | Motion Detection | Channel03   | 🔄 ⬇️    |
| [6] Channel06        | 5  | 13/07/2022 16:15:11 | Channel03 | Motion Detection | Channel03   | 🔄 ⬇️    |
| [7] Channel07        | 6  | 13/07/2022 16:14:40 | Channel03 | Motion Detection | Channel03   | 🔄 ⬇️    |
| Start Time           | 7  | 13/07/2022 16:13:57 | Channel03 | Motion Detection | Channel03   | 🔄 ⬇️    |
| 12/07/2022 16:16:36  | 8  | 13/07/2022 16:12:34 | Channel03 | Motion Detection | Channel03   | 🔄 ⬇️    |
| End Time             | 9  | 13/07/2022 16:12:13 | Channel03 | Motion Detection | Channel03   | 🔄 ⬇️    |
| 13/07/2022 16:16:36  | 10 | 13/07/2022 16:11:54 | Channel03 | Motion Detection | Channel03   | 🔄 ⬇️    |
| Alarm In             | 11 | 13/07/2022 16:10:58 | Channel03 | Motion Detection | Channel03   | 🔄 ⬇️    |
| Camera Alarm In      | 12 | 13/07/2022 16:10:19 | Channel03 | Motion Detection | Channel03   | 🔄 ⬇️    |
| Motion Detection     | 13 | 13/07/2022 16:10:07 | Channel03 | Motion Detection | Channel03   | 🔄 ⬇️    |
| Camera Tamper        | 14 | 13/07/2022 16:09:36 | Channel03 | Motion Detection | Channel03   | 🔄 ⬇️    |
| Video Loss           |    |                     |           |                  |             |         |
| Intelligent Analysis |    |                     |           |                  |             |         |
| Abnormal Alarm       |    |                     |           |                  |             |         |

- Step 2 Tick the library and click **Add** to add to attendance library. If you want to modify the library, please enter to library interface to change parameters..

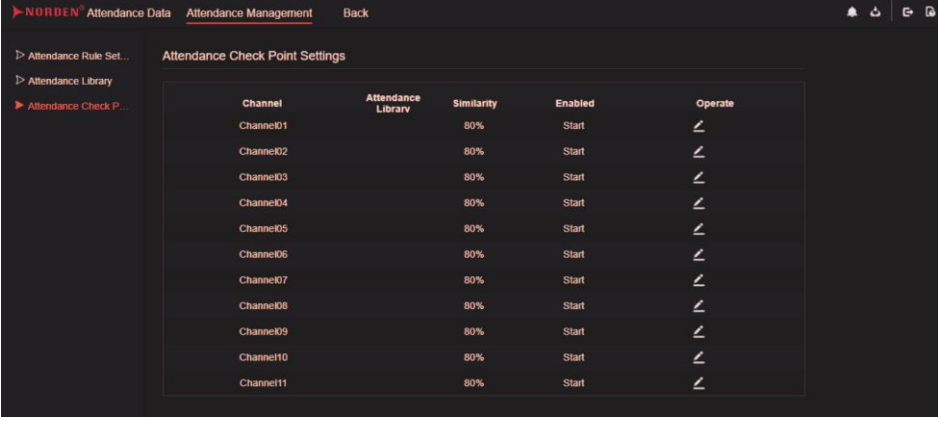
- Step 3 Click  **Database management** to enter the face database management to modify parameter.

- Step 4 Click **Save** to save the setting.

## Attendance check point settings:

- Step 1 Click Attendance check point settings to set point, as shown in Figure 8-20

Figure 8-20 Attendance check point setting



| Channel   | Attendance Library | Similarity | Enabled | Operate |
|-----------|--------------------|------------|---------|---------|
| Channel01 |                    | 80%        | Start   | ↙       |
| Channel02 |                    | 80%        | Start   | ↙       |
| Channel03 |                    | 80%        | Start   | ↙       |
| Channel04 |                    | 80%        | Start   | ↙       |
| Channel05 |                    | 80%        | Start   | ↙       |
| Channel06 |                    | 80%        | Start   | ↙       |
| Channel07 |                    | 80%        | Start   | ↙       |
| Channel08 |                    | 80%        | Start   | ↙       |
| Channel09 |                    | 80%        | Start   | ↙       |
| Channel10 |                    | 80%        | Start   | ↙       |
| Channel11 |                    | 80%        | Start   | ↙       |


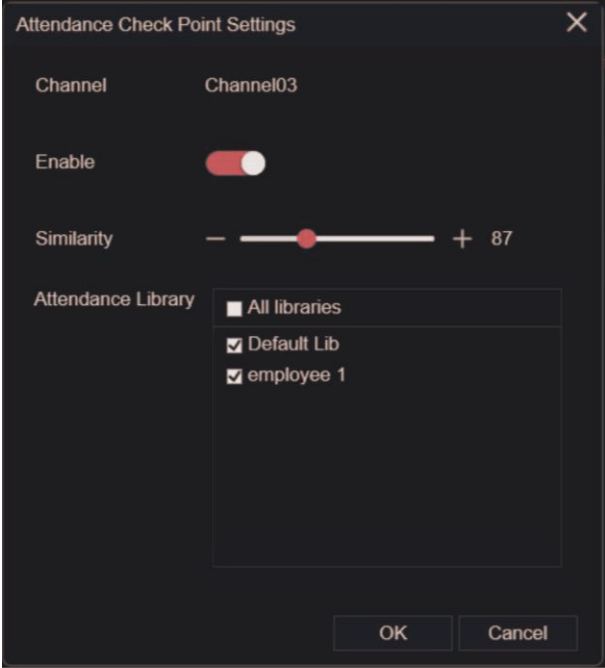
Step 2 Click  to edit check point setting, as shown in Figure 8-21

Figure 8-21 Check point



Attendance Check Point Settings

Channel: Channel03

Enable:

Similarity:  87

Attendance Library:

- All libraries
- Default Lib
- employee 1

OK Cancel

Step 3 Enable the function, set similarity and tick the library, all face detection cameras can be set the check points

Step 4 Click OK to save the setting.



## 8.7 AI Recognition (Only for Some Models)

At AI recognition interface, we can set the **Real time Comparison, Smart search, Archives library, Comparison configuration.**

### 8.7.1 Real Time Comparison

Real time comparison can compare human face, vehicle license plate, and AI(include riding, vehicle, full body )

#### 8.7.1.1 Human Face


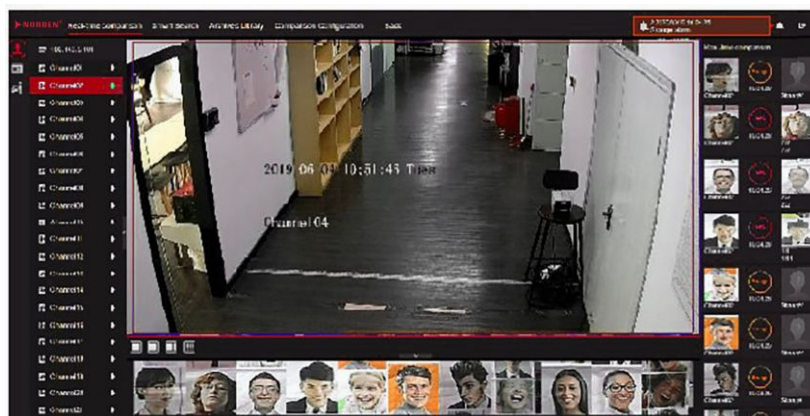
At real time comparison interface, click the  to enter the human face comparison interface, choose the cameras with face recognition function to play live video, the snapshot of camera will compare with libraries, the result shows as in Figure 8-22

Figure 8-22 Human face comparison



Click the "+" can add the snapshot to face library immediately.

#### 8.7.1.2 Vehicle License Plate


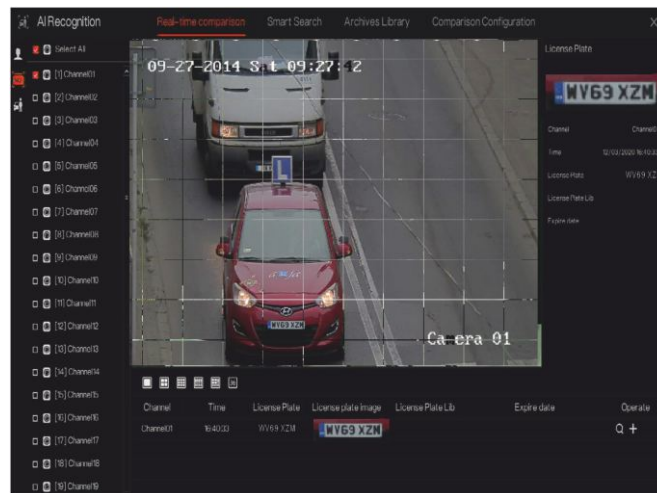

At real time comparison interface, click the  to enter the vehicle license plate comparison interface, choose the cameras with license plate recognition function to play live video, the snapshot of camera will compare with libraries, the result shows as in Figure 8-22

Figure 8-22 Vehicle license plate



Click the "+" can add the snapshot to license plate library immediately.

Snapshot in real time video, put the cursor on picture such as , you can add it to face library, or face search. The cursor on area 6 and the pictures is not update, move the mouse so that the pictures can be shown in time.

### 8.7.1.3 Vehicle and Full Body


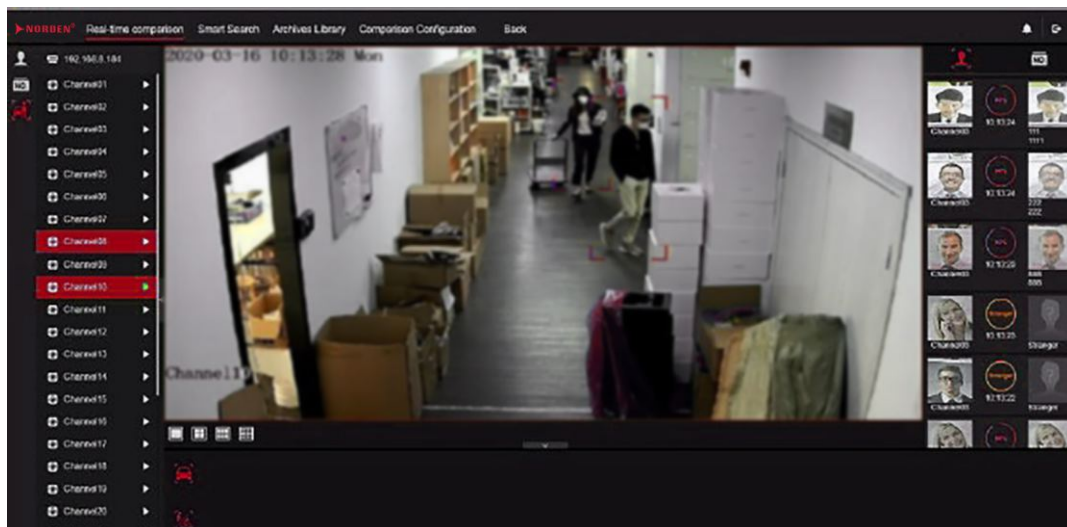
At real time comparison interface, click the  to enter the vehicle license plate comparison interface, choose the AI recognition cameras to play live video, the snapshot of camera will compare with libraries, the snapshot to vehicle and full body will show at the bottom of page, the result shows as in Figure 8-24.

Figure 8-23 Full body



### 8.7.1.4 Real Time Body Temperature Filter


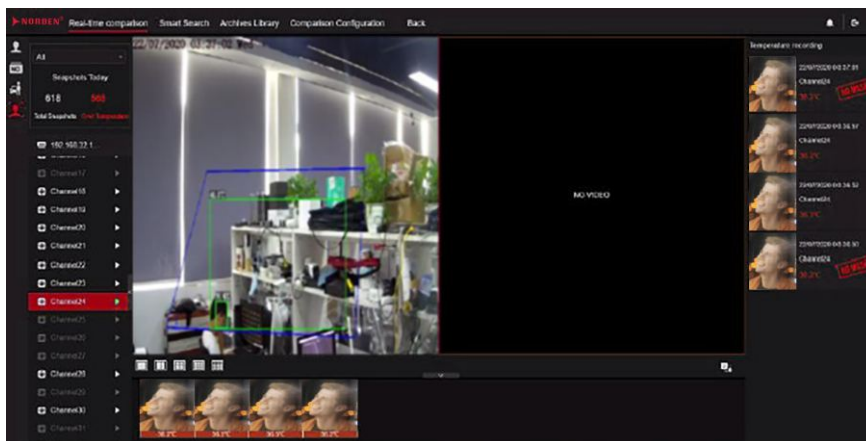
The real time body temperature will show the snapshot of device, it shows the over temperature and snapshot to human face. Snapshot will show the char such as no mask (the mask detection configuration can be set at comparison configuration interface )

Figure 8-24 Body temperature



## 8.7.2 Smart Search

At smart search interface, user can search the human face, vehicle license plate, full body, car, body temperature.

### 8.7.2.1 Human Face Search

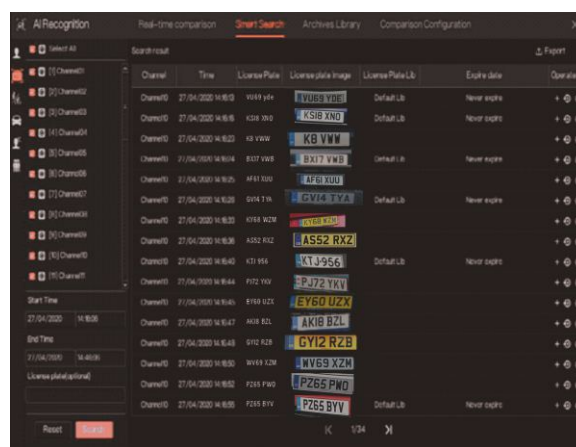
Figure 8-25 Human face search



- Step 1 Choose human face search at smart search interface.
- Step 2 Tick the face recognition camera channels, set the start time and end time.
- Step 3 Choose the condition (by picture or by feature), the picture can choose from the file folder.
- Step 4 Click "Search" to search the snapshot of human face.
- Step 5 The result will show at the middle of page, click the picture and the detail information show at the top right of page.
- Step 6 The detail picture can be used to search or add to library.
- Step 7 Click play button of video to play the recording of snapshot.

### 8.7.2.2 Vehicle License Plate Search

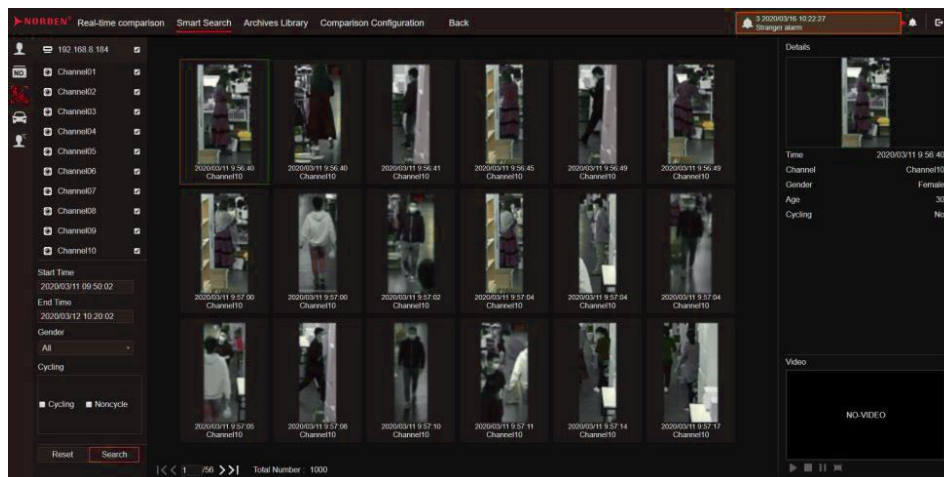
Figure 8-26 Vehicle License Plate search



- Step 1 Choose vehicle License Plate at smart search interface.
- Step 2 Tick the vehicle license plate recognition camera channels, set the start time and end time.
- Step 3 Input the license plate optionally.
- Step 4 Click "Search" to search the snapshot of license plate.
- Step 5 The result will show at the page, click "+" add to library.

### 8.7.2.3 Full Body Search

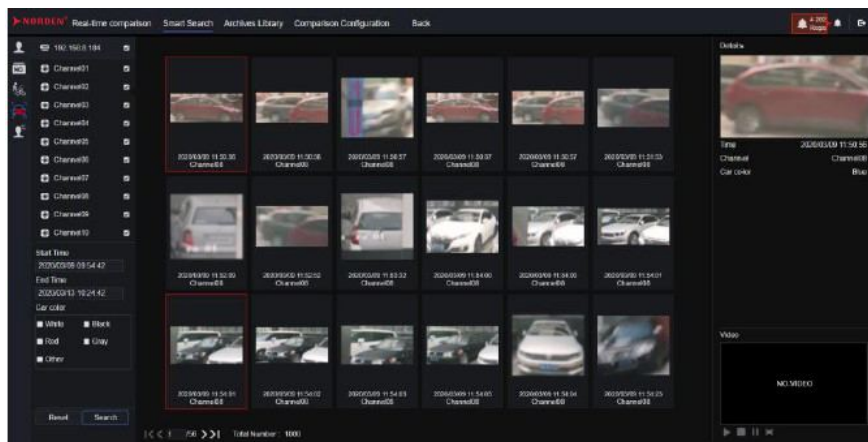
Figure 8-27 Full body search



- Step 1 Choose full body search at smart search interface.
- Step 2 Tick the AI recognition camera channels, set the start time and end time.
- Step 3 Set the gender, click cycling or no cycling .
- Step 4 Click "Search" to search the snapshot of human face.
- Step 5 The result will show at the middle of page, click the picture and the detail information show at the top right of page.
- Step 6 Click play button of video to play the recording of snapshot.

### 8.7.2.3 Vehicle Search

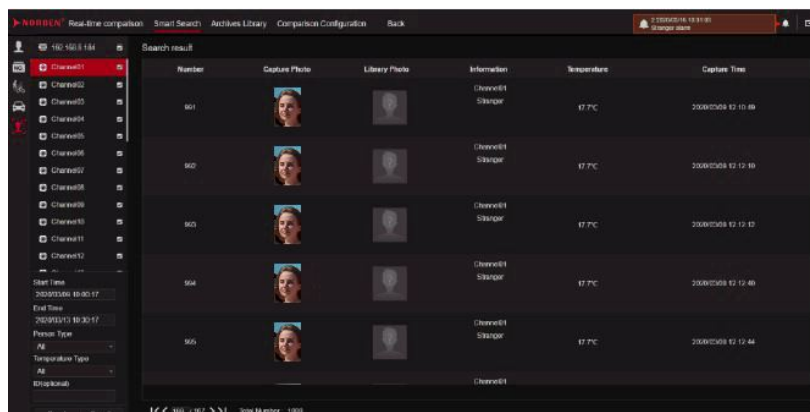
Figure 8-28 Vehicle search



- Step 1 Choose vehicle search at smart search interface.
- Step 2 Tick the AI recognition camera channels, set the start time and end time.
- Step 3 Tick the color
- Step 4 Click "Search" to search the snapshot of human face.
- Step 5 The result will show at the middle of page, click the picture and the detail information show at the top right of page.
- Step 6 Click play button of video to play the recording of snapshot.

### 8.7.2.5 Body Temperature Search

Figure 8-29 Body temperature search

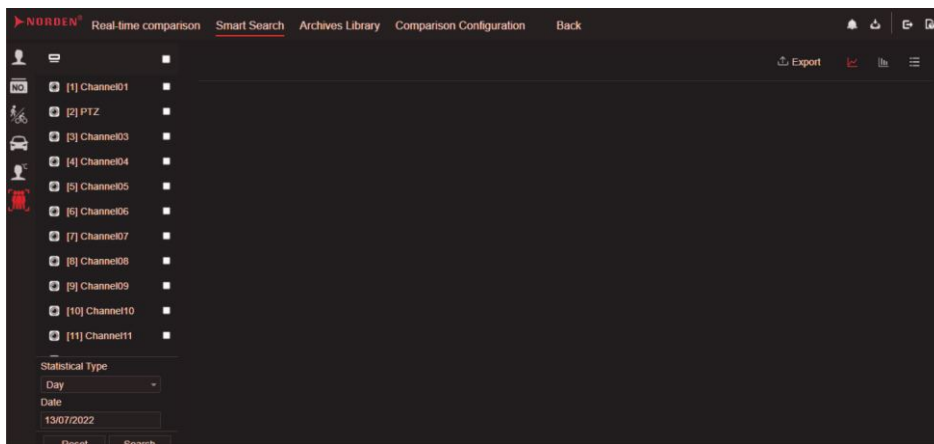


- Step 1 Choose body temperature search at smart search interface.
- Step 2 Tick the AI recognition camera channels, set the start time and end time.
- Step 3 Choose the person type, temperature type, input ID optionally.
- Step 4 Click "Search" to search the temperature.

### 8.7.2.6 Personnel Count

If the AI camera connect to NVR, the NVR can obtain the data of camera directly. Set the statistical type (day, month, year), choose the time to search. The result can be showing by line graph, histogram, or list, as shown in Figure 8-31

Figure 8-30 Personnel count

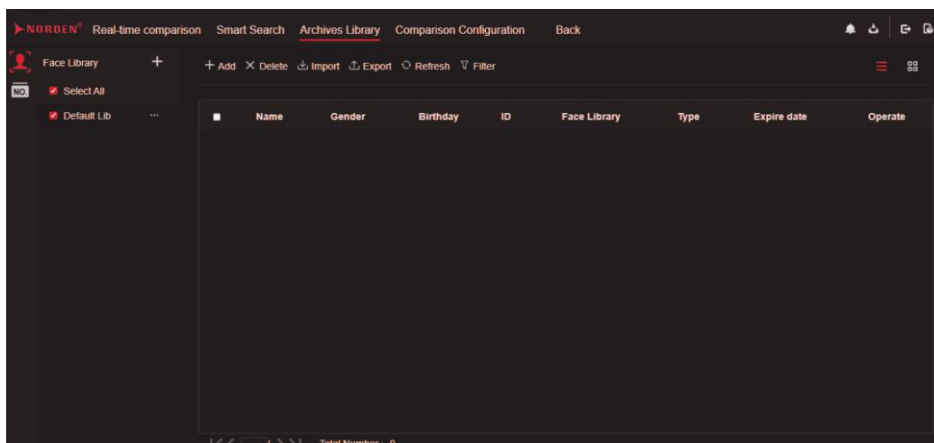


### 8.7.3 Archives Library

At archives library, user can add or edit the face library, license plate library.

#### 8.7.3.1 Face Library

Figure 8-31 Face library



Click "+" to add face library.


Click "Add" to add person enroll.

Tick the person, click "Delete" to delete the person.

Click "Import" to add the person batch.

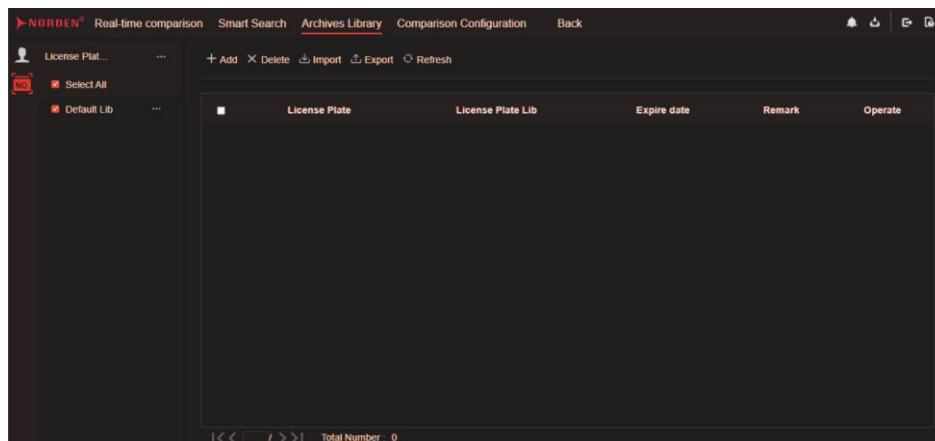
Click "Export" to export the all person in library.

Click operate icon to edit or delete the chosen person.

Snapshot in real time video, put the cursor on picture such as  , you can add it to face library, or face search. The cursor on area 6 and the pictures is not update, move the mouse so that the pictures can be shown in time.

### 8.7.3.2 License Plate Library

Figure 8-32 License plate library



Click "+" to add license plate library.

Click "Add" to add plate to library.

Tick the plate, click "Delete" to delete the license plate.

Click "Import" to add the license plate batch.

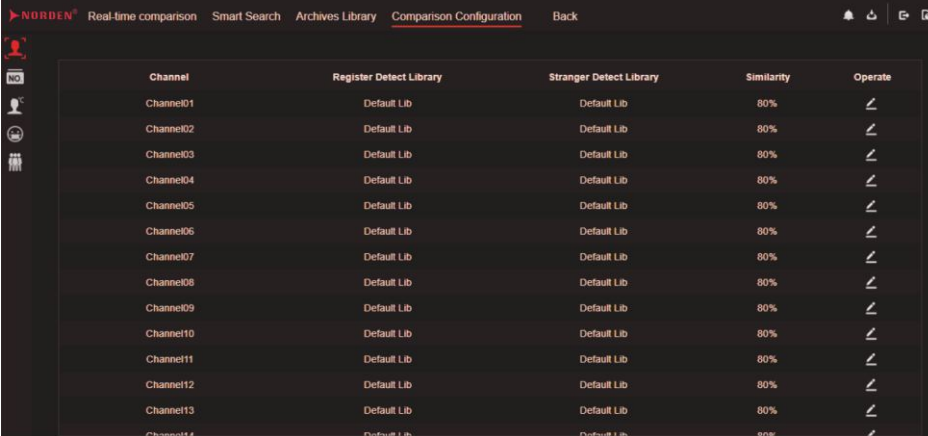
Click "Export" to export the all-license plate library.

Click operate icon to edit or delete the chosen license plate.

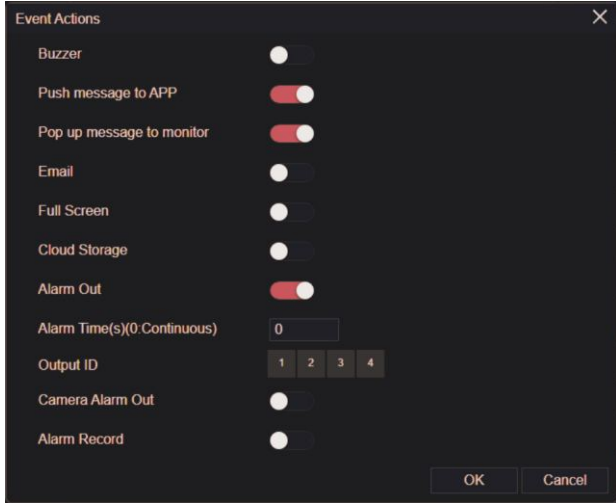
### 8.7.4 Comparison Configuration

At comparison configuration interface, user can set the comparison of human face/ license plate/temperature.

Figure 8-33 Face comparison



| Channel   | Register Detect Library | Stranger Detect Library | Similarity | Operate |
|-----------|-------------------------|-------------------------|------------|---------|
| Channel01 | Default Lib             | Default Lib             | 80%        | ↙       |
| Channel02 | Default Lib             | Default Lib             | 80%        | ↙       |
| Channel03 | Default Lib             | Default Lib             | 80%        | ↙       |
| Channel04 | Default Lib             | Default Lib             | 80%        | ↙       |
| Channel05 | Default Lib             | Default Lib             | 80%        | ↙       |
| Channel06 | Default Lib             | Default Lib             | 80%        | ↙       |
| Channel07 | Default Lib             | Default Lib             | 80%        | ↙       |
| Channel08 | Default Lib             | Default Lib             | 80%        | ↙       |
| Channel09 | Default Lib             | Default Lib             | 80%        | ↙       |
| Channel10 | Default Lib             | Default Lib             | 80%        | ↙       |
| Channel11 | Default Lib             | Default Lib             | 80%        | ↙       |
| Channel12 | Default Lib             | Default Lib             | 80%        | ↙       |
| Channel13 | Default Lib             | Default Lib             | 80%        | ↙       |



Event Actions

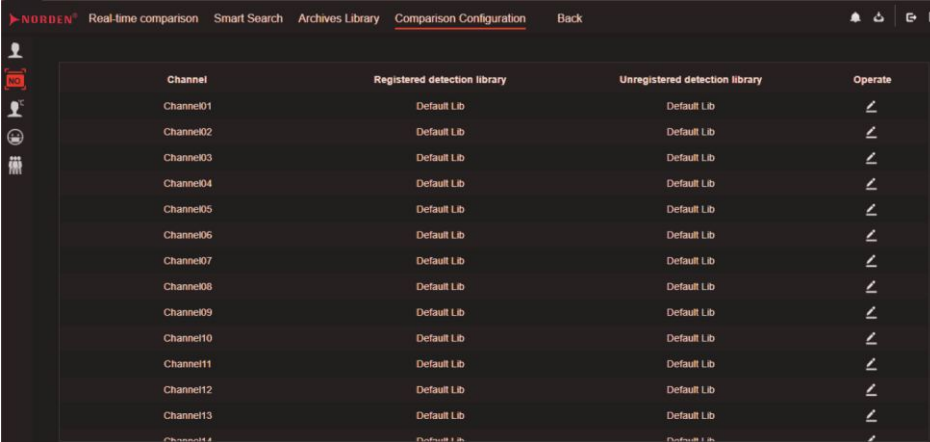
- Buzzer
- Push message to APP
- Pop up message to monitor
- Email
- Full Screen
- Cloud Storage
- Alarm Out
- Alarm Time(s)(0:Continuous)
- Output ID
- Camera Alarm Out
- Alarm Record

OK Cancel

At face comparison interface, user can set different channels' strategy, such as similarity, display comparison result, face library, enable alarming, event action, arming time, as shown in Figure 8-33



Figure 8-35 License comparison

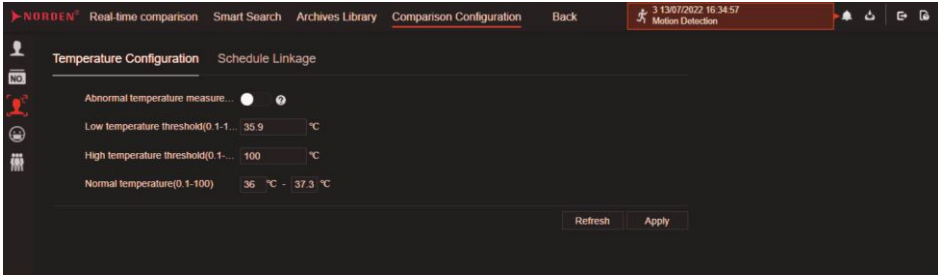


| Channel   | Registered detection library | Unregistered detection library | Operate |
|-----------|------------------------------|--------------------------------|---------|
| Channel01 | Default Lib                  | Default Lib                    | ✓       |
| Channel02 | Default Lib                  | Default Lib                    | ✓       |
| Channel03 | Default Lib                  | Default Lib                    | ✓       |
| Channel04 | Default Lib                  | Default Lib                    | ✓       |
| Channel05 | Default Lib                  | Default Lib                    | ✓       |
| Channel06 | Default Lib                  | Default Lib                    | ✓       |
| Channel07 | Default Lib                  | Default Lib                    | ✓       |
| Channel08 | Default Lib                  | Default Lib                    | ✓       |
| Channel09 | Default Lib                  | Default Lib                    | ✓       |
| Channel10 | Default Lib                  | Default Lib                    | ✓       |
| Channel11 | Default Lib                  | Default Lib                    | ✓       |
| Channel12 | Default Lib                  | Default Lib                    | ✓       |
| Channel13 | Default Lib                  | Default Lib                    | ✓       |

At face comparison interface, user can set different channels' strategy, such as similarity, display comparison result, face library, enable alarming, event action, arming time, as shown in Figure 8-33

 means the library is deleted.

Figure 8-36 Temperature comparison



Temperature Configuration

Abnormal temperature measure...

Low temperature threshold(0.1-100) 35.9 °C

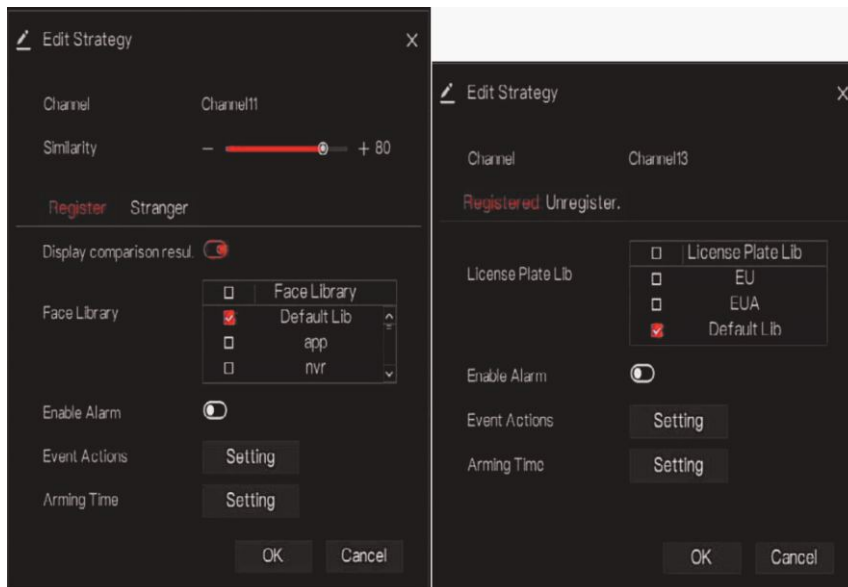
High temperature threshold(0.1-100) 100 °C

Normal temperature(0.1-100) 36 °C - 37.3 °C

Refresh Apply

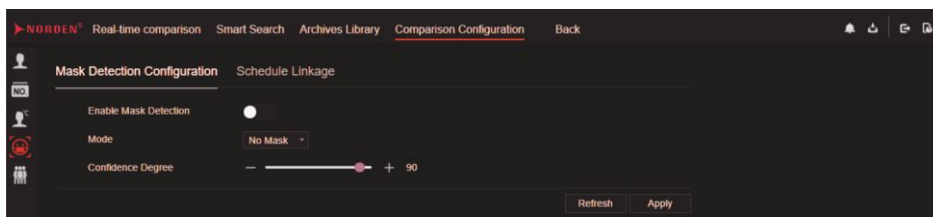
At temperature comparison interface, user can set low temperature threshold, high temperature threshold, normal temperature, as shown in Figure 8-36

Figure 8-37 Strategy



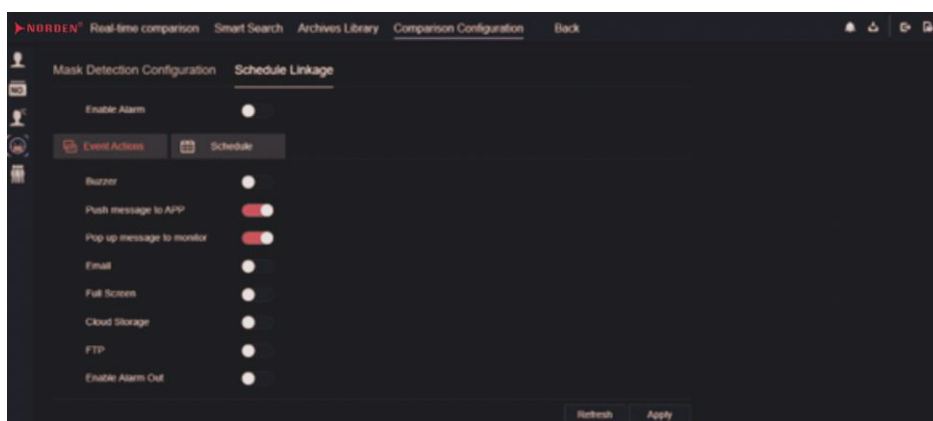
Mask detection configuration: enable mask detection, set the mode (wear mask, no mask). Set confidence degree, the default value is 90. Click "apply" to save the settings.

Figure 8-38 Mask detection configuration



Enable mask alarm linkage, set the event action and schedule.

Figure 8-39 Schedule linkage



The alarm information is relevant to mask detection configuration.

## 9. System Setting

The system setting allows you to set system, channel, record, alarm, network and local setting.

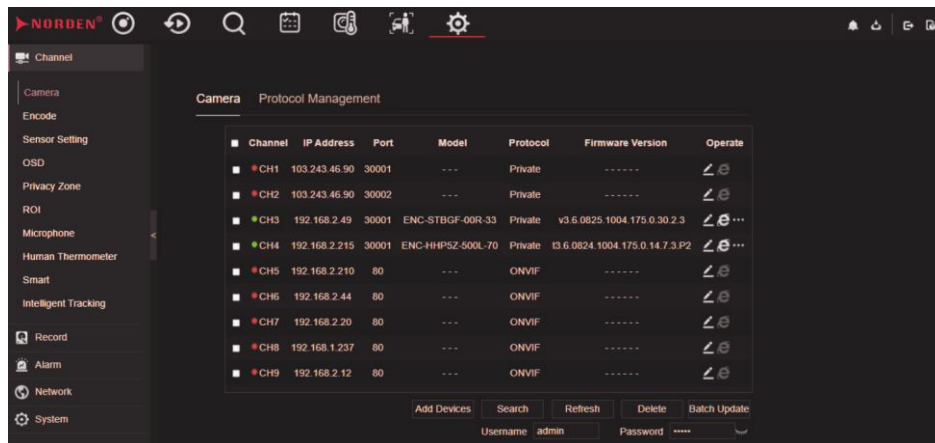
### 9.1 Channel

User can set parameter about camera, encode, sensor setting, OSD and privacy zone.

#### 9.1.1 Camera

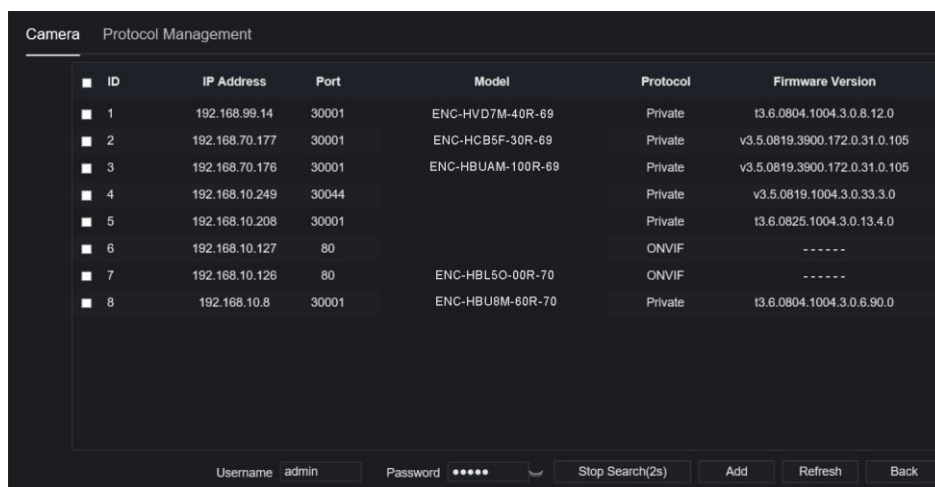
Step 0 On the **System Setting** screen, choose **Channel > Camera** to access the camera interface, as shown in Figure 9-1

Figure 9-1 Camera interface



- Step 1 Input username and password (the default value both are admin), and click **Click To Add** add cameras automatically.
- Step 2 Click **Search** to search cameras at the same LAN as NVR, as shown in . Choose the camera, input username and password, click **Add** to add new camera.

Figure 9-2 Device search




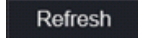
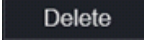


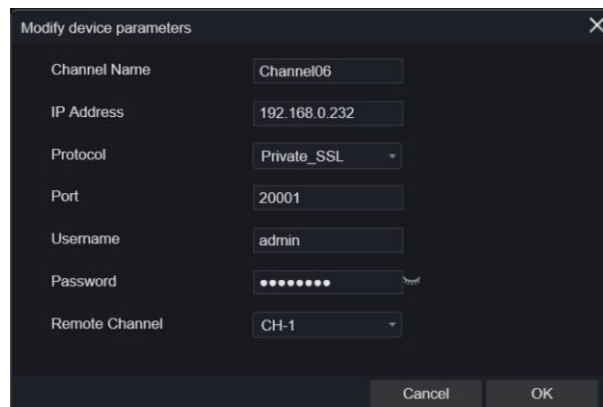
- Step 3 Click  to back to camera interface.
- Step 4 Click  to refresh cameras status.
- Step 5 Choose the cameras and click  to delete.
- Step 6 Click  to update all selected cameras at once, the pop-up window would show to select software.
- Step 7 Click  to modify the information of device parameters, as shown in Figure 9-3

Figure 9-3 Modify device parameters



The dialog box 'Modify device parameters' contains the following fields:

- Channel Name: Channel06
- IP Address: 192.168.0.232
- Protocol: Private\_SSL
- Port: 20001
- Username: admin
- Password: [masked]
- Remote Channel: CH-1

Buttons: Cancel, OK


- Step 8 Click  to add camera manually, click the added channel to copy information to add, so that user just modify some information quickly, as shown in Figure 9-4

Figure 9-4 Modify device parameters




The dialog box 'Manually Add Devices' contains a table of existing channels and a form for adding a new one.

| Channel | IP                   | Protocol |
|---------|----------------------|----------|
| CH1     | 192.168.32.196:30001 | Private  |
| CH2     | 192.168.32.222:30001 | Private  |
| CH3     | 192.168.32.5:30001   | Private  |
| CH4     | 192.168.32.175:30001 | Private  |

Form fields below the table:

- Channel: 32
- IP Address: 192.168.32.5
- Protocol: Private
- Port: 30001
- Username: admin
- Password: [masked]
- Remote Channel: CH-1

Buttons: OK, Cancel

- Step 8 Click  to access web immediately.



Step 10 Click  to update, reboot or reset the selected camera, as  shows. The pop-up message "Are you sure to restart the device?" "Are you sure to reset? Reserve IP Address" would respectively show.

Figure 9-5 Modify IP



 **NOTE**



: it indicates the camera is online, user can view the live video immediately.

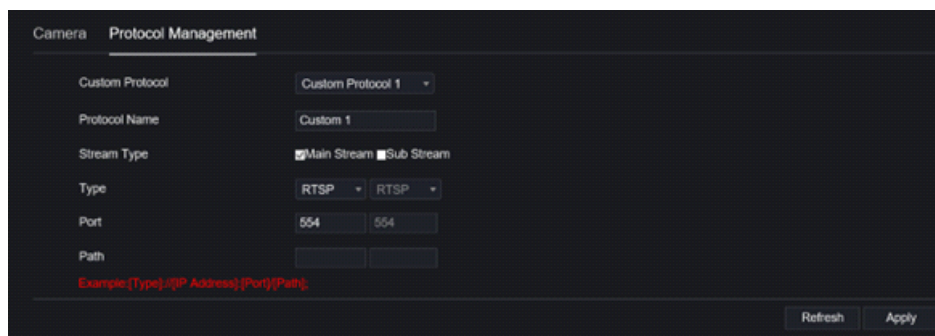



: it indicates the camera is offline, it maybe not connect the network, or the password is incorrect. User access to the modify device parameters interface to change.

### 9.1.1.1 Protocol Management

Set the protocol management, user can add different protocol cameras to NVR

Figure 9-6 Protocol management

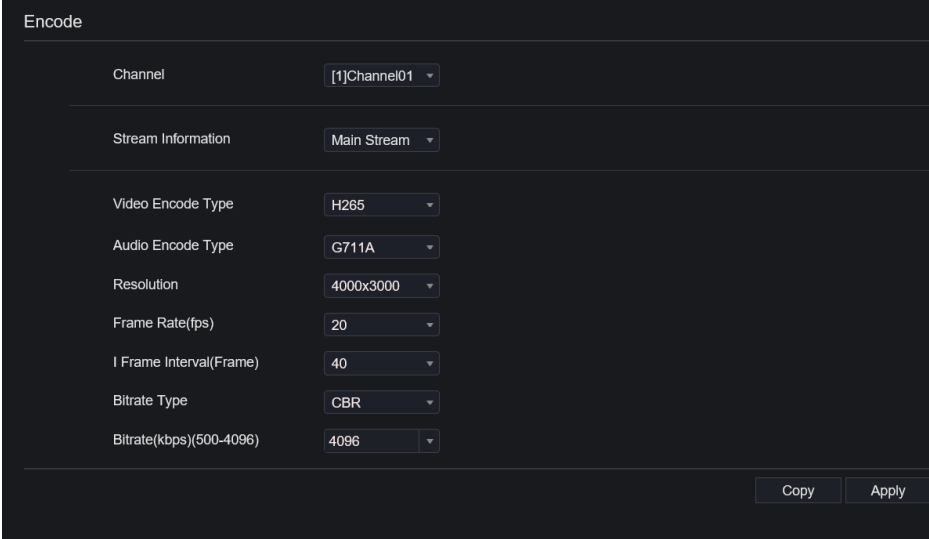


- Step 1 Click **Channel > Camera > RTSP Connection.**
- Step 2 Choose the custom protocol from the drop-down list, there are 16 kinds of protocols can be set.
- Step 3 Input the protocol name.
- Step 4 Tick main stream and sub stream. The main stream shows image on full screen live video. The sub stream shows image on split screen. If you just tick main stream and the channel will not show image on split screen.
- Step 5 Choose the type of protocol, the default value is RTSP.
- Step 6 Input the port, it depends the IP camera.
- Step 6 Input the path, it depends the manufacturer of cameras.
- Step 8 Click  to save the settings.

## 9.1.2 Encode

Step 1 On the **System Setting** screen, choose **Channel > Encode** to access the encode interface, as shown in Figure 9-7

Figure 9-7 Encode interface



The screenshot shows the 'Encode' interface with the following settings:

| Setting                 | Value        |
|-------------------------|--------------|
| Channel                 | [1]Channel01 |
| Stream Information      | Main Stream  |
| Video Encode Type       | H265         |
| Audio Encode Type       | G711A        |
| Resolution              | 4000x3000    |
| Frame Rate(fps)         | 20           |
| I Frame Interval(Frame) | 40           |
| Bitrate Type            | CBR          |
| Bitrate(kbps)(500-4096) | 4096         |

Buttons: Copy, Apply

Step 2 Select a channel from drop-down list.

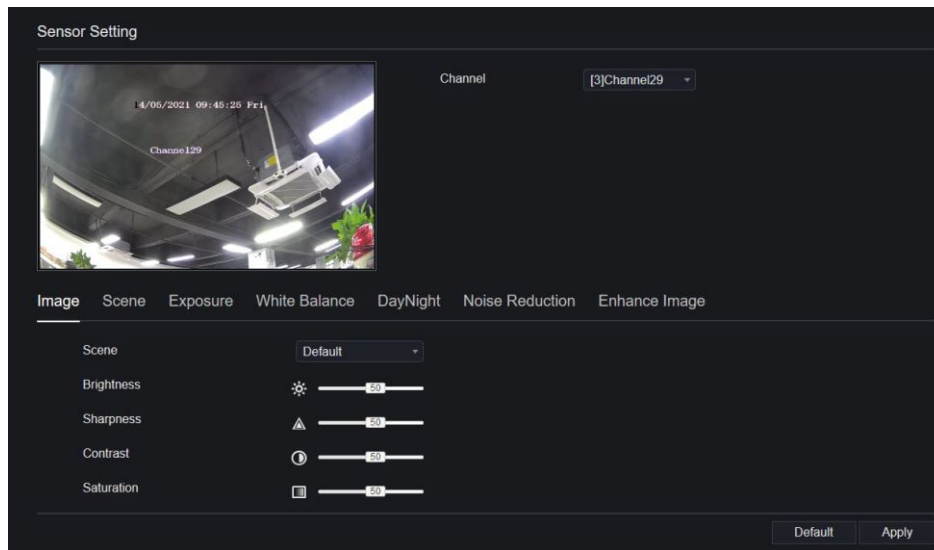
Step 3 Select stream information, encode type, resolution, frame rate, bitrate control and bitrate from drop-down list.

Step 4 Click **Copy** to choose other camera to copy settings. Click **Apply** to save the settings.

## 9.1.3 Sensor Setting

Step 1 On the **System Setting** screen, choose **Channel > Sensor Setting** to access the sensor setting interface, as shown in Figure 9-8

Figure 9-8 Image interface



- Step 1 Select a channel and scene from drop-down list.
- Step 2 Set image parameters, like scene, brightness, sharpness, contrast and saturation.
- Step 3 Other parameters are camera's sensor setting, user can refer IP cameras' settings.
- Step 5 Click **Copy** to choose other camera to copy settings. Click **Apply** to save the settings.

#### NOTE

**Brightness:** It indicates the total brightness of an image. As the value increases, the image becomes brighter.

**Sharpness:** It indicates the border sharpness of an image. As the value increases, the borders become clearer, and the number of noise points increases.

**Saturation:** It indicates the color saturation of an image. As the value increases, the image becomes more colorful.

**Contrast:** It indicates the measurement of different brightness levels between the brightest white and darkest black in an image. The larger the difference range is, the greater the contrast; the smaller the difference range is, the smaller the contrast.

**Scene:** it includes indoor, outdoor, default. Mirror includes normal, horizontal, vertical, horizontal + vertical.

**Exposure:** it includes mode, max shutter, meter area and max gain.

**White balance:** it includes tungsten, fluorescent, daylight, shadow, manual, etc.

**Day-night:** user can transit day to night, or switch mode.

**Noise reduction:** it includes 2D NR and 3D NR.

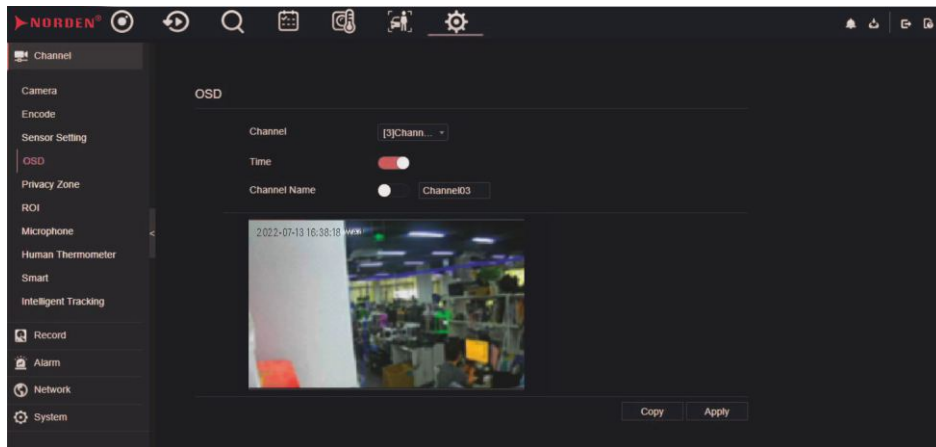
**Enhance image:** it includes WDR, HLC, BLC, defog and anti-shake.

**Zoom focus:** user can zoom and focus.

### 9.1.4 OSD

- Step 1 On the **System Setting** screen, choose **Channel > OSD** to access the OSD interface, as shown in Figure 5-4

Figure 9-9 OSD interface

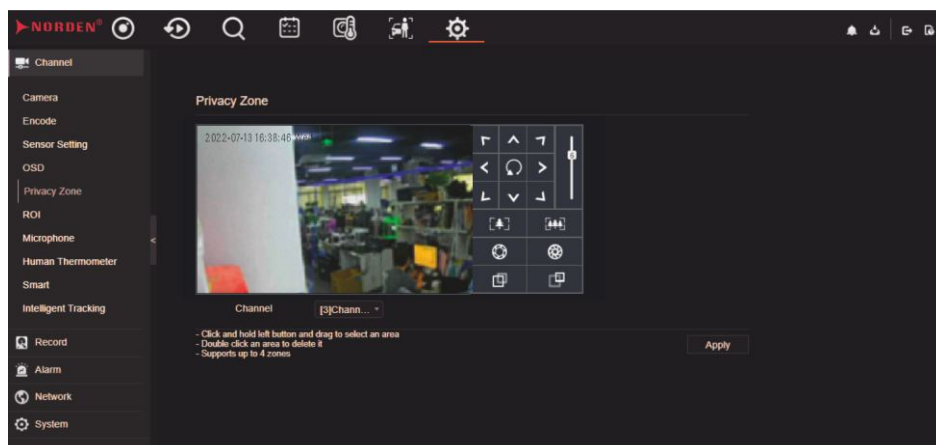


- Step 1 Select a channel and scene from drop down list.
- Step 2 Enable time and channel name. You can set channel name. Drag the icon of Channel Name or Date and Time to move, select the location.
- Step 2 Click **Copy** to choose other camera to copy settings. Click **Apply** to save the settings.

### 9.1.5 Privacy Zone

- Step 1 On the **System Setting** screen, choose **Channel > Privacy Zone** to access the privacy zone interface, as shown in Figure 9-10

Figure 9-10 Privacy interface



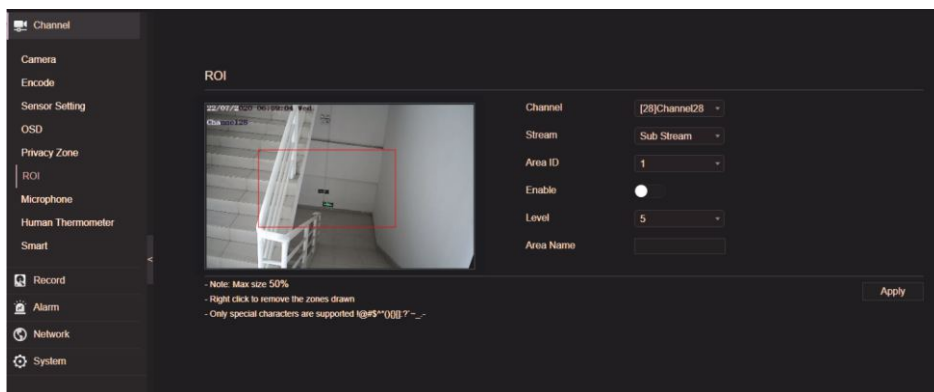


- Step 1 Select a channel from drop-down list.
- Step 2 Drag the mouse to select area to cover with rectangle frame. You can set less than four areas to be covered. Double click would delete the area.
- Step 3 PTZ can be used for adjusting the IP dome cameras.
- Step 4 Click **Copy** to choose other camera to copy settings. Click **Apply** to save the settings.

### 9.1.6 ROI

ROI(Region of interest), choose channel, stream, area ID and draw the area. Set the level, there are five levels can be chosen. Set area name, click "Apply" to save the settings.

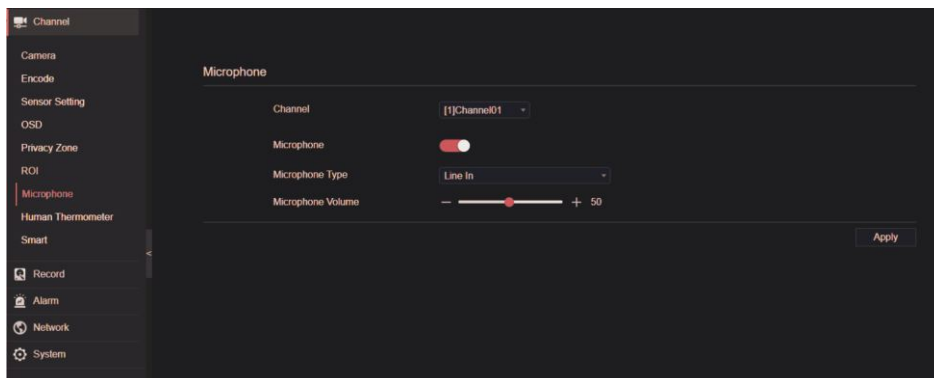
Figure 9-11 ROI



### 9.1.7 Microphone (Only for Some Models)

User can set the microphone parameters of channel.

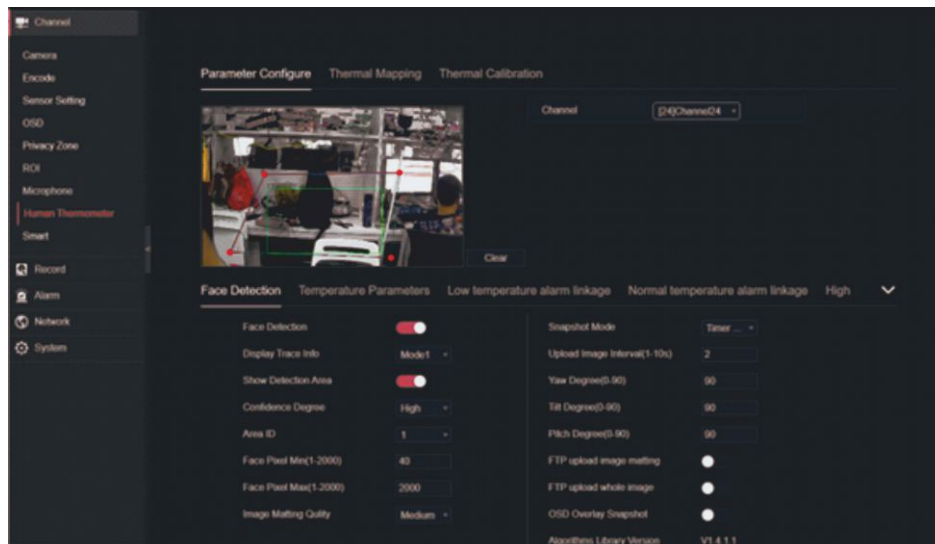
Figure 9-12 Microphone



### 9.1.8 Human Thermometer (Only for some Models)

User can set the parameters of human thermometer cameras, such as parameter configure, thermal mapping, thermal calibration, the detail please refer to the UI settings.

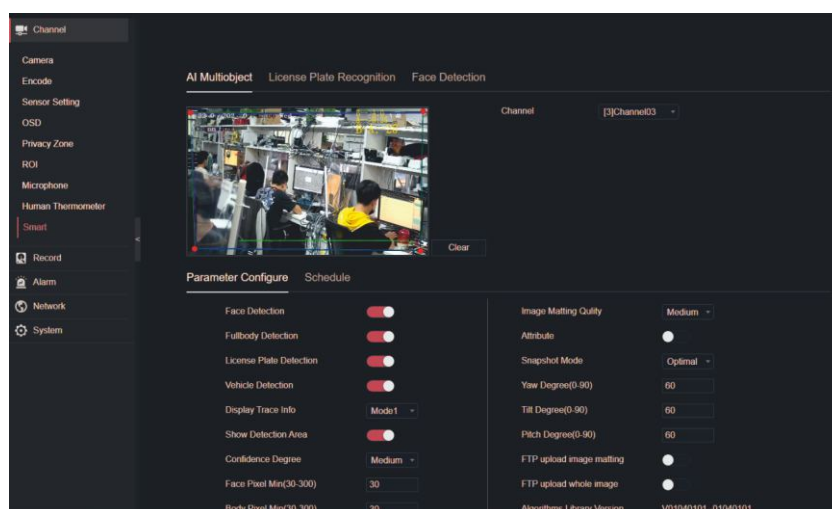
Figure 9-13 Human thermometer



### 9.1.9 Smart (Only for Some Models)

At smart interface, user can set AI multiobject, license plate recognition, face detection.

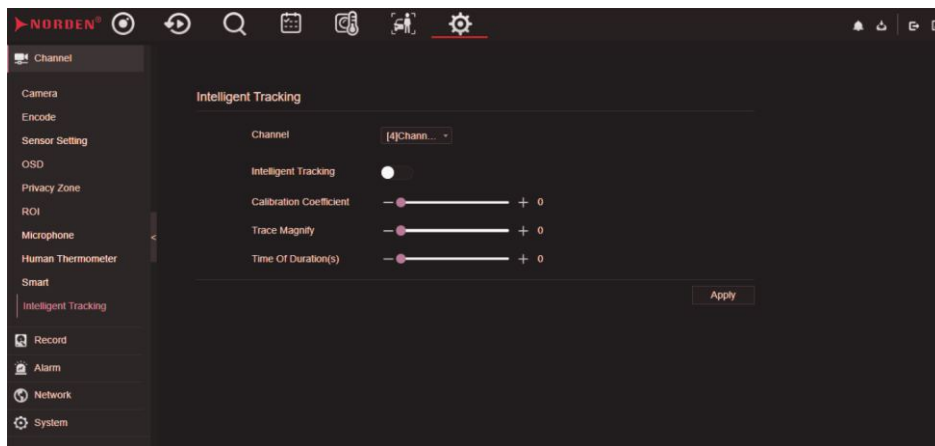
Figure 9-1-9 Smart



### 9.1.10 Intelligent Tracking (Only for Some Models)

This function only can be used for high speed dome camera. It works with PTZ function.

Figure 9-15 Intelligent tracking



The detail information please refer to UI configuration setting.

## 9.2 Record

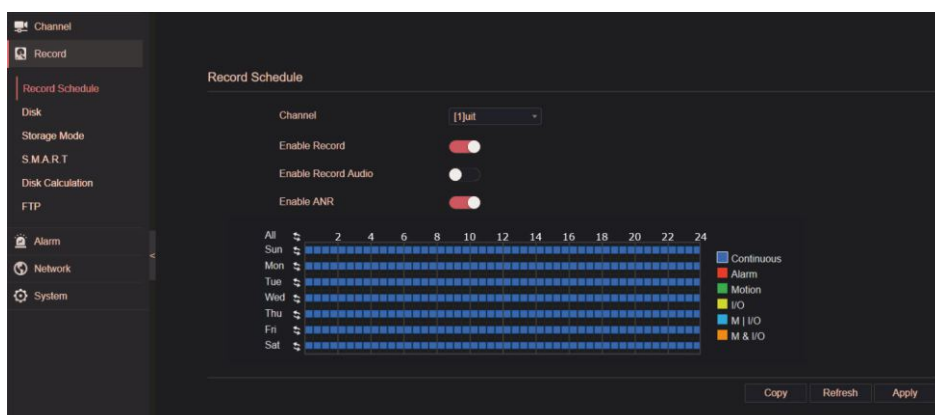
Users can set record policy in storage interface.


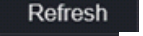
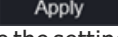
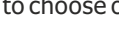
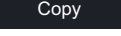

### 9.2.1 Record Schedule

Procedure

Step 1 On the **System Setting** screen, choose **Record > Record schedule** to access the record schedule interface, as shown in Figure 9-16

Figure 9-16 Record schedule interface

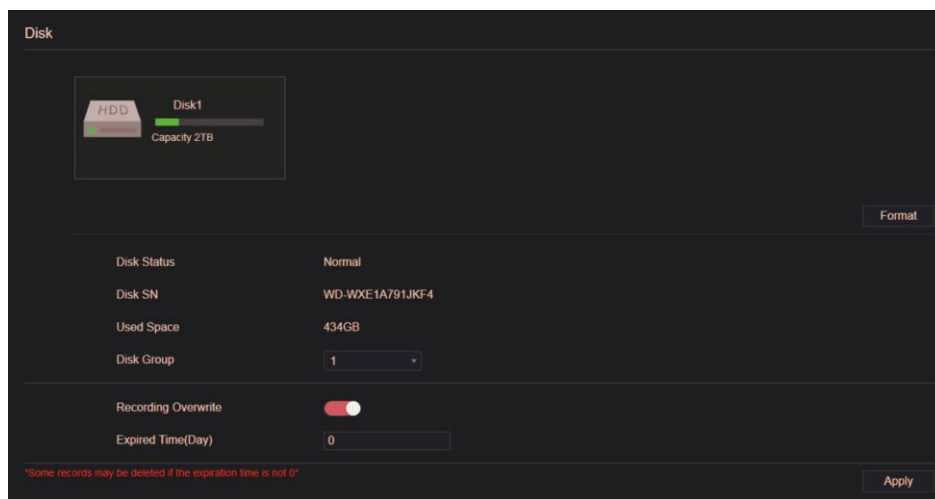



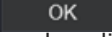

- Step 1 Select a channel .
- Step 2 Enable the record, then enable record audio.
- Step 3 Enable ANR, when the IP cameras support the ANR, if the cameras are disconnected to NVR, the NVR can copy the loss video recording from SD card installed in cameras.
- Step 4 Set the record schedule, you can drag the mouse to choose area, click  to choose all day or all week, you can also click one by one to set the schedule. Or dray the mouse cursor to choose. User can set the alarm recording to save the space of disk.
- Step 5 Click  to return the previous settings.
- Step 6 Click  to choose other camera to copy settings. Click  to save the settings.
- step 7 Click "copy"  to choose other cameras to copy settings. Click "Apply"  to save the settings.

## 9.2.2 Disk

- Step 1 On the **System Setting** screen, choose **Record > Disk** to access the disk interface, as shown in Figure 9-17

Figure 9-17 Disk interface

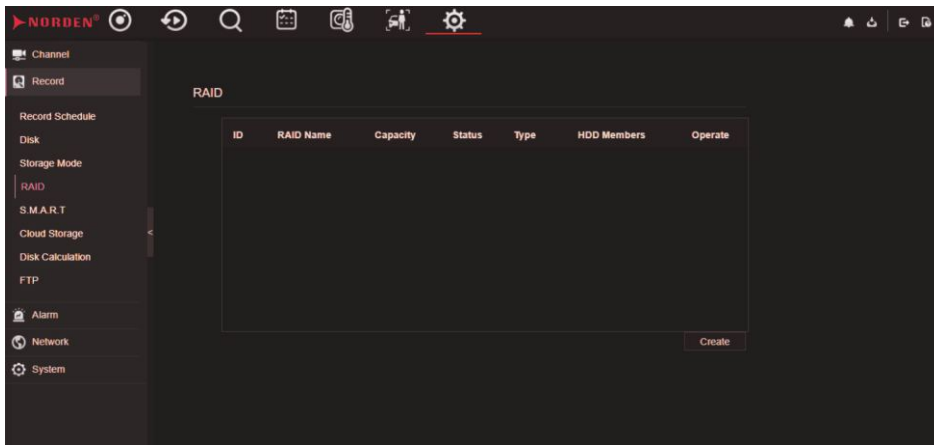


- Step 2 You can view the information like capacity, disk status, disk SN code and used space.
- Step 3 Click  to delete all data. Before deleting data user will view pop-up window "Are you sure to format disk? Your data will be lost". Click  to delete, click  to quit.
- Step 4 Choose the disk group from drop-down list, there are four disk group.
- Step 5 Enable the recording overwrite, set the expired time. (If the expired time is 0, it means the disk is full, then the recording will be rewrite. It the expired time is 5 days, the recording video will be rewrite when is to five days.)
- Step 6 If the recording overwrite is disable, user need to set the expired time, it is up to 90 days.

### 9.2.3 RAID (Only for Some Models)

 **NOTE**

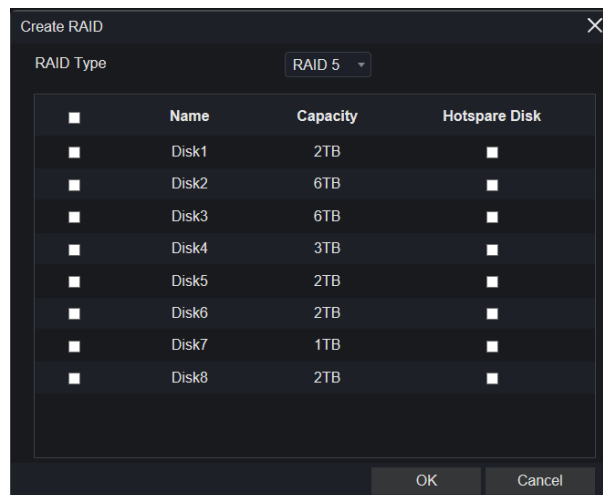
RAID is only used for the device with 4 disks or more. And the disks must be enterprise level disks. The capacity of disks are better same for efficient using.  
 RAID5 at least 3 disks can be created. RAID6 at least 4 disks can be created. RAID10 at least 4 disks can be created. Create hot spare disk need more one disk or double basic disks.  
 The capacity of disks are better same for efficient using.



#### Operation Steps

Step 1 Click **RAID** to create the RAID.

Figure 9-18 Create RAID



Step 2 Click **Create** to choose disk to create a new RAID.

Step 3 Tick the **Hot-spare** Disk to back up the broken disk in case, the number of disk must more than basic disks.

Step 4 Click **OK** to save the creation, format the new RAID



Step 5 click **format it will show**

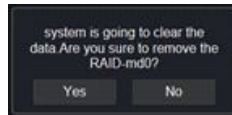


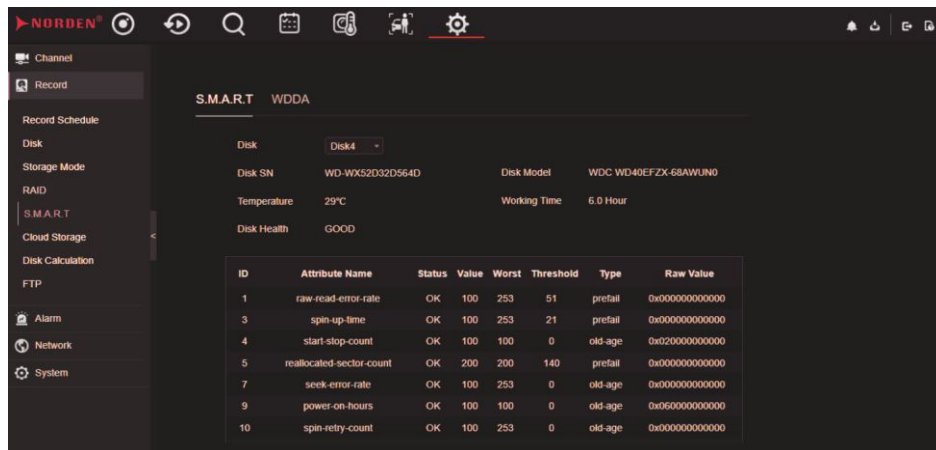
Figure 9-19 Modify the RAID

| RAID.md0  |          |          |               |        |               |         |
|-----------|----------|----------|---------------|--------|---------------|---------|
| RAID Name | RAID.md0 | Type     | RAID 5        |        |               |         |
| Capacity  | 6TB      | Members  | Disk1,2,3,4,5 |        |               |         |
| ID        | Name     | Capacity | Status        | Type   | Hotspare Disk | Operate |
| 1         | Disk1    | 2TB      | Active        | RAID 5 | No            |         |
| 2         | Disk2    | 6TB      | Active        | RAID 5 | No            |         |
| 3         | Disk3    | 6TB      | Active        | RAID 5 | No            |         |
| 4         | Disk4    | 3TB      | Active        | RAID 5 | No            |         |
| 5         | Disk5    | 2TB      | Spare         | RAID 5 | Yes           |         |
| 6         | Disk6    | 2TB      | --            | HDD    | --            | +       |
| 7         | Disk7    | 1TB      | --            | HDD    | --            | +       |
| 8         | Disk8    | 2TB      | --            | HDD    | --            | +       |

## 9.2.4 S.M.A.R.T

S.M.A.R.T is Self-Monitoring Analysis and Reporting Technology, user can view the health of disk, as shown in Figure 9-20

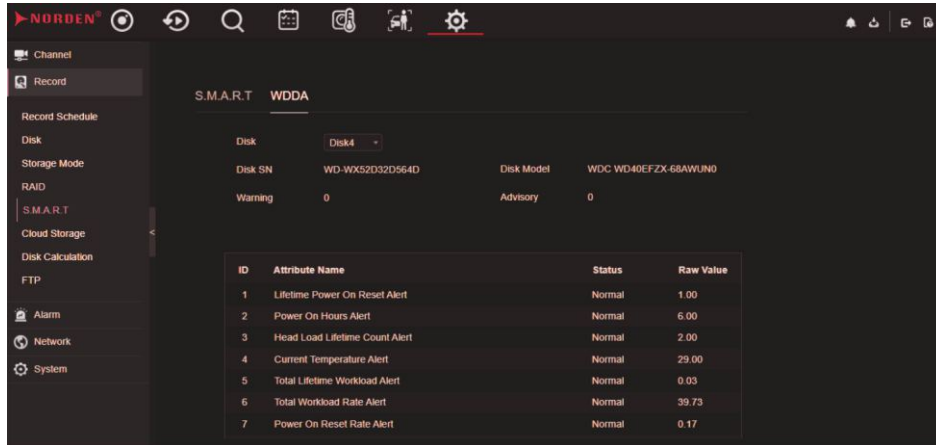
Figure 9-20 S.M.A.R.T



| ID | Attribute Name           | Status | Value | Worst | Threshold | Type    | Raw Value      |
|----|--------------------------|--------|-------|-------|-----------|---------|----------------|
| 1  | raw-read-error-rate      | OK     | 100   | 253   | 51        | prefail | 0x000000000000 |
| 3  | spin-up-time             | OK     | 100   | 253   | 21        | prefail | 0x000000000000 |
| 4  | start-stop-count         | OK     | 100   | 100   | 0         | old-age | 0x020000000000 |
| 5  | reallocated-sector-count | OK     | 200   | 200   | 140       | prefail | 0x000000000000 |
| 7  | seek-error-rate          | OK     | 100   | 253   | 0         | old-age | 0x000000000000 |
| 9  | power-on-hours           | OK     | 100   | 100   | 0         | old-age | 0x060000000000 |
| 10 | spin-retry-count         | OK     | 100   | 253   | 0         | old-age | 0x000000000000 |

The disk of Western Digital can be viewed by WDDA, as shown in Figure 9-21

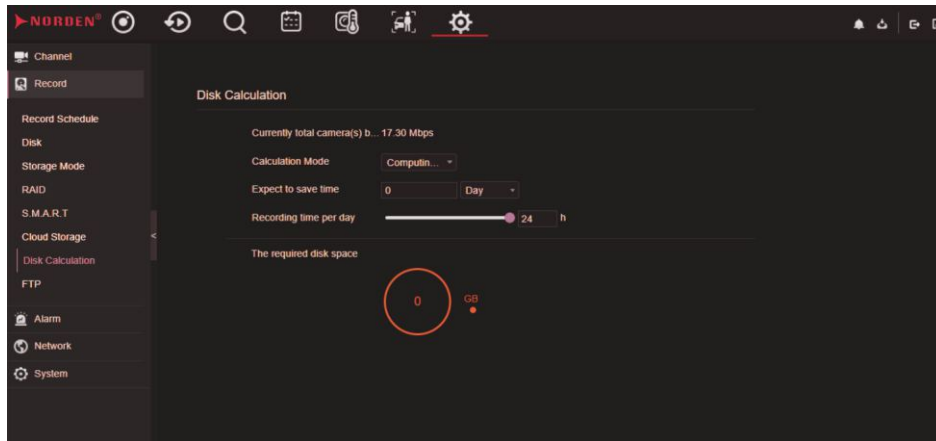
Figure 9-21 WDDA (Supplied for Some Models)



## 9.2.5 Disk Calculation

There are two modes to calculate the captivity of disk, as Computing Capacity  
Computation time shown in.

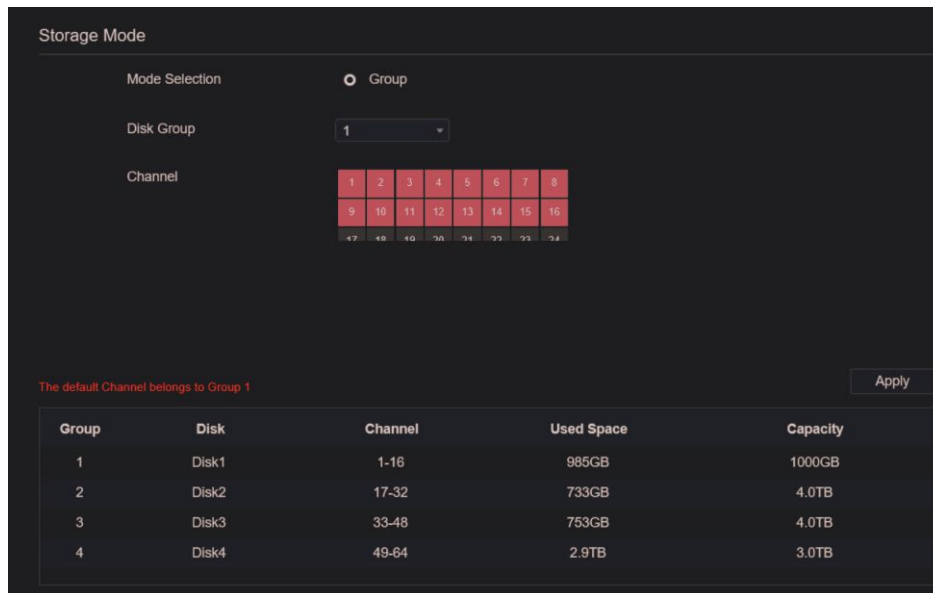
Figure 9-22 Disk calculation



## 9.2.6 Storage Mode

User is based on need to distribute the channels to different disk group, and use disk capacity reasonably.

Figure 9-23 Storage Mode



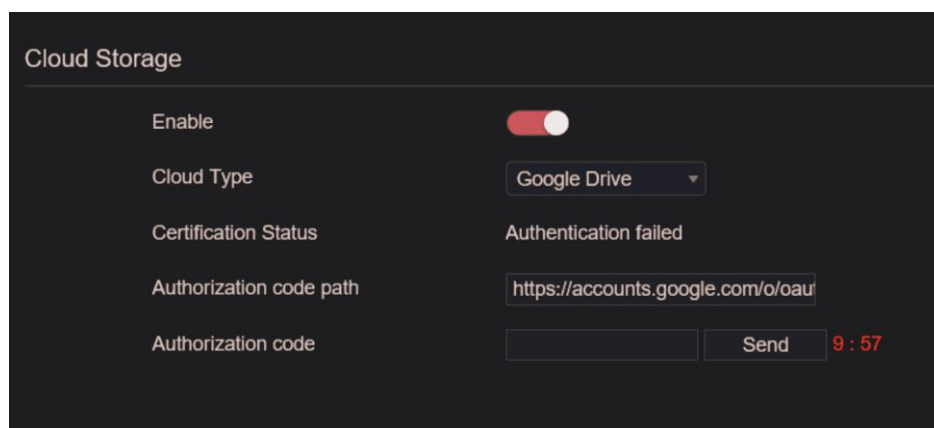
#### Operation Steps

- Step 1 Choose the disk group.
- Step 2 Select the channel to record to disk group.
- Step 3 Click Apply to save the settings.
- Step 4 The group list will show the detail information.

### 9.2.7 Cloud Storage (Only for Some Models)

User copy the authorization code path to browser to enter Google Drive interface. Google send the code, and user input the code to authority NVR, so the device can set the alarm recording to Google drive.

Figure 9-24 Cloud Storage





 **NOTE**

User should enable the alarm of cloud storage at first so that the Google drive can receive the recording. Cloud storage can only be set at motion detection and intelligent analysis interface.

## 9.3 Alarm

User can set general, motion detection, video loss, intelligent analysis and alarm in on alarm interface.

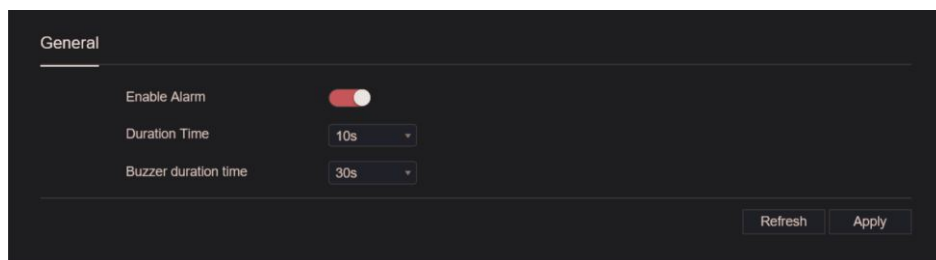
### 9.3.1.1 General

Procedure

Step 1 On the **System Setting** screen, choose **Alarm > General** to access the general interface.

Step 2 Enable alarm to set duration time and buzzer duration time, as shown in Figure 9-25

Figure 9-25 General interface



Step 3 Click  to save settings. Click  to return to the previous settings.

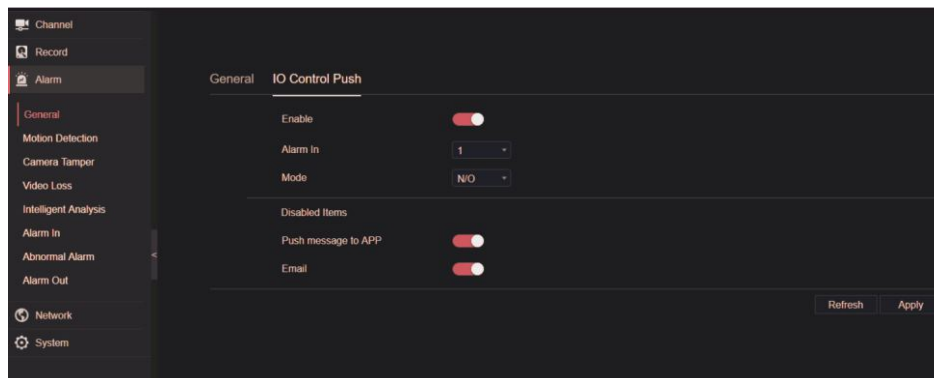
### 9.3.1.2 IO Control Push

Procedure

Step 1 On the **System Setting** screen, choose **Alarm > General > IO Control Push** to access the general interface.

Step 2 Enable the IO control push, as shown in Figure 9-26

Figure 9-26 IO control push interface



Step 3 Choose one alarm in and mode (N/C, N/O).

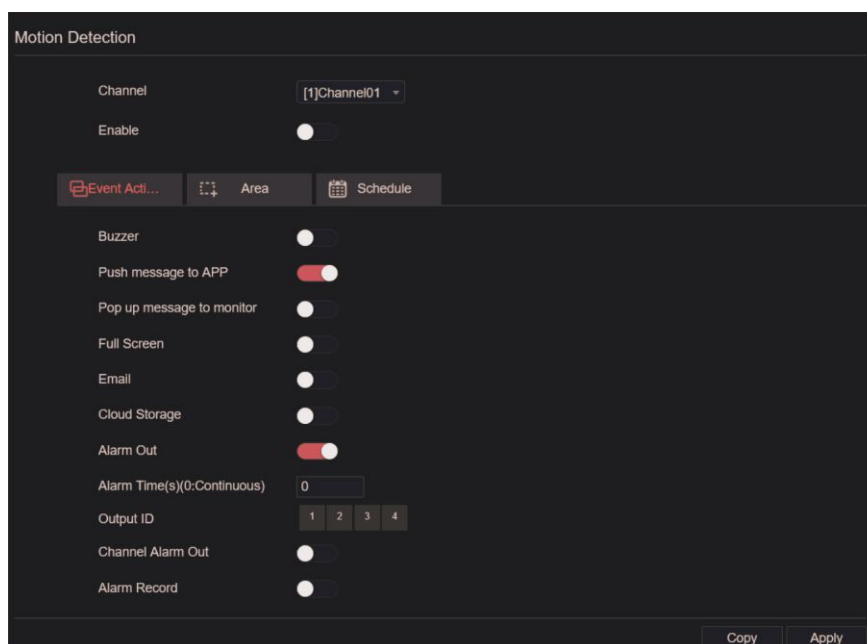
Step 4 Tick the disable items, click "Apply" to save setting.

## 9.3.2 Motion Detection

### Procedure

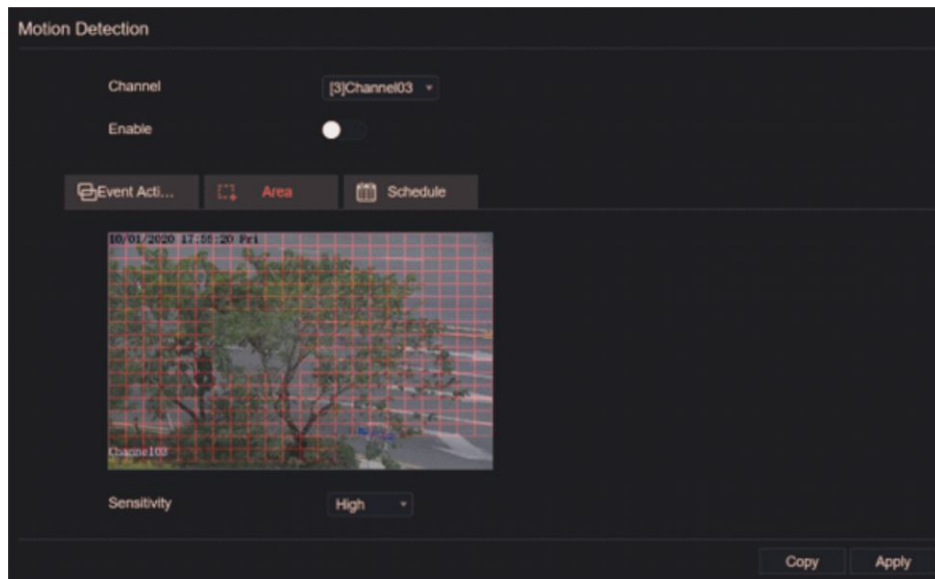
Step 1 On the **System Setting** screen, choose **Alarm > Motion Detection** to access the motion detection interface, as shown in Figure 9-27

Figure 9-27 Motion detection interface



- Step 2 Click channel drop-down list to choose channel.
- Step 3 Enable motion detection alarm.
- Step 4 Set Event Activity, includes buzzer, push message to APP, pop-up message to monitor, full screen, Email, cloud storage, alarm out (the back panel), channel alarm out (the port of cameras), and alarm record.
- Step 5 Click Area to access the motion detection area setting, as shown in .

Figure 9-28 Motion detection area interface



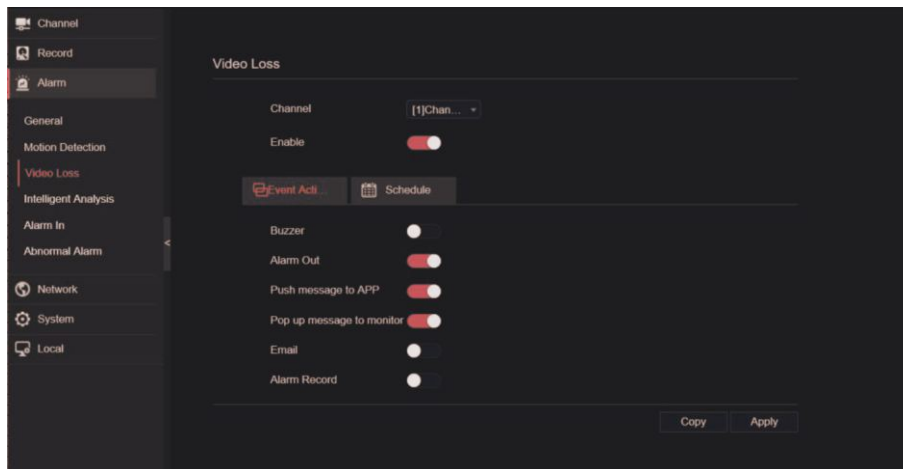
- 1. Hold down and drag the left mouse button to draw a motion detection area.
- 2. Select a value from the drop-down list next to Sensitivity.
- 3. Double-click the chosen area to delete.
- Step 6 Click Schedule to access schedule settings, drag and release mouse to select the alarming time within 00:00-24:00 from Monday to Sunday. Click the chosen area can cancel. The settings of alarm schedule are same as disk schedule.
- Step 7 Click **Copy** to choose other camera to copy settings. Click **Apply** to save the settings.

### 9.3.3 Video Loss

#### Procedure

- Step 1 On the **System Setting** screen, choose **Alarm > Video Loss** to access the video loss interface, as shown in Figure 9-29

Figure 9-29 Video loss interface



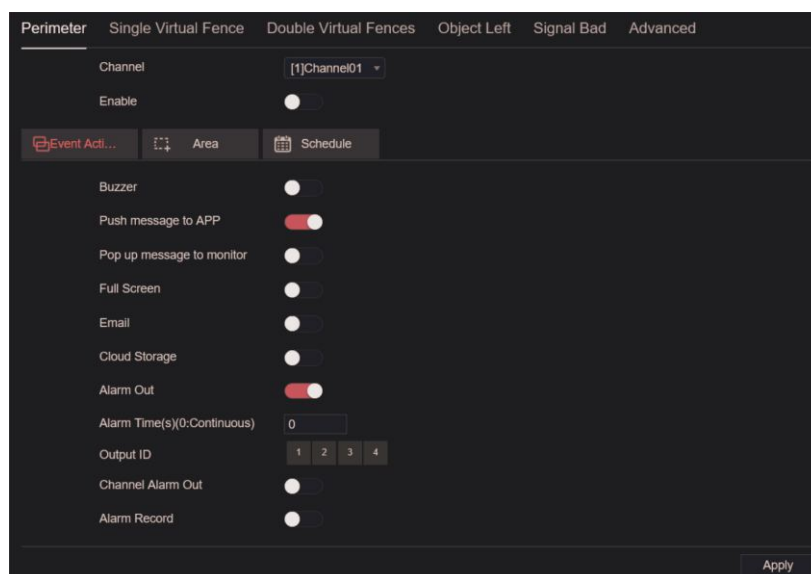
- Step 2 Click drop-down list to choose channel.
- Step 3 Enable the video loss alarm.
- Step 4 Set event activity and schedule please refer to Figure 5-1 motion detection settings.
- Step 5 Click **Copy** to choose other camera to copy settings. Click **Apply** to save the settings.

### 9.3.4 Advanced Intelligent Analysis (Only for Some Models)

#### Procedure

Please refer to chapter 7.4.1 video loss settings, interface displayed as shown in Figure 9-30

Figure 9-30 Intelligent analysis interface

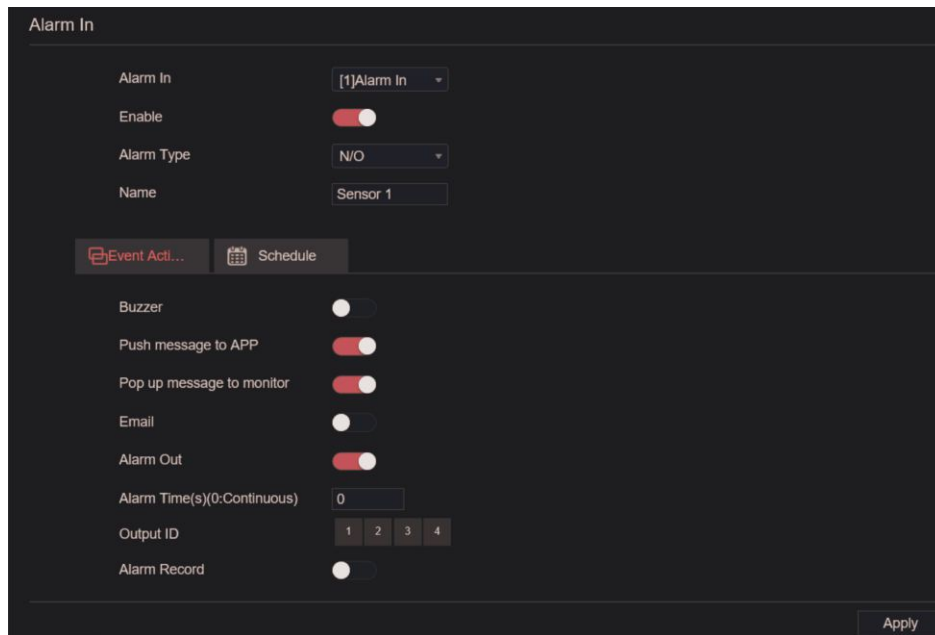


### 9.3.5 Alarm In

#### Procedure

Step 1 On the **System Setting** screen, choose **Alarm > Alarm In** to access the alarm in interface, as shown in Figure 9-31

Figure 9-31 Alarm in interface



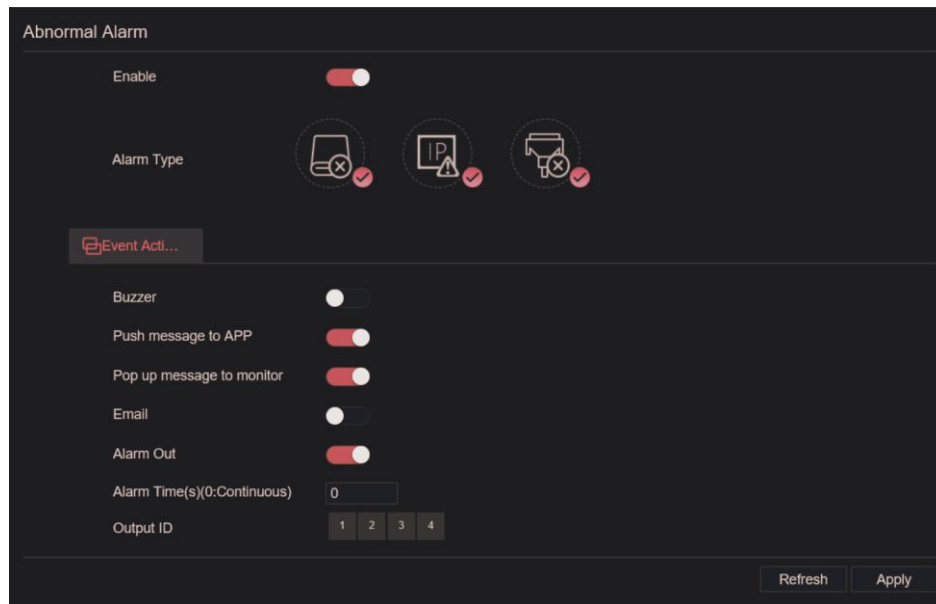
- Step 2 Click drop-down list to choose alarm in.
- Step 3 Enable the button, choose alarm type.
- Step 4 Set name, default is Sensor 1.
- Step 5 Set event activity and schedule please refer to motion detection settings.
- Step 6 Click **Apply** save settings.

### 9.3.6 Abnormal Alarm

#### Procedure

Step 1 On the **System Setting** screen, choose **Alarm > Abnormal Alarm** to access the abnormal alarm interface, as shown in Figure 9-32

Figure 9-32 Abnormal alarm interface



- Step 2 Enable the button, tick alarm type.
- Step 3 Set name, default is Sensor 1.
- Step 4 Set event activity and schedule please refer to motion detection settings.
- Step 5 Click **Apply** to save settings.

### 9.3.7 Alarm out

Set the alarm out, the camera alarm out.

Figure 9-33 Alarm out

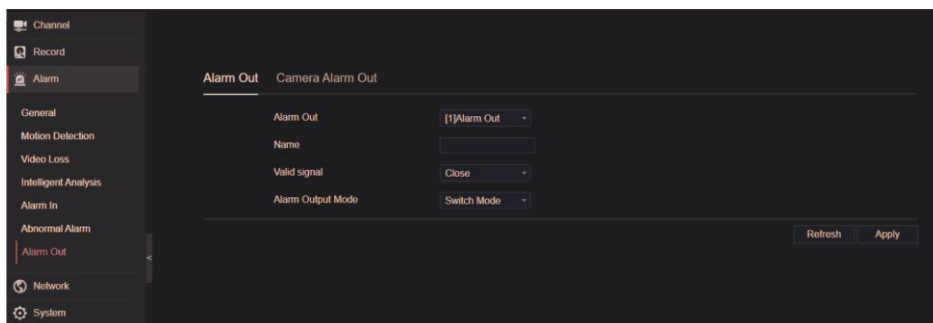
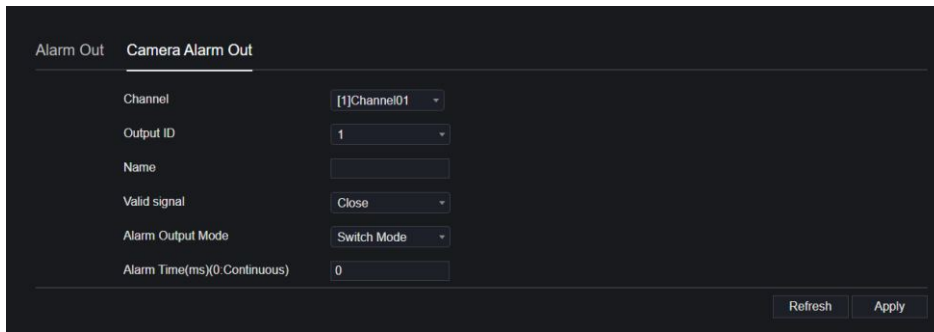


Figure 9-34 Camera alarm out



## 9.4 Network

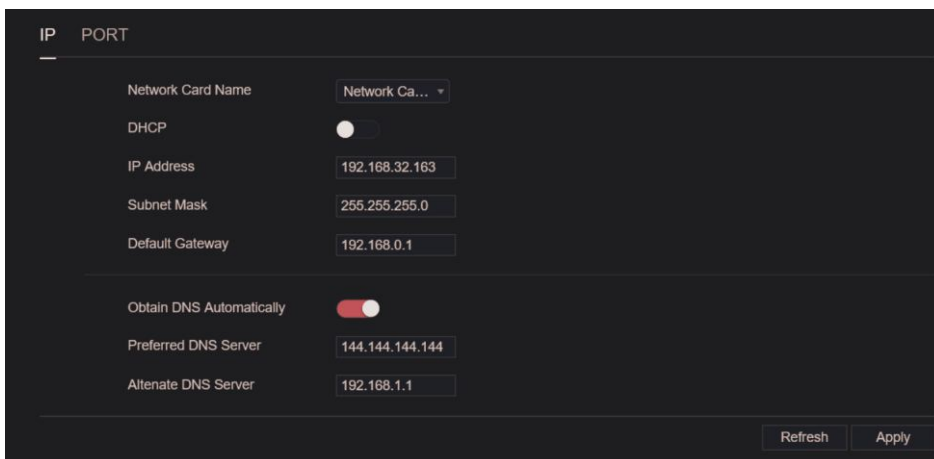
Users can set Network, DDNS, E-mail, UPnP, P2P, IP Filter, 802.1X, SNMP and Web Mode.

### 9.4.1 Network

Procedure

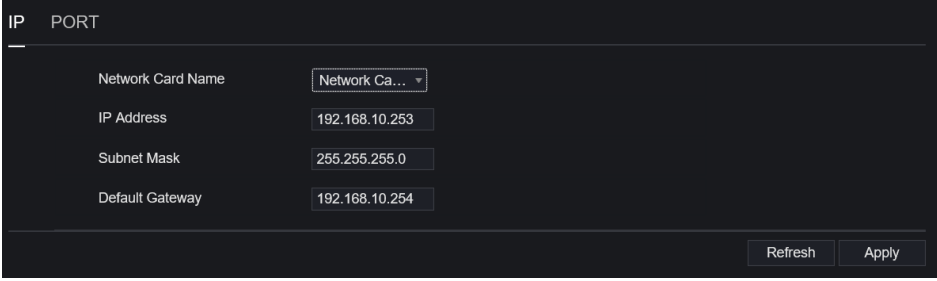
- Step 1 On the **System Setting** screen, choose **Network > Network** to access the network interface, as shown in Figure 9-35



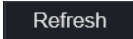
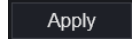
Figure 9-35 Network interface



- Step 2 Choose network card from the drop-down list. Network card I is LAN1, network card II is LAN2, as shown in Figure 9-36

Figure 9-36 Network card II

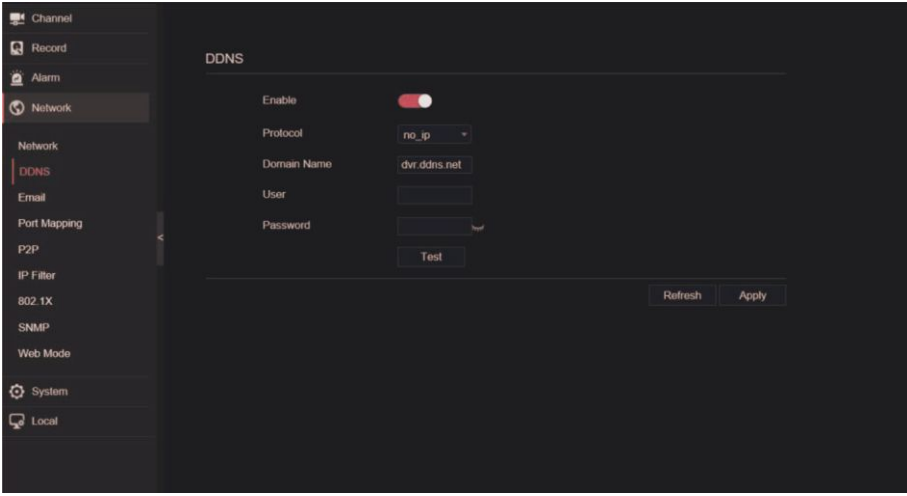


- Step 3 Click  next to IP to enable or disable the function of automatically getting an IP address. The function is enabled by default. If the function is disabled, click input boxes next to **IP, Subnet mask, and Gateway** to set the parameters as required.
- Step 4 Click  next to **Obtain DNS Automatically** to enable or disable the function of automatically getting a DNS address. The function is enabled by default.  
If the function is disabled, click input boxes next to **DNS1** and **DNS2**, delete original addresses, and enter new addresses.
- Step 5 Set **PORT** and **POE** manually, input the information about these.
- Step 6 Click  to restore previous settings. Click  to save the settings.

## 9.4.2 DDNS

- Step 1 Click **DDNS** in the network interface, choose **Network > DDNS** to access the DDNS interface as shown in Figure 9-37

Figure 9-37 DDNS interface





- Step 2 Click the button to enable the DDNS function. It is disabled by default.
- Step 3 Select a required value from the **protocol** drop-down list.
- Step 4 Set domain name, user, and password.
- Step 5 Click **Refresh** to restore previous settings. Click **Apply** to save the settings.

 **NOTE**

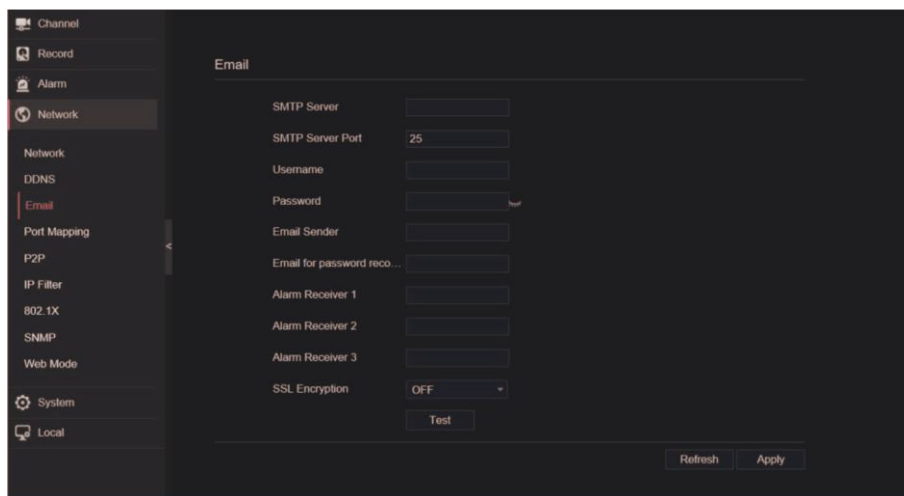
An external network can access an address specified in the DDNS settings to access the NVR.

### 9.4.3 E-mail

#### Procedure

- Step 1 Click **E-mail** in the network interface, choose **Network > E-mail** to access the E-mail interface, as shown in Figure 9-38

Figure 9-38 E-mail interface



- Step 2 Set SMTP server and SMTP server port manually.
- Step 3 Set sender E-mail, user name and password manually.
- Step 4 Set E-mail for receive alarm the message.
- Step 5 Set E-mail for retrieve the password the message.
- Step 6 Click SSL Encryption drop-down list to enable safeguard of email.
- Step 7 Click **Refresh** to restore previous settings. Click **Apply** to save the settings.

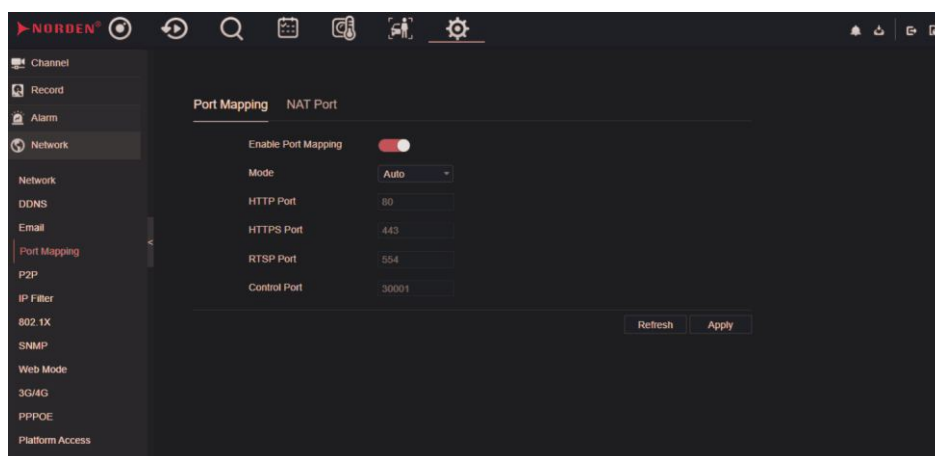
## 9.4.4 Port Mapping

### 9.4.4.1 Port Mapping

#### Procedure

- Step 1 Click **Port Mapping** In the network interface, choose **Network > Port Mapping** to access the UPnP interface as shown in Figure 9-39

Figure 9-39 Port Mapping interface



- Step 2 Select manner from UPnP enable drop list. The default value is auto.  
 Step 3 After **UPnP** is manual, set the Web port, data port and client port manually.  
 Step 4 Click **Refresh** to restore previous settings. Click **Apply** to save the settings.



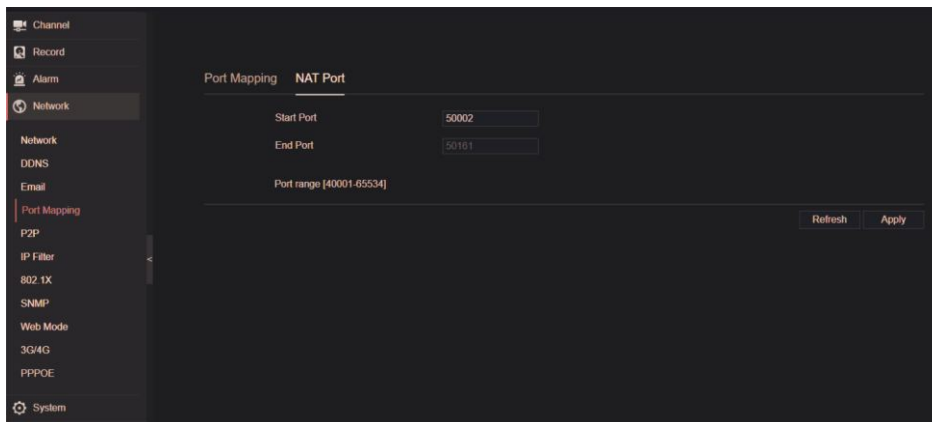
#### NOTE

- Auto: system perform UPnP automatically.
- Manual: the ports distribute by router, you need to refer router then input them.

### 9.4.4.2 NAT port

NAT (Network Address Translation), user can browse the web of camera by NAT port. There are five port can be assigned to each camera. Input the start port, the system will compute the end port automatically.

Figure 9-40 NAT port

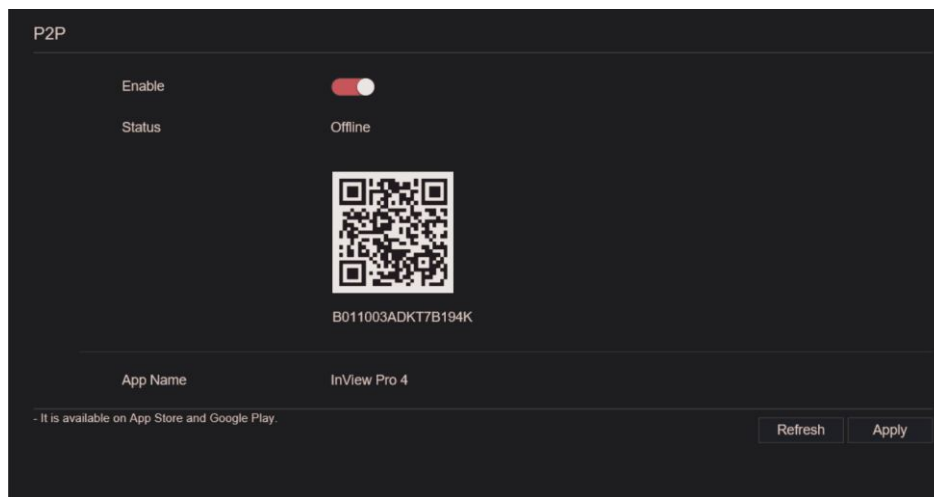


## 9.4.5 P2P

### Procedure

Step 1 Click **P2P** in the network interface, choose **Network > P2P** to access the P2P interface, as shown in Figure 9-41

Figure 9-41 P2P interface



Step 2 Click **Enable** to enable the P2P function.

Step 3 Click **Refresh** to restore previous settings. Click **Apply** to save the settings.

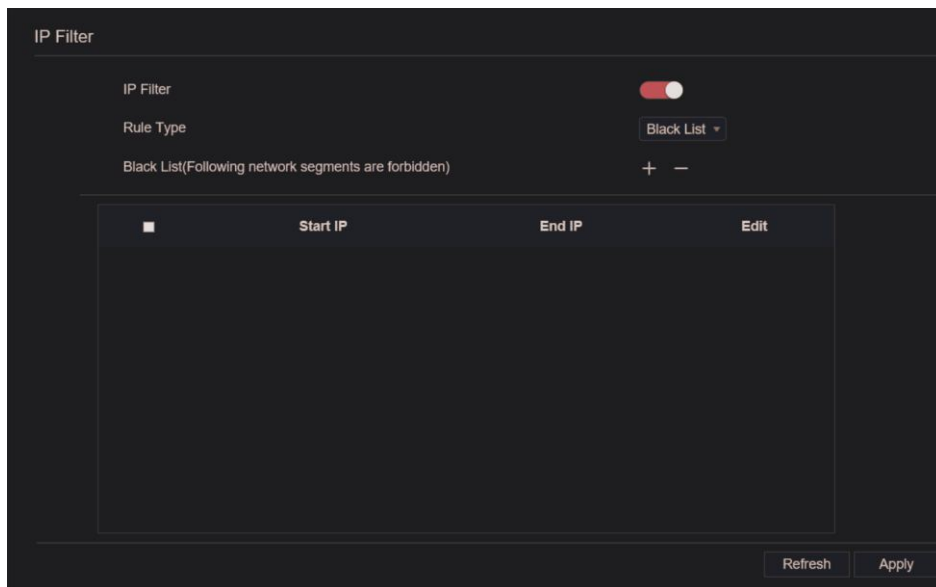
Step 4 After the InView Pro 4 is installed in mobile phone, run the APP and scan the UUID QR code to add then access the NVR when the device is online.

## 9.4.6 IP Filter

### Procedure

- Step 1 Click **IP Filter** in the network interface, choose **Network > IP Filter** to access the IP filter interface, as shown in Figure 9-42

Figure 9-42 IP filter interface





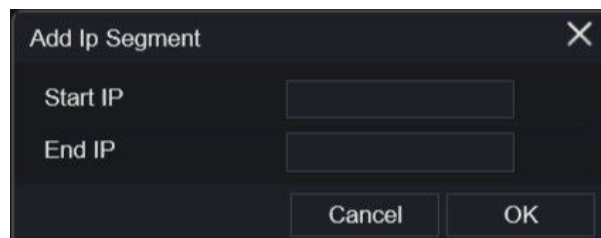
- Step 2 Click **Enable** to enable the IP filter function.
- Step 3 Click drop-down list of rule type to choose black list or white list.
- Step 4 Click  ,view the pop-up windows to set black list or white list, as shown in 7.5.4
- Click  to delete the list.

Figure 9-43 Black or white list interface



Step 5 Set start IP and end IP

Step 6 Click **Cancel** to deny settings, click **OK** to save the settings.

Step 7 Click **Refresh** to restore previous settings. Click **Apply** to save the settings.

#### **NOTE**

Black list: IP address in specified network segment to prohibit access.

White list: IP address in specified network segment to allow access.

Select a name in the list and click Delete to delete the name from the list.

Select a name in the list and click Edit to edit the name in the list.

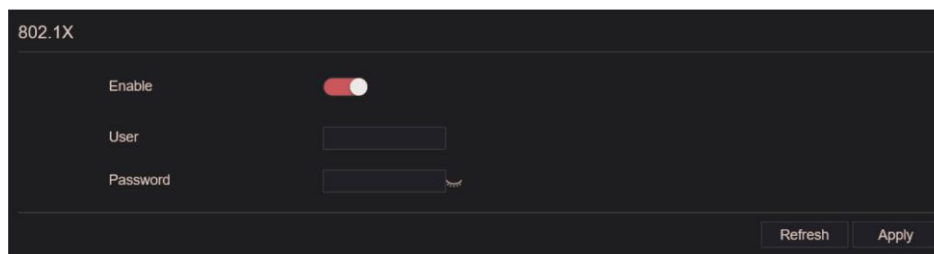
Only one rule type is available, and the last rule type set is efficient.

## 9.4.7 802.1X

### Procedure

Step 1 Click **802.1X** in the network interface, 802.1X interface is displayed, enable the button, as shown in Figure 9-44

Figure 9-44 802.1X interface



Step 2 Input the user and password of 802.1X authentication.

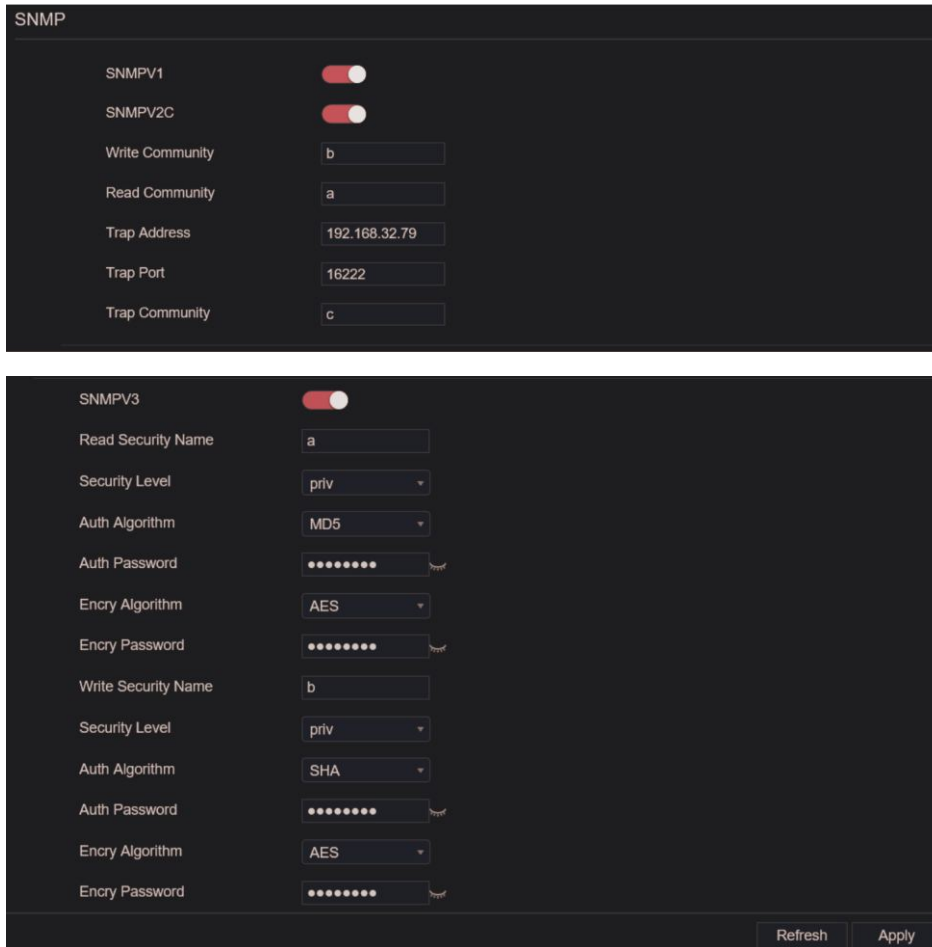
Step 3 Click **Refresh** to restore previous settings. Click **Apply** to save the settings.

## 9.4.8 SNMP

### Procedure

Step 1 Click **SNMP** in the network interface, SNMP interface is displayed, enable the button aside of SNMPV1, as shown in Figure 9-45

Figure 9-45 SNMP interface



The screenshot shows the SNMP configuration interface with the following settings:

- SNMPV1:** Enabled (toggle switch).
- SNMPV2C:** Enabled (toggle switch).
- Write Community:** b
- Read Community:** a
- Trap Address:** 192.168.32.79
- Trap Port:** 16222
- Trap Community:** c

**SNMPV3:** Enabled (toggle switch).

- Read Security Name:** a
- Security Level:** priv
- Auth Algorithm:** MD5
- Auth Password:** [Redacted]
- Encry Algorithm:** AES
- Encry Password:** [Redacted]
- Write Security Name:** b
- Security Level:** priv
- Auth Algorithm:** SHA
- Auth Password:** [Redacted]
- Encry Algorithm:** AES
- Encry Password:** [Redacted]

Buttons: Refresh, Apply

Step 2 Input the information of SNMP (simple network management protocol). there three types of that function. User can apply that if need.

Table 9-1 SNMP parameters

| Parameter             | Description                                  | Setting  |
|-----------------------|--|--|
| SMTP Server Address   | IP address of the SMTP server.               | [Setting method]<br>Enter a value manually.                          |
| SMTP Server Port      | Port number of the SMTP server.              | [Setting method]<br>Enter a value manually.<br>[Default value]<br>25 |
| User Name             | User name of the mailbox for sending emails. | [Setting method]<br>Enter a value manually.                          |
| Password              | Password of the mailbox for sending emails.  | [Setting method]<br>Enter a value manually.                          |
| Sender E-mail Address | Mailbox for sending emails.                  | [Setting method]<br>Enter a value manually.                          |

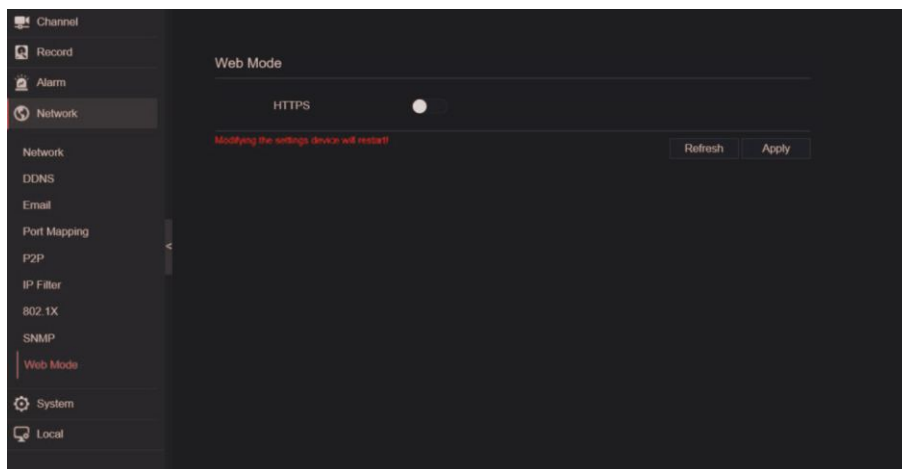
|                           |   |  |
|---------------------------|---|--|
| Recipient_E-mail_Address1 | (Mandatory) Email address of recipient 1.   | [Setting method]<br>Enter a value manually.  |
| Recipient_E-mail_Address2 | (Optional) Email address of recipient 2.  |  |
| Recipient_E-mail_Address3 | (Optional) Email address of recipient 3.  |  |
| Recipient_E-mail_Address4 | (Optional) Email address of recipient 4.  |  |
| Recipient_E-mail_Address5 | (Optional) Email address of recipient 5.  |  |
| Attachment Image Quality  | A higher-quality image means more storage space. Set this parameter based on the site requirement.    | N/A  |
| Transport Mode            | Email encryption mode. Set this parameter based on the encryption modes supported by the SMTP server. | [Setting method]<br>Select a value from the drop-down list box.<br>[Default value]<br>No Encrypted |

Step 3 Click **Refresh** to restore previous settings. Click **Apply** to save the settings.

### 9.4.9 Web Mode

Step 1 Click **Web Mode** in the network interface, Web mode interface is displayed, as shown in Figure 9-46

Figure 9-46 Web mode interface

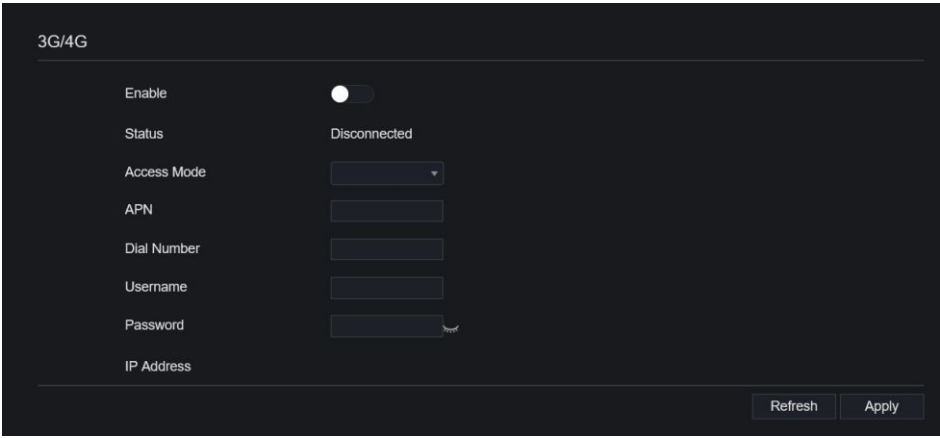


Step 2 Enable the https, the device will restart and start https secure.

Step 3 Click **Refresh** to restore previous settings. Click **Apply** to save the settings.

### 9.4.10 3G/4G

Figure 9-47 Web 3G/4G



|             |   |
|-------------|---|
| 3G/4G       |   |
| Enable      | <input type="checkbox"/>  |
| Status      | Disconnected  |
| Access Mode | <input type="text"/>  |
| APN         | <input type="text"/>  |
| Dial Number | <input type="text"/>  |
| Username    | <input type="text"/>  |
| Password    | <input type="password"/>  |
| IP Address  | <input type="text"/>  |
|             | <input type="button" value="Refresh"/> <input type="button" value="Apply"/> |

Step 1 The user plugs the modem to NVR.

Step 2 Enable the 3G/4G.

Step 3 When the status is connected, user can set the access mode, AUTO is recommended.

Step 4 If choose other access mode, user should input the parameter correctly.

Step 5 Click **Refresh** to restore previous settings. Click **Apply** to save the settings.

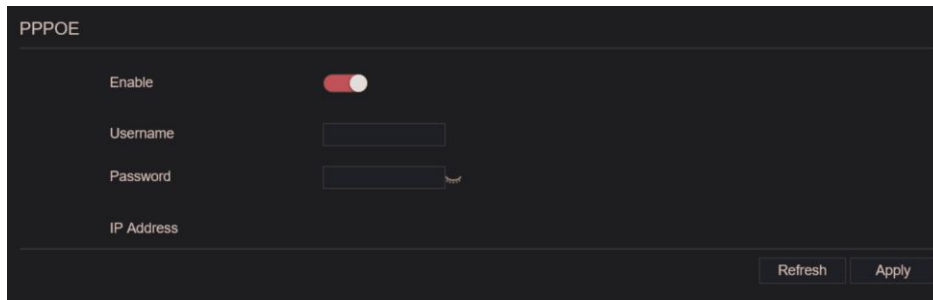
----End

### 9.4.11 PPPoE

User can use PPPOE function to manage the NVR conveniently.



Figure 9-48 PPPoE

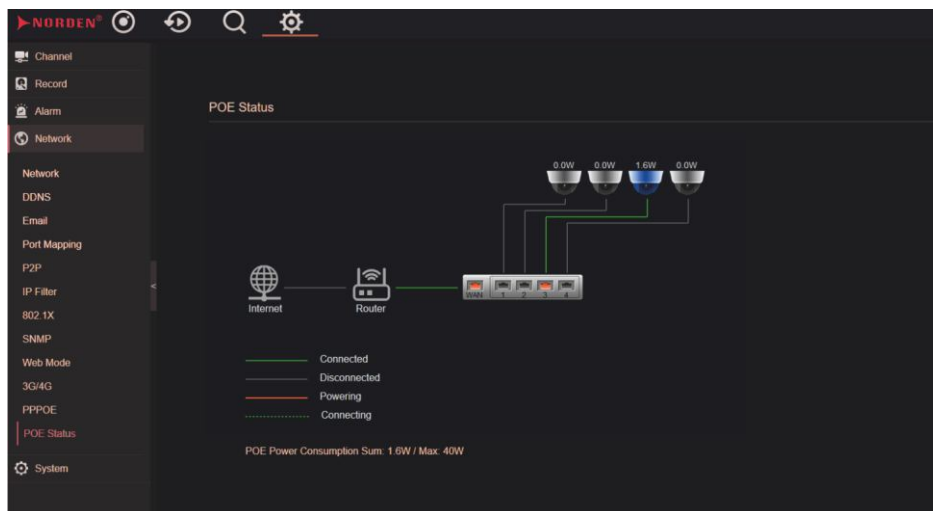


- Step 1 Enable the PPPoE.
- Step 2 Input the username and password.
- Step 3 The IP address is obtained automatically.
- Step 4 Click **Refresh** to restore previous settings. Click **Apply** to save the settings.
- Step 5 User use the IP address to access NVR immediately.

### 9.4.12 PoE Status (Only for Some Models)

User can view the POE status at this interface, as shown in Figure 9-49.

Figure 9-48 PPPoE



## 9.5 System

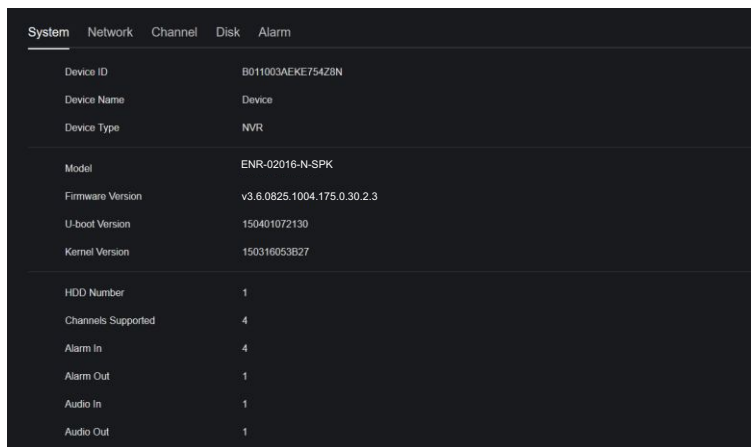
Users can set parameters about information, general, user, password, logs, maintenance and auto restart.

### 9.5.1 Device Information

Procedure

Step 1 Click  on the navigation bar, the device information interface is displayed, as shown in Figure 9-50.

Figure 9-50 Device information interface



| System             | Network                     | Channel | Disk | Alarm |
|--------------------|-----------------------------|---------|------|-------|
| Device ID          | B011003AEKE754Z8N           |         |      |       |
| Device Name        | Device                      |         |      |       |
| Device Type        | NVR                         |         |      |       |
| Model              | ENR-02016-N-SPK             |         |      |       |
| Firmware Version   | v3.6.0825.1004.175.0.30.2.3 |         |      |       |
| U-boot Version     | 150401072130                |         |      |       |
| Kernel Version     | 150316053B27                |         |      |       |
| HDD Number         | 1                           |         |      |       |
| Channels Supported | 4                           |         |      |       |
| Alarm In           | 4                           |         |      |       |
| Alarm Out          | 1                           |         |      |       |
| Audio In           | 1                           |         |      |       |
| Audio Out          | 1                           |         |      |       |

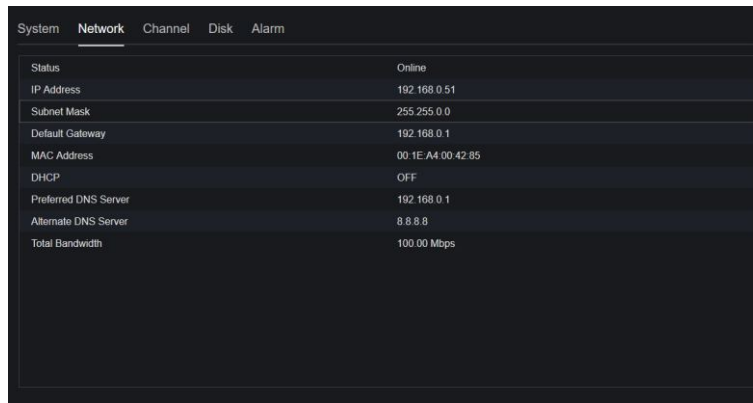
Step 2 Set the device name according to Table 9-2

Table 9-2 Device parameters

| Parameter        | Description   | Setting   |
|------------------|---|---|
| Device ID        | Unique device identifier used by the platform to distinguish the devices. | [Setting method]<br>The parameter cannot be modified.                             |
| Device Name      | Name of the device.   | [Setting method]<br><b>System Setting &gt; General</b><br>Modify the device name. |
| Device Type      | N/A   | [Setting method]<br>These parameters cannot be modified.                          |
| Model            |   |   |
| Firmware version |   |   |
| HDD volume       |   |   |
| Channel support  |   |   |

| Parameter | Description | Setting |
|-----------|-------------|---------|
| Alarm in  |             |         |
| Alarm out |             |         |
| Audio in  |             |         |
| Audio out |             |         |

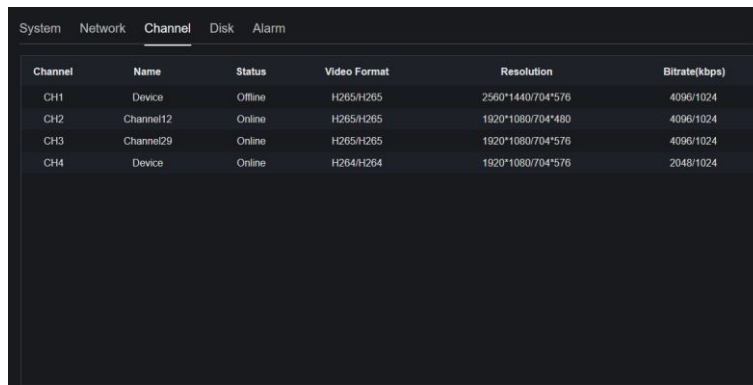
Figure 9-51 Network



System **Network** Channel Disk Alarm

|                      |                   |
|----------------------|-------------------|
| Status               | Online            |
| IP Address           | 192.168.0.51      |
| Subnet Mask          | 255.255.0.0       |
| Default Gateway      | 192.168.0.1       |
| MAC Address          | 00:1E:A4:00:42:85 |
| DHCP                 | OFF               |
| Preferred DNS Server | 192.168.0.1       |
| Alternate DNS Server | 8.8.8.8           |
| Total Bandwidth      | 100.00 Mbps       |

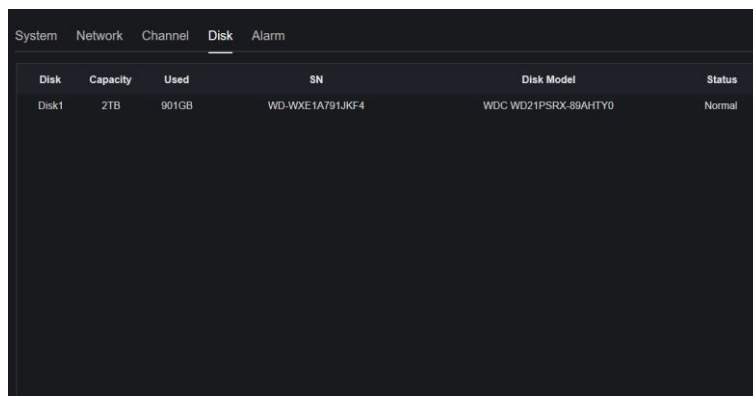
Figure 9-52 Channel



System Network **Channel** Disk Alarm

| Channel | Name      | Status  | Video Format | Resolution        | Bitrate(kbps) |
|---------|-----------|---------|--------------|-------------------|---------------|
| CH1     | Device    | Offline | H265/H265    | 2560*1440/704*576 | 4096/1024     |
| CH2     | Channel12 | Online  | H265/H265    | 1920*1080/704*480 | 4096/1024     |
| CH3     | Channel29 | Online  | H265/H265    | 1920*1080/704*576 | 4096/1024     |
| CH4     | Device    | Online  | H264/H264    | 1920*1080/704*576 | 2048/1024     |

Figure 9-53 Disk



System Network Channel **Disk** Alarm

| Disk  | Capacity | Used  | SN              | Disk Model          | Status |
|-------|----------|-------|-----------------|---------------------|--------|
| Disk1 | 2TB      | 901GB | WD-WXE1A791JKF4 | WDC WD21PSRX-89AHY0 | Normal |

Figure 9-54 Alarm

| Channel  | Name     | Mode  | Enable | Recording Channel |
|----------|----------|-------|--------|-------------------|
| Local-1  | Sensor 1 | N/O   | On     |                   |
| Local-2  | Sensor 2 | N/O   | On     |                   |
| Local-3  | Sensor 3 | N/O   | On     |                   |
| Local-4  | Sensor 4 | N/O   | On     |                   |
| Local->1 |          | Close |        |                   |

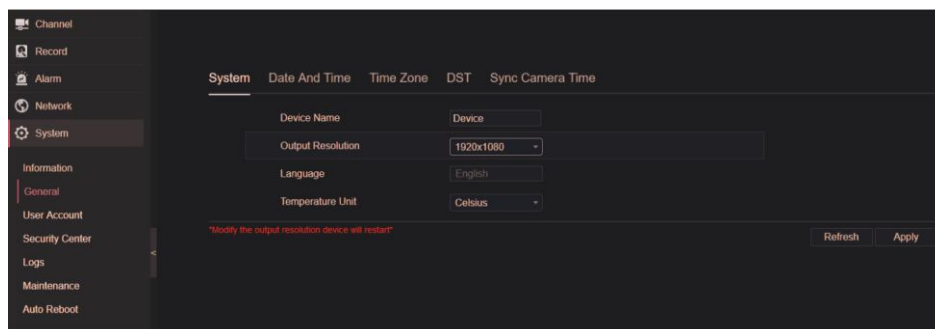
## 9.5.2 General

You can set system, date and time, time zone and DST general interface.

### Procedure

Step 1 On the **System Setting** screen, choose **System > General** to access the general interface, as shown in Figure 9-55

Figure 9-55 Basic setting interface



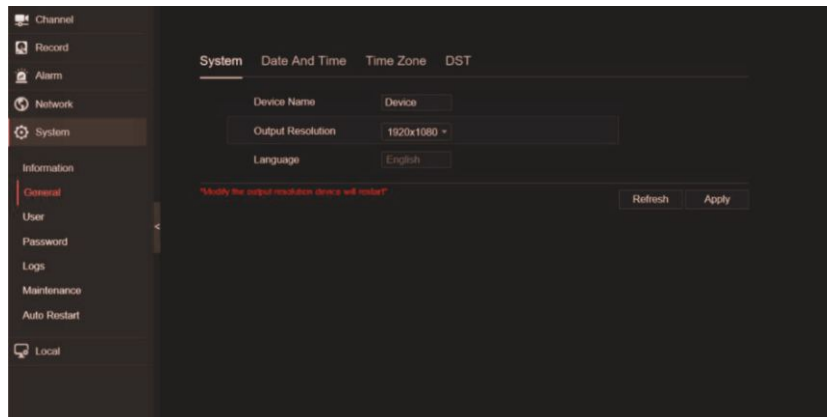
Step 2 Set system.

1. Input the device name.
2. Choose output resolution from drop list.
3. Click **Apply** to save the system setting.

Step 3 Set date and time

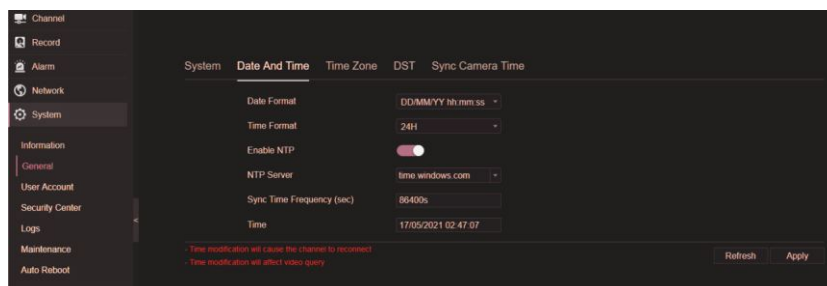
1. Synchronize the time from the NTP server.
2. Click NTP Sync button to enable synchronize time. The default value is enabling.

Figure 9-56 System interface



3. Select NTP server, date format and time format from drop list.
4. Click **Apply** to save date and time setting. The device time will synchronize with NTP server time.
5. Set the device time manually, as shown in .
6. Click NTP Sync button to disable synchronize time.
7. Async date and time interface

Figure 9-57 Date and time



#### Step 4 Set the time zone.

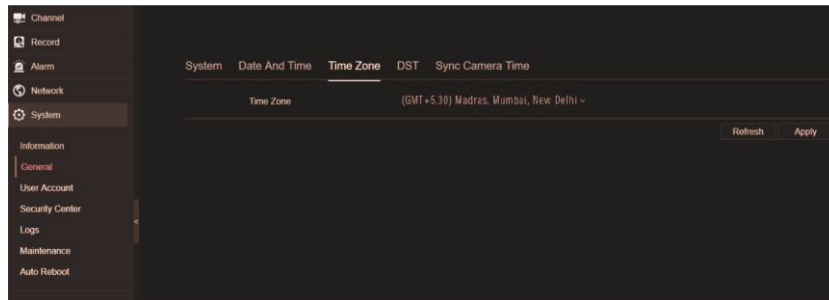
1. Select date format and time format from the drop-down list.
1. Click **Apply** to save the device time setting. Click **Refresh** to return to previous setting.

#### Step 5 Set time zone.

Click **Time Zone** to enter the time zone setting interface, as shown in Figure 9-58

Time zone setting interface

Figure 9-58 Time zone



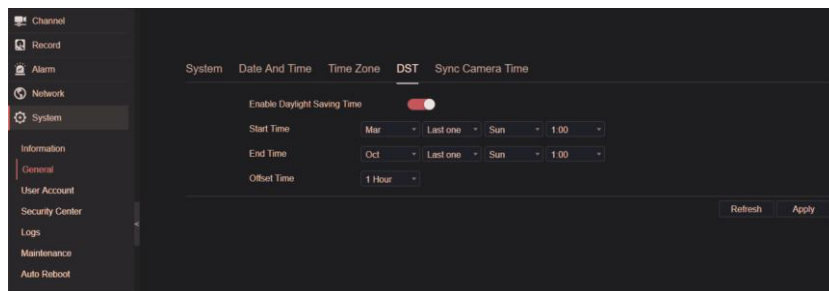
Select a time zone from the drop-down list.

Click **Apply** to save the time zone setting. Click **Refresh** to return to previous setting.

#### Step 6 Set DST

1. Click DST to enter the DST setting interface, click DST button to enable, as shown in Figure 9-59. The button is disabled by default.

Figure 9-59 DST setting interface

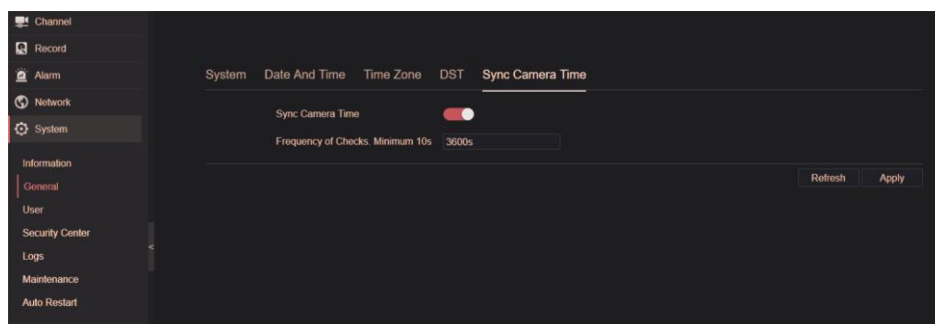


Select a start time from the drop-down list.

Select an end time from the drop-down list.

Select an offset time from the drop-down list.

Figure 9-60 Sync camera time



Enable sync camera time, the cameras of NVR management will be showing the same time.  
Set the frequency of checks (minimum 10s).

Step 7 Click **Apply** to save the DST setting. Click **Refresh** to return to previous setting.

## 9.5.3 User Account

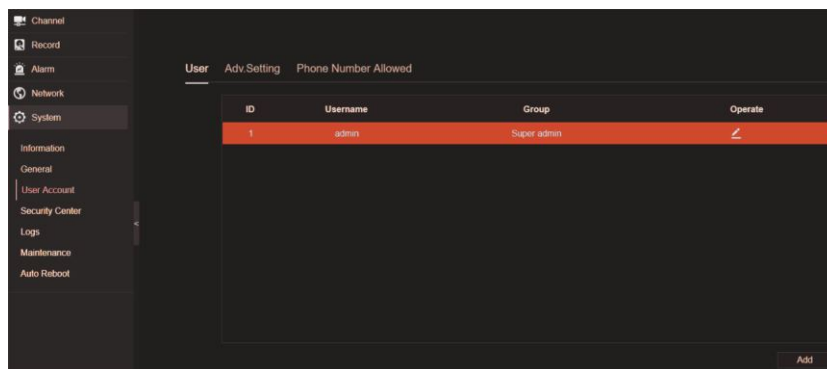
You can create new user accounts to manage the device.

### 9.5.3.1 Add User

Procedure

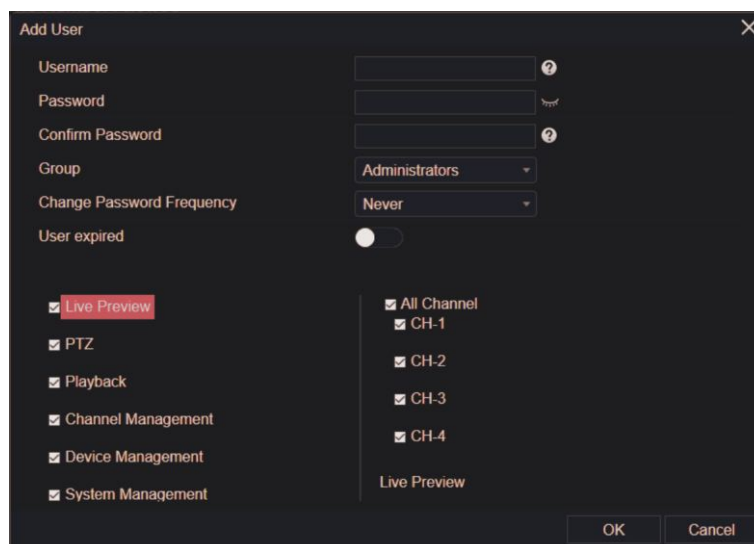
Step 1 On the **System Setting** screen, choose **System > User** to access the **User interface**, as shown in Figure 9-61

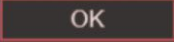
Figure 9-61 User interface

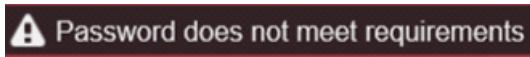



Step 2 Click Add to add a new user, as shown in Figure 9-62

Figure 9-62 Add User



- Step 3 Input username, password and confirm password.
- Step 4 Select group and change password reminder from drop-down list.
- Step 5 Assign the privilege to user.
- Step 6 Enable the expire date to set the new user's authority time.
- Step 7 Select channels to manage.
- Step 8 Click , the message "Add success" is showed. If the password is not meet the rule, it would show



- Step 9 Click  to edit user's information.

- Step 10 Click  to delete the account, it would show 

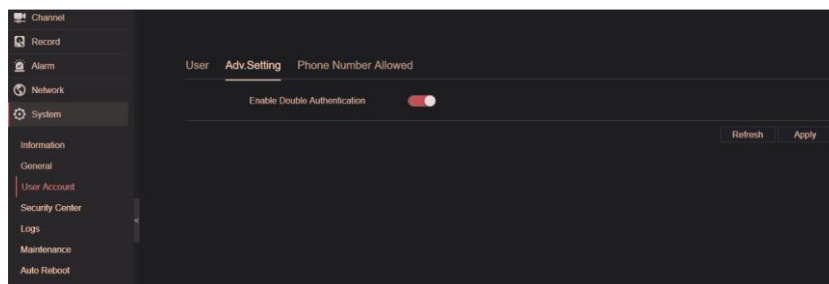
- Click  to delete.


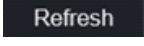
### 9.5.3.2 Adv. Setting

#### Procedure

- Step 1 On the **System Setting** screen, choose **System > User > Adv. Setting** to access interface, as shown in Figure 9-63

Figure 9-63 Adv. Setting interface



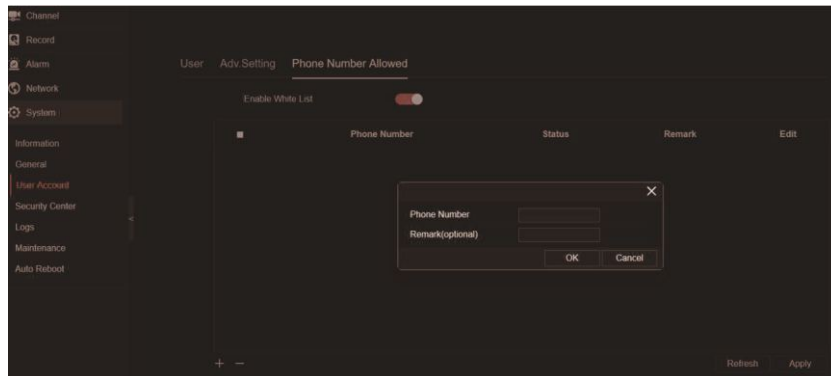
- Step 2 Enable the **Password double authentication**. If the user want to playback video, he need input another username and password to authenticate.
- Step 3 Click  to save the device time setting. Click  to return to previous setting.



### 9.5.3.3 App Verification

Add the digital number to white list, when the user login the cellphone App to manage the NVR, it must be input one series number in the white list to test and verify to keep the security.

Figure 9-64 Phone Number Allowed



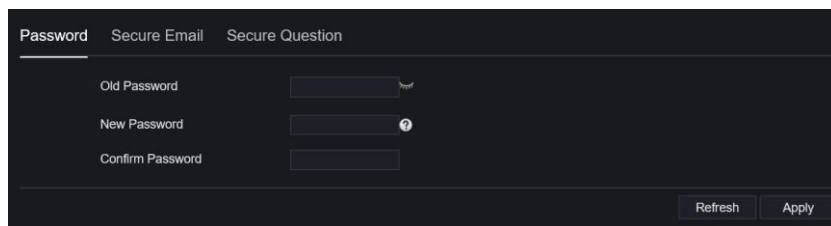
## 9.5.4 Security Center

### 9.5.4.1 Password

#### Procedure

Step 1 On the **System Setting** screen, choose **System > Security Center** to access password interface, as shown in Figure 9-65

Figure 9-65 Password interface



Step 2 Input old password, new password and confirm password.

Step 3 Click **Apply** to save settings. Click **Refresh** to return to previous setting.

#### NOTE

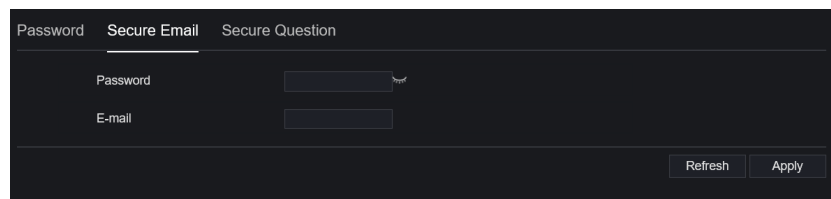
Valid password range [6-32] characters.

At least 2 kinds of numbers, lowercase, uppercase or special character contained.

Only special characters are support ! @#&\*+=-~%&"" (),/! .:;<>?^|~[]{}.

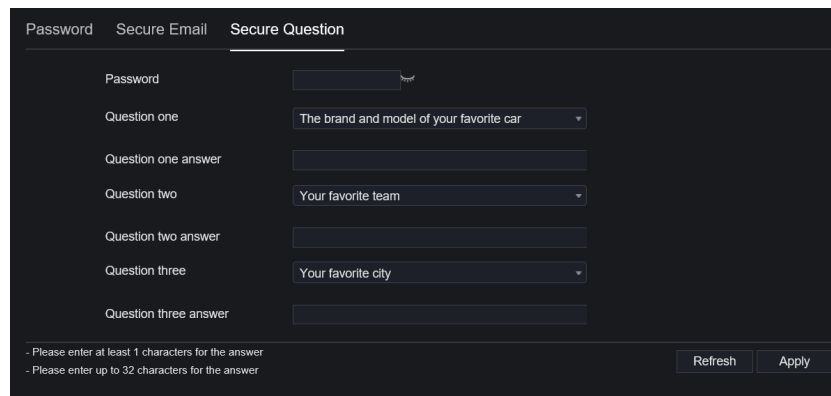
### 9.5.4.2 Secure Email

The secure email can receive the verification code of NVR, if user forgot the password accidentally.



### 9.5.4.3 Secure Question

User can modify the password to login the NVR if user forgot the password and answer correctly the secure questions.



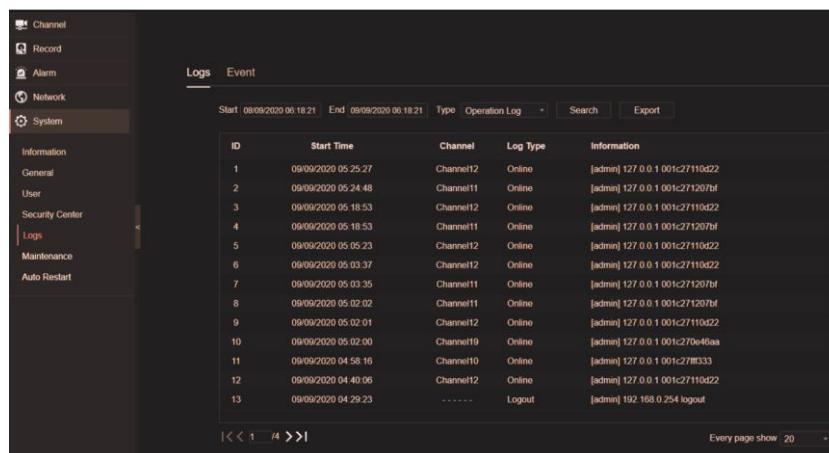
## 9.5.5 Logs

### 9.5.5.1 Logs

#### Procedure

Step 1 On the System Setting screen, choose System > Logs to access logs interface, as shown in Figure 9-66

Figure 9-66 System log interface



| ID | Start Time          | Channel   | Log Type | Information                    |
|----|---------------------|-----------|----------|--------------------------------|
| 1  | 09/09/2020 05:25:27 | Channel12 | Online   | [admin] 127.0.0.1 001c27110d22 |
| 2  | 09/09/2020 05:24:48 | Channel11 | Online   | [admin] 127.0.0.1 001c271207bf |
| 3  | 09/09/2020 05:18:53 | Channel12 | Online   | [admin] 127.0.0.1 001c27110d22 |
| 4  | 09/09/2020 05:18:53 | Channel11 | Online   | [admin] 127.0.0.1 001c271207bf |
| 5  | 09/09/2020 05:05:23 | Channel12 | Online   | [admin] 127.0.0.1 001c27110d22 |
| 6  | 09/09/2020 05:03:37 | Channel12 | Online   | [admin] 127.0.0.1 001c27110d22 |
| 7  | 09/09/2020 05:03:35 | Channel11 | Online   | [admin] 127.0.0.1 001c271207bf |
| 8  | 09/09/2020 05:02:02 | Channel11 | Online   | [admin] 127.0.0.1 001c271207bf |
| 9  | 09/09/2020 05:02:01 | Channel12 | Online   | [admin] 127.0.0.1 001c27110d22 |
| 10 | 09/09/2020 05:02:00 | Channel19 | Online   | [admin] 127.0.0.1 001c270e46aa |
| 11 | 09/09/2020 04:58:16 | Channel10 | Online   | [admin] 127.0.0.1 001c2783333  |
| 12 | 09/09/2020 04:40:06 | Channel12 | Online   | [admin] 127.0.0.1 001c27110d22 |
| 13 | 09/09/2020 04:29:23 | -----     | Logout   | [admin] 192.168.0.754 logout   |

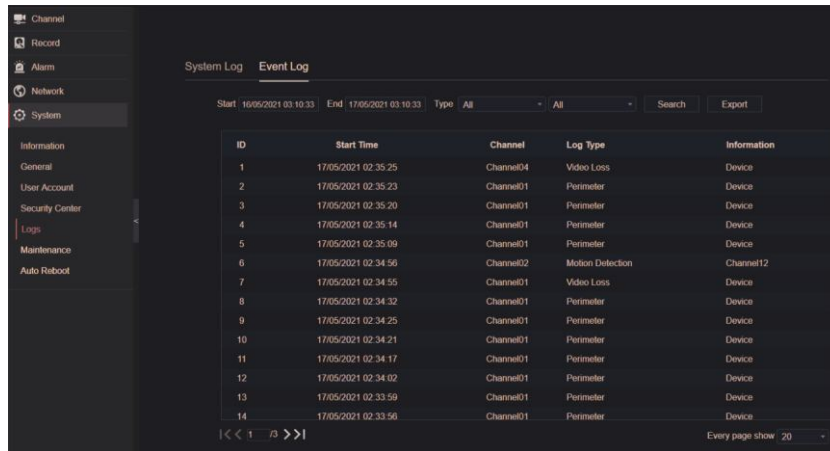
- Step 2 Set start and end time from calendar.
- Step 3 Select log type from drop-down list.
- Step 4 Click **Search** to acquire log information.
- Step 5 Click **Export** to export the logs.

### 9.5.5.2 Event

#### Procedure

Step 1 On the **System Setting** screen, choose **System > Logs > Event** to access logs interface, as shown in Figure 9-67

Figure 9-67 Event log interface



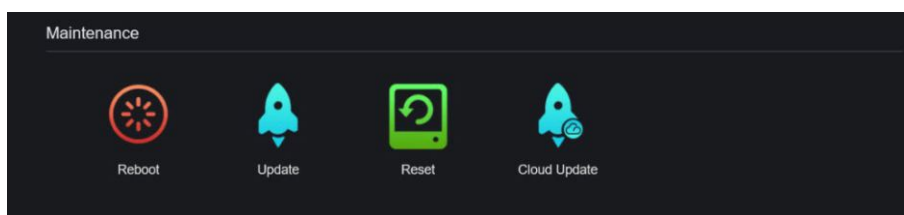
- Step 2 Set start and end time from calendar.
- Step 3 Select event type from drop-down list.
- Step 4 Click **Search** to acquire log information.
- Step 5 Click **Export** to export the event logs.

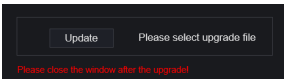
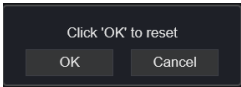
## 9.5.6 Maintenance

### Procedure

- Step 1 On the **System Setting** screen, choose **System > Maintenance** to access maintenance interface, as shown in Figure 9-68

Figure 9-68 Maintenance interface



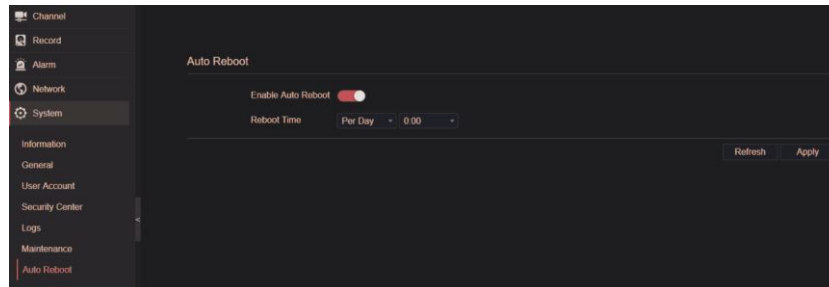
- Step 2 Click **Reboot**, the pop-up message would show you, click **OK** to reboot.
- Step 3 Click **Update**, the message shows , choose software from specific location to update.
- Step 4 Click **Reset**, the pop-up message  shows to you, click **OK** to reset.
- Step 5 If the device is online, and the cloud server has the software, click the **Cloud Update**, it shows 'make sure to update', click **OK** to update.

## 9.5.7 Auto Reboot

### Procedure

Step 1 On the **System Setting** screen, choose **System > Auto Reboot** to access auto restart enable the auto restart, the screen as shown in Figure 9-69

Figure 9-69 Auto restart



Step 2 Select one type of restart time from drop-down list.

Step 3 Click **Apply** to save settings. Click **Refresh** to return to previous setting.

## 9.6 Local (Supplied for IE Browser)

Set the image download path for snapshot and the record download path for record files in the download configuration interface.

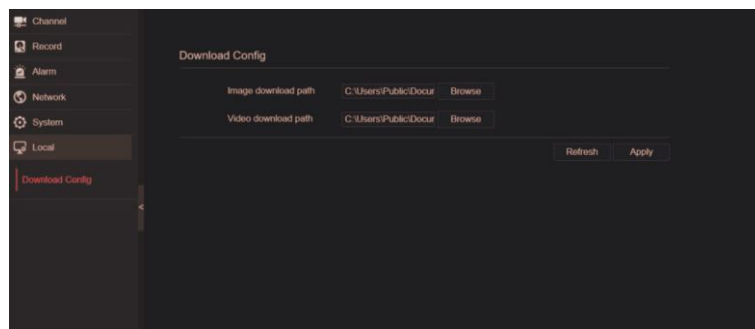
### NOTE

This function is only used for IE browser.

### Procedure

Step 1 Click **Local Download Config** in local interface, as shown in Fig 9-70 .

Figure 9-70 Local interface



Step 2 Enter the image download path.

Step 3 Enter the record download path.

Step 4 Click **Refresh** to return the previous settings. Click **Apply** to save the settings.

## 10.Disk Compatibility

The hard disks in the following list are tested and certified by our company, if you want to use other hard disks, please consult to our technical staff.

| Part Number   | HDD Brand | HDD model         | Capacity    |
|---|-----------|-------------------|-------------|
| ENR-01004-N-FK<br>ENR-01008-N-FK<br>ENR-01004-N-FPK<br>ENR-01008-N-EPK<br>ENR-02008-N-EPK<br>ENR-02016-N-FK<br>ENR-02016-N-SPK<br>ENR-02032-N-FK<br>ENR-02032-N-SPK<br>ENR-01004-N-PPK<br>ENR-04032-N-FRK<br>ENR-04032-N-SPK<br>ENR-04032-N-GPK<br>ENR-04032-N-GK<br>ENR-08032-N-FRK<br>ENR-08064-N-FRK | WD        | WD30EJRX-89G3VY0  | 3T          |
|   |           | WD10EJRX-89N74Y0  | 1T          |
|   |           | WD40PURX-64GVNY0  | 4T          |
|   |           | WD20EURS-63S48Y0  | 2T          |
|   |           | WD20EJRX-89AKWY0  | 2T          |
|   |           | WD30EURS-63SPKY0  | 3T          |
|   |           | WD5000AAKK-001CA0 | 0.5T        |
|   |           | WD10EZEX-00BN5A0  | 1T          |
|   |           | WD40EJRX-89T1XY0  | 4T          |
|   |           | WD30PURX-64P6ZY0  | 3T          |
|   |           | WD60PURX-64WYOY1  | 6T          |
|   |           | WD82EJRX-89AD9Y0  | 8T          |
|   |           | WD121EJRX-89S5UY0 | 12T         |
|   | WD41PSRX  | WD41PSRX          | 4T/6T/2T/1T |
|   | Seagate   | ST2000VX000       | 2T          |
|   |           | ST2000VX008       | 2T          |
|   |           | ST4000VX000       | 4T          |
| ST3000VX000   |           | 3T                |             |
| ST4000VX007   |           | 4T                |             |
| ST3000VX010   | 4T        |                   |             |

|   |         |                   |     |
|---|---------|-------------------|-----|
|   |         | ST31000528AS      | 1T  |
|   |         | ST6000VX0001      | 6T  |
|   |         | ST3000VX010       | 3T  |
|   |         | ST8000VX0002      | 8T  |
|   |         | ST6000VN0011      | 6T  |
|   | Toshiba | DT01ABA100V       | 1T  |
| ENR-02008-N-EPK<br>ENR-02016-N-SPK<br>ENR-02032-N-SPK<br>ENR-04032-N-SPK<br>ENR-04032-N-GPK | WD      | WD121EJRX-89S5UY0 | 12T |
|   |         | SC Ha710          | 12T |

**\*\*Only 4/8 Bay HDD NVR support RAID**

Video recording size per channel per hour = bitrate (kbps)\*3600/1200/8 (M)

Recording duration = Total hard disk capacity (M) / Video recording size per channel per hour / number channels (H)